

Technical Bulletin

Arsenic Removal by INDION ASM (Arsenic Selective Media)

Contents

- Introduction
- Arsenic removal methods
- Basics of INDION ASM
- INDION ASM- unique features
- Design guidelines
- System hydraulics
- Domestic & Community Applications
- Field trials
- Commercial Success
- Pre-treatment requirements
- Packaging, storage and safety

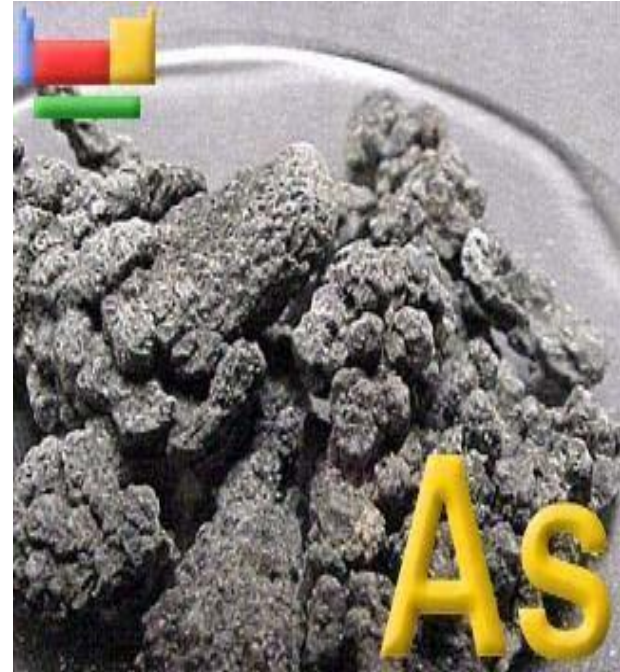

Introduction

Arsenic contamination is a serious problem found in ground water in Eastern part of India i.e. West Bengal and also in countries such as Bangladesh, Poland, Canada, China, Vietnam, Taiwan, Central America, Thailand and Japan.

The normal concentration of arsenic is around 0.1 to 1.5 ppm and in most areas it varies from 0.2 to 0.5 ppm. It is found to be maximum i.e. 3.0 ppm in West Bengal.

The World Health Organization (WHO), EPA and BIS current provisional guideline for arsenic in drinking water is 10 ppb.

Excess intake of arsenic leads to skin diseases like hyper pigmentation, keratoses, melanomas, cardiovascular, renal, hematological, respiratory disorders and cancer.

GLOBAL REVIEW OF ARSENIC AFFECTED AREAS

Country / Region	Population Exposed (millions)	Concentration Range µg/l	Groundwater Properties	Other Dissolved Ions
Bangladesh	30	< 0.5 – 2500	Strongly reducing conditions, neutral pH, high alkalinity	High Fe
West Bengal	6	< 10 – 3200	As for (27% >50 µg/L)	High Fe
China	5.7	10 – 1820	Strongly reducing artesian conditions	
Argentina(Chaco Pampean Plain)	2	< 1 – 5300	Oxidising conditions, neutral to high pH, high alkalinity, arsenic present mainly as As(V)	
Mexico (Lagunera)	0.4	8 – 620	Oxidising conditions, neutral to high pH, arsenic present mainly as As(V)	Low concentration of dissolved Fe and Mn
Northern Chile (Antofagasta)	0.5	100 – 1000	Oxidizing conditions, high pH: arsenic present mainly as As(V)	
Red River Delta, Vietnam	> 10	1 – 3050	Reducing conditions, high alkalinity	High concentrations of Fe, Mn, NH ₄
USA river water, baseline	----	2.1	----	-----

GLOBAL REVIEW OF ARSENIC AFFECTED AREAS

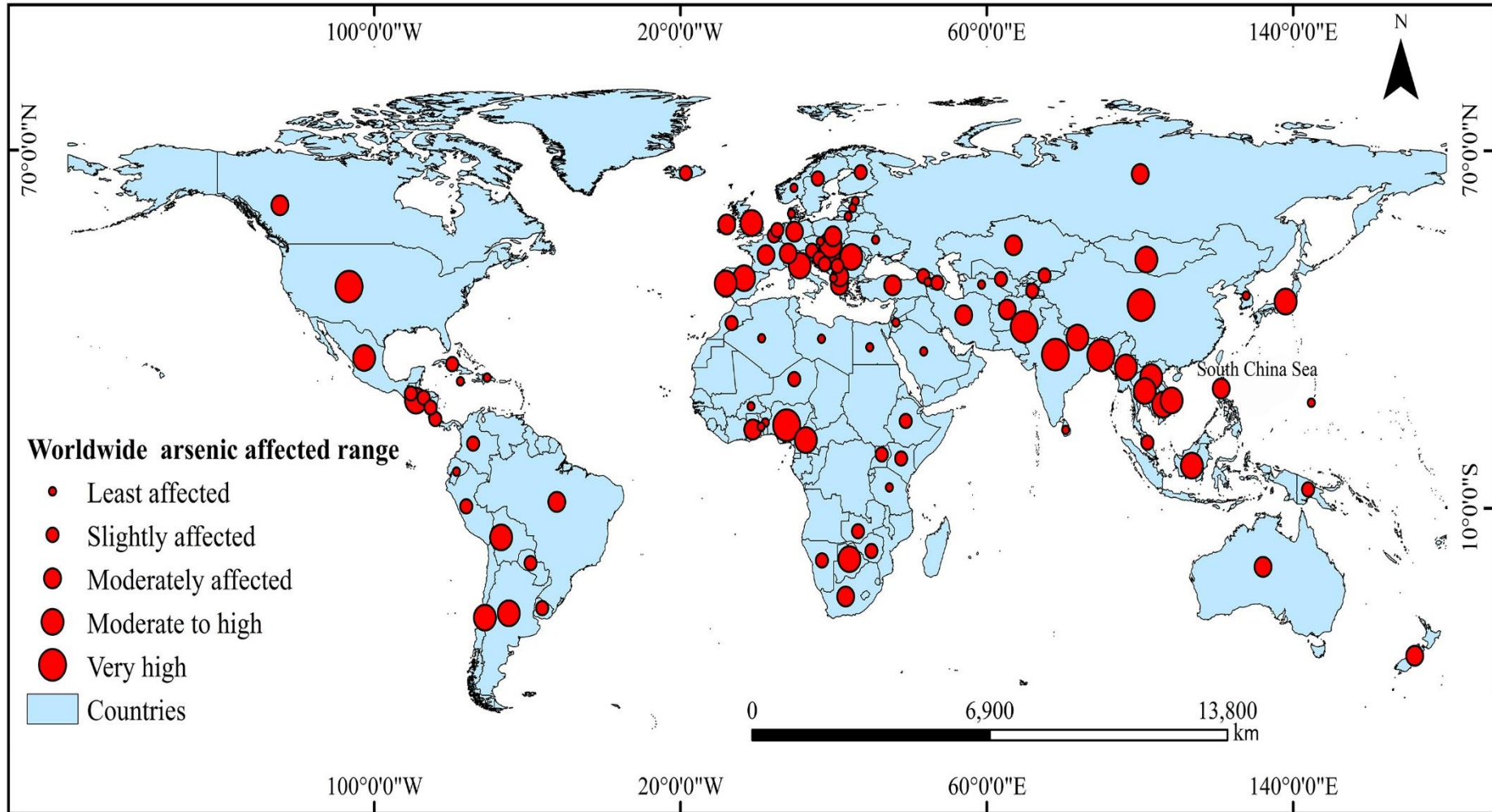

CONVENTIONAL ARSENIC REMOVAL METHODS

Various treatment technologies have been developed to remove arsenic from ground water. Following methods are available for removal of arsenic from water for potable use.

Chemical Precipitation

Chemical precipitation with iron salts followed by filtration is widely used technique in large municipal water treatment and requires an oxidation pretreatment to convert As(III) into As (V).

Removal efficiency is 80 to 95 %, and requires high capital and operating cost.

Ion exchange process

Anion exchange medias have been used for removal of arsenic.

Commonly occurring anions, TDS strongly reduce arsenic removal potential.

Biological Processes

Certain bacteria can bring about the oxidation of ferrous ions which can remove arsenic by either co-precipitation or adsorption. Rapid gravity or pressure sand filters are used as biological reactors.

The process is viable for only community level and maintenance of biological plant is very critical.

ARSENIC REMOVAL METHODS

Adsorption Process

Arsenic can be removed by adsorption on to several media mainly activated alumina, granulated ferric hydroxide, activated carbon, activated bauxite, hematite, laterite, iron and manganese coated sand, iron filings and greensand, ion exchange media. Polymer supported hydrated ferric oxide particles.

High turbidity, high concentration of iron and other dissolved salts and pH affect the life of media.

Membrane Processes

Reverse osmosis and nanofiltration can remove arsenic efficiently.

High capital and operating cost. Disposal of membrane reject water is critical.

Basics of INDION ASM

INDION ASM* (Arsenic Selective Media) is based on ion exchange media designed to selectively remove arsenic from ground water without affecting the characteristics of influent water . INDION ASM performs well in spite of the presence of common anions such as chlorides, sulphates or bicarbonates. INDION ASM is used like conventional ion exchange medias.

In past decades, adsorption on hydrated Fe (III) oxide (HF0) has been a widely used and accepted process for arsenic removal.

As non porous material, freshly precipitated amorphous HF0 (20 -100 nm) increases the pressure drop and due to it's poor mechanical strength, it is found unusable for fix bed system.

To overcome the problem, INDION ASM is developed by a novel technique by impregnating nano particles of iron on polymer supporting material.

Arsenic removal was evaluated by batch and fixed bed column test at laboratory Results indicated that hydrated ferric oxide sorbent exhibited an excellent sorption for arsenic removal in terms high capacity, improved selectivity and good mechanical strength.

Field trials at Haldharpada - West Bengal (India) also proved its excellent selectivity for arsenic removal without alternating water quality

*- INDION ASM is a patented product of Ion Exchange (I) Ltd.

INDION ASM - Unique Features

- No pretreatment is required for conversion of arsenite to arsenate.
- Media has affinity towards trivalent and pentavalent arsenic and can tolerate maximum 3000 ppb of arsenic.
- Media can treat >50,000 BV where inlet is 50 ppb As⁺⁵ and TDS levels are between 50-100 ppm
- Single use or once through application.
- Media can give < 10 ppb arsenic in treated water on continuous basis as per BIS drinking water standards.
- It is easily adaptable and can be used for POE, POU and community based needs.
- Media can effectively adsorb arsenic at lower temperature (12-15C)
- Excellent efficiency even at a Minimum bed depth of 200-250 mm (POU)
- Minimum contact time required for arsenic removal process is 1-5 minutes(typically 3 minutes).
- Media can give 20% more capacity with on/off condition.
- Can remove multiple contaminants with lead and lag system.



Unique Features - NANO MEDIA

NSF-61, Gold seal
Certification by WQA



Heavy Metal
Removal (Lead,
Copper
Chromium,
Cadmium etc)

Removal of Other
contaminants such
as
Phosphate, Nitrate.

Media is CSIR approved & Certified
'Nanoadsorbent' by INST (Institute of Nano
Science and Technology, Punjab)

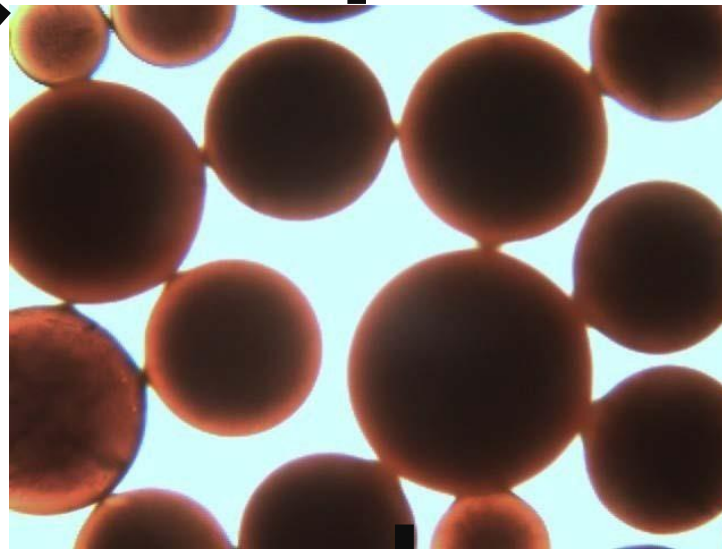

High Arsenic Selectivity
. No affinity towards
common anions

Excellent
Adaptability and
can be used in
conventional
cartridges, filters,
community and
POE units.

Easy Disposal. Non-hazardous

Excellent Hydraulics and Fast kinetics.
No Pre-chlorination required

Good physical and
mechanical strength

TECHNICAL SUPERIORITY

	INDION ASM	Granular Ferric Oxide GFO
Contact Time (minutes)	1-5	3
Backwash Frequently	NO	YES
Excellent Hydraulics	YES	NO
Adsorptive Properties	YES	NO
Regenerability	Regenerable/Multiple Use	NO
Landfill Safe*	YES	NO

* - Media has passed TCLP as per EPA 1311

DESIGN GUIDELINE

PHYSICAL CHARACTERISTICS

Polymer Structure	Styrene/DVB
Colour	Reddish Brown
Physical form	Moist Beads
Matrix	Gel
Wet screen grading	0.3-1.2mm (14- 52 BSS mesh size)
Osmotic Strength	Good
Mechanical strength	Good
Voids	40% approximately
Bulk Density	0.8 kg/lit
Particle Density (Wetted in water).	1.14 kg/lit
Uniform coefficient	1.7max
Effective size	0.45-0.5mm
Water Retention	50-55 %
Solubility	Insoluble
Approximate Shipping weight	49 lbs/ft ³

FEED WATER REQUIREMENTS

Presence of common ions, ordinarily found in drinking in water, such as, sodium, bicarbonate, chloride and sulfate do not possess any interference because of their reduced affinity towards INDION ASM. Total Dissolved solids level (TDS) should be within 1000 ppm – 1200 ppm (Max) and no single ion concentration greater than 1000 ppm.

Although substances such as Silica, Phosphate , Nitrate and other oxy-anions compete with Arsenic for adsorption sites, tending to reduce the capacity, the effect is not pronounced if their levels are within acceptable limits.

In addition, no pretreatment is required for conversion of arsenite to arsenate. Arsenic treatment unit will take care of the conversion as well as Iron removal simultaneously.

It is also recommended to ensure that the level of suspended solids or substances that tend to precipitate during the loading process such as Iron, be removed by pretreatment using INDION ISR (Iron Specific media), as these solids tend to occupy the void spaces and start accumulating over bed surface over a period of time.

LIMITING FACTORS

Phosphate, Nitrate and Silica compete for adsorption sites. Although Phosphate and Nitrate form complex anions or colloids combining with other cations and do not bind with the media, we suggest a phosphate concentration < 25 ppm and nitrate concentration < 50 ppm. Media can be used effectively, without any pre-treatment if concentration of these ions are well below the limit.

Although increasing pH reduces the capacity, INDION ASM is operable in a wide range of pH (4.5-9.0). At Lower pH, presence of competing ions is minimal but as pH rises, their effect reduces the capacity. Any system intended to operate at a pH below 4.5 or above 9.0 should be reviewed with Ion Exchange Technical Executives. Unstable pH levels during the service cycles can lead to unstable performance resulting in reduced efficiency.

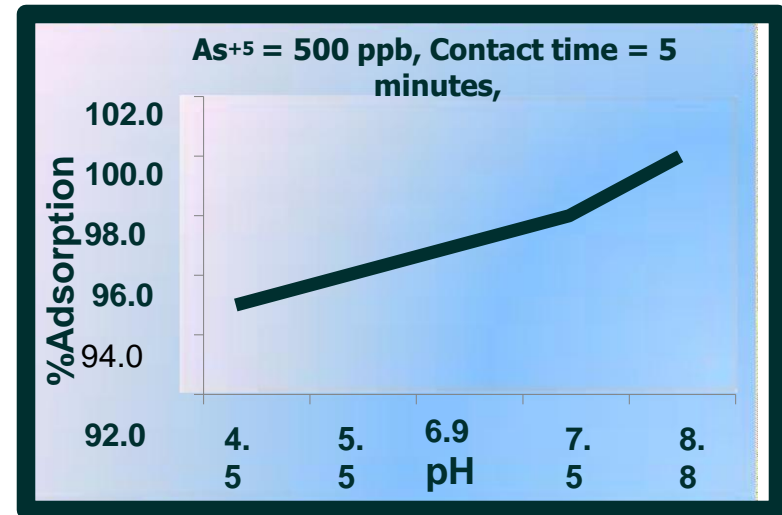
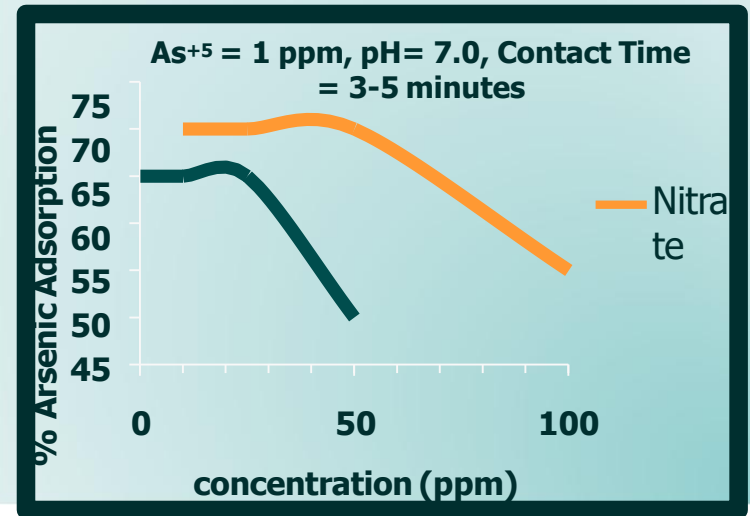

...DESIGN GUIDELINES

FEED WATER REQUIREMENTS

▪.pH	5.5-9.0
▪.TDS ppm	<1000.0
▪.Turbidity NTU	5.0 max
▪.SS ppm	<5.0 max
▪.Organics ppm	Nil
▪.Oil & grease ppm	Nil
▪.Silica ppm as SiO ₂	25 max
▪.Phosphate ppm as PO ₄	25-30 max
▪.Nitrates ppm as NO ₃	30-35 max
▪.Arsenic ppm	3.0 max
▪.Iron ppm	<0.5 max
▪.Manganese	<0.5 max

Arsenic Concentration (ppb)	Expected Throughput (Bed Volumes)
50	40,000-45000
100	20,000-23000
200	10,000-12000
500	4000-4500
600	3000-3500
1000	2000-2500

SUGGESTED OPERATING CONDITIONS

Bed depth	0.5 -1 m minimum
Service velocity	15-22 m/h
Backwash velocity	8-10m/h
Backwash bed expansion	30 -40 %
Backwash time	15-20 minutes
Backwash Frequency	every 1000 BV
Temperature range	35-40° C

REGENERATION

Media is suitable for once through application

DISPOSAL

Exhausted INDION ASM is non toxic and safe for disposal as per TCLP, EPA 1311. Also, follow local regulations or consult Ion Exchange executives for further information.

SYSTEM HYDRAULICS

Pressure drop of ASM media at various temperatures

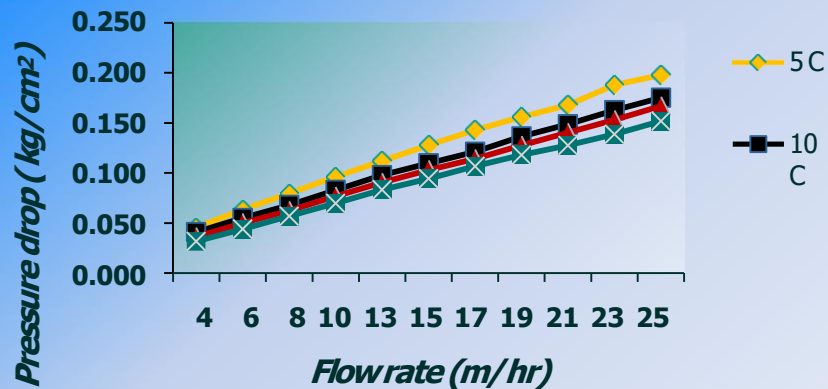

PRESSURE DROP

This graph can be employed to estimate the pressure drop at various temperatures for different flow rates.

BACKWASH

After specific intervals, to loosen the bed, Back wash is recommended. Graph indicates the percent expansion of bed at various flow rates.

Note: for approximate conversion, use the following factor
 1. 1 gpm/sq.ft = 18.292 m/h
 2. 1 psi/ft = 0.070306 kg/cm²)

Percent bed expansion at various flow rates

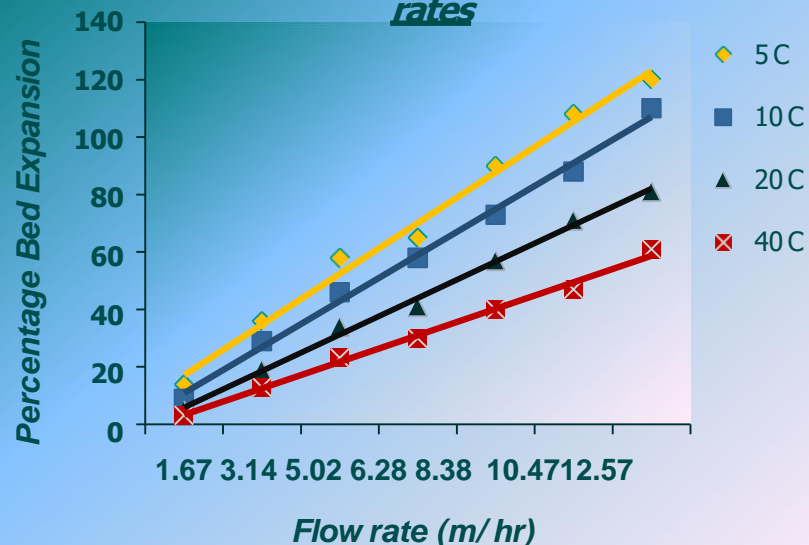

COMMUNITY BASED LEAD AND LAG SYSTEM

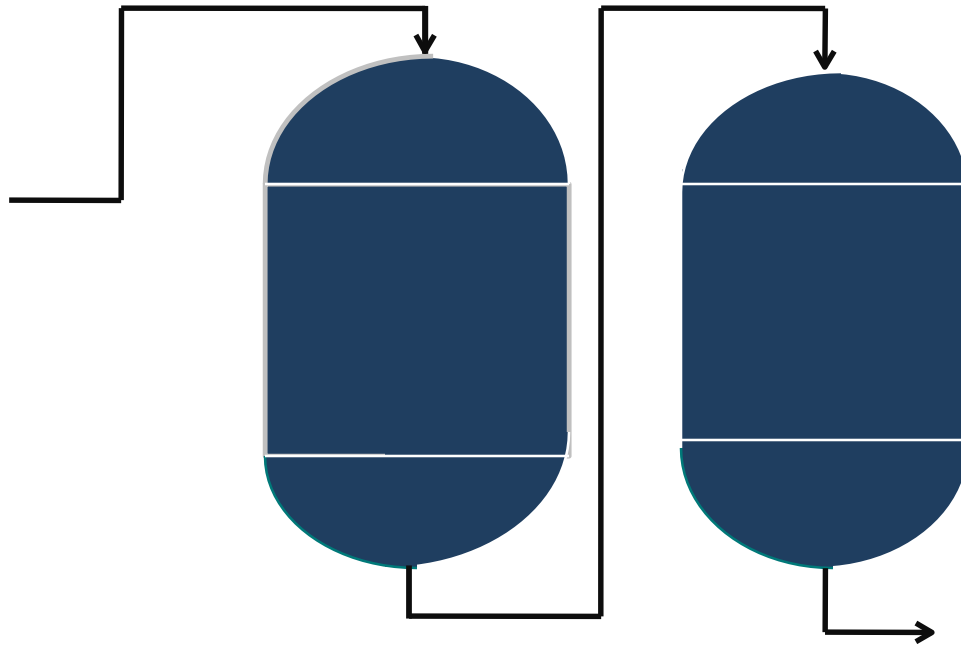

- Typically 3-4 minutes contact time
- Bed depth – 1m minimum
- Distributor Design for 13-52 mesh media
- Sample ports inlet /outlet (both)
- Consult our executives for detail design
- Single or Multiple use
- Design like typical ion exchange vessels

On Exhaustion of lead, replace lead with lag and put a fresh vessel in lag position

POINT OF ENTRY (POE UNITS)

INDION ASM has been tested at West Bengal-Haldharpada in Hand-pump Attachment Unit and POU (Point of Use Device). The arsenic concentration in both water bodies ranges from 150-200 ppb, concentration in treated water was consistently less than 10 ppb, which confirms the drinking water standard as per USEPA as well WHO & BIS.

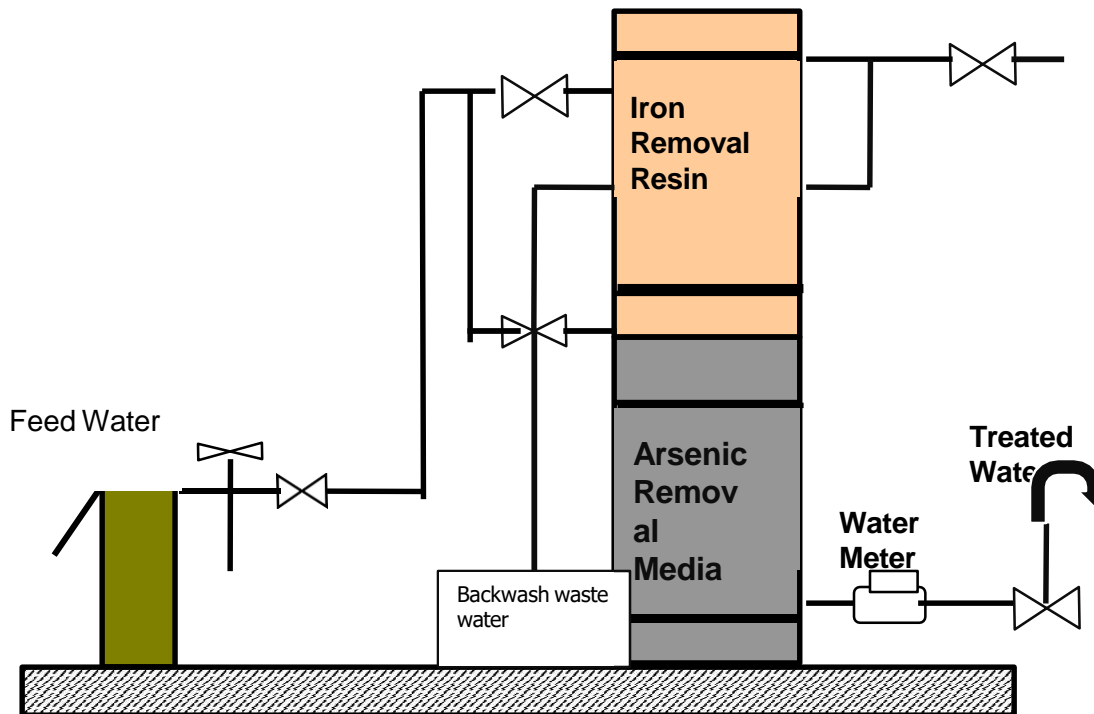

Arsenic Removal system consists of two media in series:

1. Iron removal unit consist of INDION ISR resin(ISR).

2. Arsenic Selective Media(INDION ASM)

The flow of unit is 10-15 l/min. This flow is selected considering the standard hand pump design.

- ISR - It oxidizes dissolved iron into precipitate form and filters it to give iron below 0.3 ppm at the outlet. The media also oxidises trivalent arsenic(Arsenic III) present in water to pentavalent arsenic (Arsenic V) which can easily be adsorbed by ASM. Part of the arsenic co-precipitates with Iron
- INDION ASM – Selectively adsorbs arsenic from water without changing water quality parameters.

Performance of media can be monitored using arsenic test kits.

Field Trials At Haldharpada (West Bengal)

Field trials were conducted at Haldharpada- West Bengal with Hand pump attachment unit . HPA consists of Iron removal media(INDION ISR) followed by Arsenic removal media(INDION ASM) .

Figure 1 shows dissolved arsenic concentration in both contaminated groundwater (i.e. influent) and treated water . The arsenic concentration in both water bodies ranges from 150-200 ppb, and the concentration in treated water was consistently less than 10 ppb, which confirms the drinking water standard as per USEPA as well WHO & BIS.

The base operating Capacity of INDION ASM is very high and can treat up to 40,000 BV of 150 ppb Arsenic water with minimal leakage. However, pH and other limiting factors do affect the capacity.

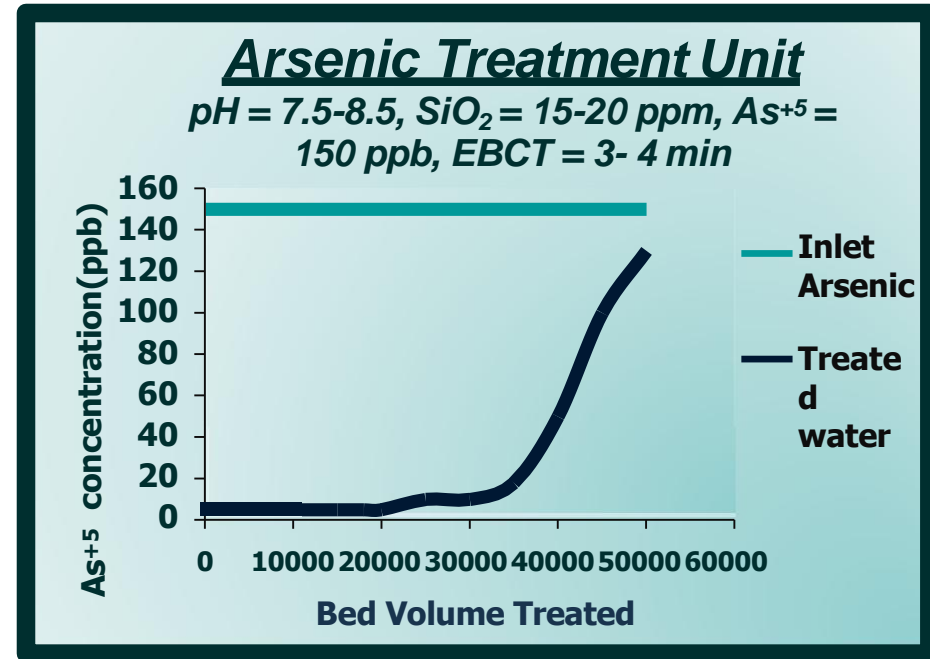

Figure 1 – Results of HPA

Commercial Success – Hand Pump attachments

- Reduces arsenic <10 ppb WHO/BIS limit
- Sturdy & easy to operate
- Works on gravity
- Media replacement is once in a year
- No regeneration/activation is required, simple backwash is sufficient.
- 150-200PE/Day are accessible to pure drinking water

More than 50
units sold across
various states of
India



Arsenic Removal hand pump attachment

Community Based Plant for Arsenic removal- Electricity/Solar operated

- Community based plant can be operated on electricity or Solar
- 4m³/hr Arsenic Removal Plant installed at Bihar, India
- Solar Operated
- Easy to operate
- Considering 6 hours operation , 3000-4000PE/Day are accessible to Pure drinking water



PRETREATMENT REQUIREMENTS

INDION –ASM is a robust media with good mechanical strength and generally requires minimal pretreatment . However, the presence of high levels of suspended solids and biological organic matter may foul the media, resulting in the reduction in capacity and life time of media. Hence we recommend pretreatment with INDION ISR for conversion of arsenite to arsenate and removal of iron and other organic matter.

INDION ASM Pretreatment

- Removal of Organics
- Monitoring pH and removal of suspended solids
- Removal of scale forming compounds



PACKAGING, STORAGE AND SAFETY

INDION ASM is supplied in 50 liters HDPE bags.

Ion exchange medias require proper care at all times. The medias must never be allowed to become dry. Repeated drying and rewetting produce stresses analogous to those due to osmotic shock and can lead to fragmentation of Ion exchangers.

Acid and alkali solutions used for regeneration are corrosive and should be handled in a manner that will prevent eye and skin contact. If any oxidising agents are used, necessary safety precautions should be observed to avoid accidents and damage to the media.



Thank You
www.ionresins.com