

# **HANDBOOK ON WATER AND WASTE WATER TREATMENT**



## FOREWORD

I am pleased to pen this foreword to this handbook which brings out the fundamental concepts on Water and Waste Water Treatment. The handbook covers trouble shooting and maintenance of water and waste water treatment plants. It also provides useful information which will be helpful to everyone associated with water treatment.

During the compilation of this book, we have drawn liberally from both our internal knowledge domain as well as information from various other sources which we gratefully acknowledge. My thanks and appreciation to Mr. N. Ramchandran for compiling this handbook.

I am confident that this handbook will meet the expectations of everyone concerned with water and waste water treatment.

I am happy that this book is being released on the completion of 50 years of Ion Exchange (India) Ltd.

August 2014

**RAJESH SHARMA**  
Chairman & Managing Director



## CONTENTS

CHAPTER	TOPICS	PAGE NO.
<b>1</b>	<b>Introduction</b>	9
<b>2</b>	<b>Water and Waste Water Treatment</b> 2.1 An Overview 2.2 Water Chemistry 2.3 Impurities in Water 2.4 Comparison of Characteristics of Water from Various Sources 2.5 Water Analysis Report 2.6 Contaminants Present in Water and their Harmful Effects 2.7 Unit Concentrations	13
<b>3</b>	<b>Pretreatment of Surface Water</b> 3.1 Introduction 3.2 Aeration 3.3 Pre-chlorination 3.4 Coagulation 3.5 Flocculation 3.6 Clarification 3.7 Filtration	27
<b>4</b>	<b>Pretreatment of Ground Water</b> 4.1 Introduction 4.2 Iron and Manganese 4.3 Fluoride 4.4 Arsenic 4.5 Nitrates 4.6 Removal of Pesticides	51

CHAPTER	TOPICS	PAGE NO.
<b>5</b>	<b>Potable Water Treatment</b> 5.1 Introduction 5.2 Disinfection of water	59
<b>6</b>	<b>Ion Exchange Processes</b> 6.1 Introduction 6.2 Ion Exchange Resins 6.3 Ion Exchange Processes	69
<b>7</b>	<b>Membrane Processes</b> 7.1 An Overview 7.2 Ultra Filtration 7.3 Reverse Osmosis	87
<b>8</b>	<b>High Purity Water Systems</b> 8.1 For Semiconductor Industry 8.2 For Pharmaceutical Industry 8.3 For Power Industry	119
<b>9</b>	<b>Cooling Water Treatment</b> 9.1 Introduction 9.2 Once Through Cooling 9.3 Closed Circuit Cooling Systems 9.4 Open Evaporative Recirculating Cooling Water Systems 9.5 Operational Problems 9.6 Cycles of Concentration 9.7 Recovery of Water from Blowdown	135

CHAPTER	TOPICS	PAGE NO.
10	<b>Boiler Feed Water Treatment</b> 10.1 Introduction 10.2 Classifications of Boilers 10.3 Operational Problems 10.4 Blowdown 10.5 Boiler Feed Water Treatment 10.6 Boiler Water Treatment for High Pressure Boilers 10.7 Condensate Treatment	143
11	<b>Desalting Process</b> 11.1 Introduction 11.2 Multi Stage Flash Distillation 11.3 Multiple Effect Distillation 11.4 Vapour Compression Distillation 11.5 Electro Dialysis 11.6 Electro Dialysis Reversal Process 11.7 Reverse Osmosis	157
12	<b>Waste Water Treatment</b> 12.1 Introduction 12.2 Categories of Effluents 12.3 Heavy Metal Removal 12.4 Process for Removal of Oil (Hydrocarbons) from Industrial Effluent 12.5 Treatment of Sewage 12.6 Anaerobic Processes 12.7 Aerobic Processes 12.8 Some of the Specific Contrasts between Aerobic and Anaerobic Treatment	169

## ANNEXURES

Sr. No.	Title	Page No.
1	Water Analysis Report	195
2	Determination of Bicarbonates, Carbonates and Hydroxides	196
3	Units of Concentration	197
4	Determination of Operating Exchange Capacity	199
5	Guidelines for Troubleshooting and Maintenance of Ion Exchange Units	200
6	Troubleshooting of Ultra Filtration and Reverse Osmosis Units	214
7	Table for Converting to Calcium Carbonate	223
8	Conversion of Common Units	227
9	Conductivity of Solutions at Various Temperatures	228
10	Recommended Maximum Impurity Levels for HCl, NaOH and NaCl	229
11	Typical Analysis for Different Caustic Qualities	230
12	Conversion of Conductivity to Resistance	231
13	Conductivity of Water as Function of Temperature	232
14	Conductance Vs Total Dissolved Solids	233
15	Relationship between Dissolved Solids and Conductance in Demineralisation Operations	234
16	pH of Pure Water as Function of Temperature	235
17	pH of Basic Solutions at 25° C (77° F)	236
18	pH of Acid Solutions at 25° C (77° F)	237
19	Specifications of Filter Media	238
20	Indian Standard Specifications for Drinking Water (IS - 10500)	240

Sr. No.	Title	Page No.
21	World Health Organization Standards for Drinking Water (1993)	241
22	Typical Feed Condensate and Effluent Condensate Analysis of Sub Critical and Super Critical Power Plant	242
23	Stepwise Operation of the Condensate Polishing Plant	246
24	Estimating Water Balance in Cooling Tower	253
25	ASME Guidelines for Industrial Water Tube Boilers upto 900 psi with Super Heater and Turbine Drive	254
26	Procedure for Determination of Silt Density Index	255
27	Solubility Comparison of Hydroxides and Sulphides of Heavy Metals Precipitation	261
28	Permissible Water Quality Standards for Disposal of Treated Waste Water	262
29	Requirements for Water at the Point of Distribution in the Electronics and Semiconductor Industries	264
30	Waste Water Treatment Terms and Definitions	266





# Chapter 01

## INTRODUCTION





## 1.0 INTRODUCTION

Fifty years ago, Ion Exchange (India) Ltd. introduced water treatment technology to India through its parent company The Permutit Co. of UK. Since then Ion Exchange has brought world class technologies to India, thanks to the vision of its founder Mr. G. S. Ranganathan.

In this handbook, we have tried to explain the fundamental concepts of the treatment of water and waste water and are confident that the handbook will meet the expectations of everyone concerned with water and waste water treatment.

Adequate quantity of water and appropriate quality are essential for all human activity - whether drinking, sanitation or industry. Characteristics of water vary depending upon the source. The objective of water treatment therefore is to match the quality of water available at a given place with the requirements for a given application.

The handbook addresses issues relating to industrial applications, as well as treatment of water for human consumption.

A typical water treatment plant consists of the following sections:

- Pretreatment plant: It removes impurities that are likely to affect the performance of downstream units based on ion exchange and/or membrane and thermal processes. Impurities removed include suspended solids turbidity, colour, organic matter and heavy metals like iron and manganese
- Plants based on ion exchange, membrane and thermal processes for softening and partial or complete removal of contaminants present in water
- Post treatment plant: The plant conditions the treated water for the specific end use
- Effluent treatment plant: Industrial effluent requires to be treated before it can be discharged into a public sewer or a receiving stream. Increasing shortage of fresh water is compelling industries to set up plants for recovery of water for reuse in the plant



# Chapter 02

## WATER AND WASTE WATER TREATMENT





## 2.0 WATER AND WASTE WATER TREATMENT

### 2.1 An Overview

Water is used for drinking and sanitation, for industry, agriculture, green belt development and practically every area of human development. Industry uses water for variety of applications - to raise steam to generate power and run machinery, to cool condensers and heat exchangers, in the manufacture of beverages and packaged drinking water, for processing of textiles, in the manufacture of pulp and paper, in production of steel, in pharmaceutical industries and in the manufacture of semi-conductors.

Use of untreated and inadequately treated water results in a number of operational problems like scaling, corrosion and fouling of equipment resulting in unscheduled outages, replacement of expensive equipment and loss of productivity through rejection. The net result is loss of profits.

Water therefore needs to be treated to either modify or remove the impurities and make it suitable for each end use.

Some of the problems relating to water purity are:

- Suspended solids (SS) and turbidity tend to foul ion exchange resins and membranes. In cooling systems they may settle on low velocity areas and result in 'under deposit corrosion'. Presence of SS and turbidity can seriously impair disinfection processes
- Hardness in water forms scales when used in heat exchange equipment. Scales are insulators of heat, affecting heat transfer and causing loss of precious fuel
- Dissolved gases like oxygen and carbon dioxide result in corrosion of heat exchange equipment
- Apart from problems of scaling and corrosion, foulants present in cooling water result in deposits, affecting the flow of cooling water. Deposits in the system can also lead to under deposit corrosion
- High purity water is required in the manufacture of electronic components and in power plants and pharmaceutical industries
- Potable water with low alkalinity is desired in the manufacture of beverages like Pepsi and Coca-Cola
- Soft water is essential in processing of textiles as hard water tends to form precipitates with the processing chemicals and interferes with uniform dispersion of dyes



- Large volumes of soft water are required in the steel industry both for direct and indirect cooling as well as for scrubbing of hot gases released from the furnaces
- Large volumes of treated water are also used in the manufacture of pulp and paper, petroleum refining, and in the petrochemical and fertiliser industries

In short, availability of water of adequate quantity and appropriate quality is vital for industrial growth.

Industry also produces effluent that requires to be treated either for safe disposal or for recovery of water for reuse in the process.

This handbook attempts to address these problems and provide solutions that are both feasible and economical based on 50 years of rich experience and expertise of Ion Exchange. We are confident that the handbook will be useful reference to all those associated with water and waste water treatment.

## 2.2 Water Chemistry

### 2.2.1 Water cycle

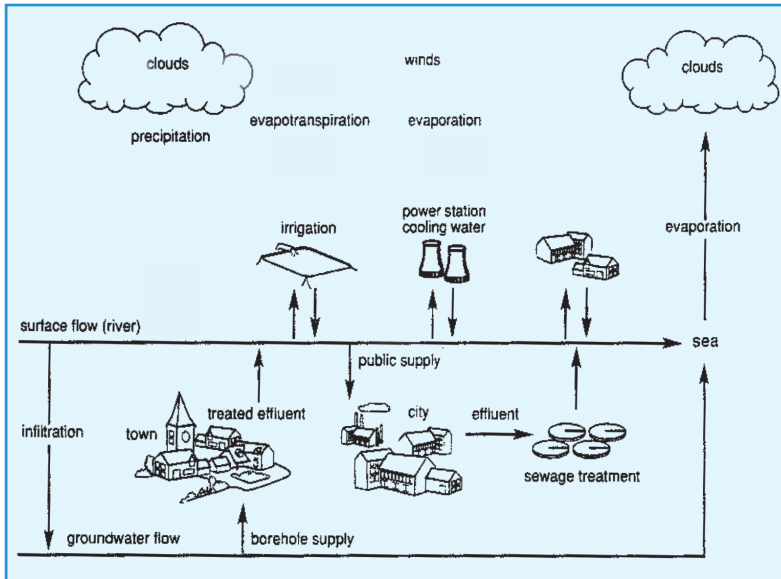

*Fig 2.1 - Typical water cycle*

Shown above is the water cycle familiar to all of us. Water evaporates from the sea, lakes and reservoirs, forms clouds that come down as rain.

Part of the rain water gets collected in lakes and flows through rivers and canals back into the sea.

Part of the water percolates through the soil to form aquifers from where water is drawn through bore wells for various purposes.

Treated industrial effluents and sewage are discharged into public sewers and receiving streams.

### 2.2.2 Sources of water

Water for industries is drawn from one or more of the following sources:

- Surface water - rivers, canals, lakes and the sea (in coastal areas)
- Ground water – bore wells, ranney wells and artesian wells
- Municipal supply - treated water of potable quality supplied by municipalities
- Water recovered from industrial effluent and municipal sewage

Depleting sources of fresh water, pollution of our rivers and ground water, and increasing cost of fresh water are forcing industries to explore the possibility of recovering water from industrial effluent and municipal sewage.

## 2.3 Impurities in Water

Impurities in water fall into two broad categories:

- Undissolved impurities
- Dissolved impurities

### 2.3.1 Undissolved impurities include the following:

- Suspended solids - floating and easily settleable particles
- Colloidal particles - very fine particles of clay, sand, etc. that do not readily settle and cause haziness or turbidity in water
- Organic matter of vegetable or animal origin and microorganisms

**2.3.2 Dissolved impurities include the following:**

- Mineral salts
- Organic matter (humic & fulvic acids)
- Detergents, ligno sulphonates & organo-phosphates from industrial pollution
- Pesticides & herbicides (from agricultural run off) and
- Dissolved gases

**2.3.3 General characteristics of surface and ground water**

Water from rivers, canals and lakes are low in dissolved solids but high in suspended solids, turbidity and organic matter especially during the monsoons. Water stored in lakes and reservoirs is likely to have moderate to high levels of biotic components. Surface water is also susceptible to pollution from industrial/domestic effluent.

Characteristics of sea water are similar to those of surface water, except that it is very high in salinity, marine growth and organisms.

Ground water is relatively free from suspended solids and colloidal particles and is low in organic matter and industrial/domestic pollution but is likely to be high in dissolved solids.

Ground water in areas like Assam, West Bengal and other north eastern states of India may contain high levels of iron and/or manganese. Water containing iron and manganese is relatively clear when drawn but turn turbid due to oxidation of iron and/or manganese.

Fluoride is present in some parts of India including Rajasthan, the Deccan Plateau, Madhya Pradesh and Gujarat. Arsenic is present in West Bengal and Bangladesh.

Water supplied through municipal corporations is generally drawn from surface water sources and is clarified, filtered and chlorinated before supply. In most cities the pipelines are fairly old and run close to sewer lines and run the risk of getting re-contaminated due to leakages before it reaches the end user.

**2.4. Comparison of Characteristics of Water from Various Sources**

Parameter	Surface Water	Ground Water	Sea Water
Temperature	Variable	Constant	Variable
Suspended solids	Low – High	Absent	Low – High
Turbidity	Low – High	Very low	Low
Organic matter	Low – High	Very low	Low – High
Dissolved oxygen	Near saturation	Nearly absent	Near saturation
Salinity	Low – Medium	Medium – High	Very high

## 2.5 Water Analysis Report

A water analysis report provides useful information on the mineral and biological impurities present in water at a given location. It forms the basis for design of water treatment plants. Format for a typical water analysis report is given in Annexure-1.

## 2.6 Contaminants Present in Water and Their Harmful Effects

### 2.6.1 Colour

Colour in water may indicate the presence of iron, manganese or organic matter. Iron salts turn water to brown/red; manganese salts make it black and organic compounds may colour it yellow.

Colour in waste water may be due to presence of metallic compounds, organic waste from sugar, paper mills or dyes and dye intermediates.

Presence of colour in water is undesirable from an aesthetic point of view. Water used for processing of textiles and in the manufacture of pulp and paper must be free of colour. Water used for drinking and in production of beverages should be absolutely free of colour.

Colour is expressed in APHA (Pt-Co or in Hazen units). The units are interchangeable.

Heavy metals like iron and manganese are removed by oxidation followed by clarification and/or filtration. Colour due to the presence of organic compounds is removed either by oxidation or with organic scavenger resins.

### 2.6.2 Odour and taste

These are indicators of the presence of undesirable impurities such as hydrogen sulphide or sewage contamination and are important parameters for water quality control in the food and beverage industries.

Surface water sources can become contaminated by algal bloom and from discharge of untreated industrial wastes or domestic sewage resulting in the release of taste and odour causing chemicals into the water.

Ground water supplies may get contaminated with dissolved minerals, such as iron and manganese and emit objectionable odour and taste. Taste and odour causing compounds can also enter into the raw water transmission system or into the treatment plant through algal growths, accumulated debris and sludge, or disinfection by-products.

The two methods used for these tests - the Threshold Odour Test and the Flavour Profile Analysis - are subjective tests since both depend on human perception of the taste and odour in the water.

Odour can be removed by aeration, oxidation and treatment with activated carbon.

### 2.6.3 Suspended solids

The term suspended solids (SS) refers to particles that float or settle rapidly when the sample of water is allowed to stand for some time.

Suspended solids tend to foul ion exchange resins and reverse osmosis membranes. They tend to settle in low flow areas in heat exchange equipment and may cause under deposit corrosion. Suspended solids are removed during the processes of clarification and filtration.

Suspended solids in water samples are determined by pouring a carefully measured volume of water (typically one litre) through a pre-weighed filter of a specified pore size and then weighing the filter again after drying, to remove all water.

Filters for SS measurements are typically composed of 0.4 micron filter or glass fibres. The gain in weight is a dry weight measure of the particulates present in the water sample expressed in units derived or calculated from the volume of water filtered (typically milligrams per litre or mg/l).

Suspended solids are removed by filtration through granular media or micron cartridge filters. They are also removed by filtration through membranes.

### 2.6.4 Turbidity

Turbidity in water is due to the presence of finely divided particles of sand, clay or dust of colloidal dimensions and result in haziness of water. Measurement of turbidity is a key test of water quality.

Colloidal particles foul ion exchange resins. Reverse osmosis membranes in spiral wound configuration are fouled irreversibly.

The most widely used units for measurement of turbidity are the FTU (Formazin Turbidity Unit) or the NTU (Nephelometric Turbidity Unit).

Turbidity in water is measured using a turbidity metre. A ray of light is passed through the sample of water; the light scattered by the sample of water at 90° C to the incident ray is measured and compared with that of a standard formazine solution. The value is reported as NTU.

Turbidity in water is removed by coagulation, flocculation and clarification followed by filtration. It can also be removed by micro filtration and ultra filtration membranes.

### 2.6.5 pH

pH is defined as the negative logarithm of hydrogen ion concentration.

$\text{pH} = -\log [\text{H}^+]$  where  $[\text{H}^+]$  = concentration of hydrogen ion mol/l

pH of pure water is 7. The pH scale ranges from 0 - 14 with 7 as the neutral point.

pH below 7 represents an acidic medium and pH above 7 indicates an alkaline medium.

pH is measured using a pH electrode that consists of a reference electrode and the measuring electrode. Measuring pH of low conductivity water requires special consideration.

pH can also be qualitatively measured by using pH indicators and pH papers. pH plays an important role in almost all water and waste water processes.

### 2.6.6 Alkalinity

Alkalinity in water is due to the presence of alkaline salts and is the sum of bicarbonates, carbonates and hydroxides in water.

Alkalinity needs to be controlled both in boiler water and in cooling water. Concentrates used in the manufacture of beverages like Pepsi and Coke are acidic. Highly alkaline water neutralises the acidity of the concentrate and the drink loses its “tang”.

Alkalinity can be destroyed by addition of an acid (for example sulphuric acid). Alkalinity can also be removed by the dealkalisation process using a weak acid cation resin. The strong acid cation resin used in the demineralising plant removes it completely.

Alkalinity in water is determined using two indicators - Phenolphthalein and Methyl Orange. Phenolphthalein indicator gives P-Alkalinity or P-value contributed by carbonates and hydroxides and methyl orange indicator gives the M-Alkalinity or M-value or Total Alkalinity and includes bicarbonates, carbonates and hydroxides.

The quantity of bicarbonate, carbonate and hydroxide present in water are determined from the P-value and M-value by the alkalinity relationship.

The procedure for determining values for P-Alkalinity and M-Alkalinity is given in Annexure-2. Based on these two values, bicarbonates, carbonates and hydroxide can be determined using the table.

### 2.6.7 Equivalent mineral acidity (EMA)

The term EMA represents the sum of chlorides, sulphates, nitrates fluorides present in water. When a sample of water is passed through a column of strongly acidic cation exchange resin in H<sup>+</sup> form, the neutral salts are converted into corresponding mineral acids (e.g HCL, H<sub>2</sub>SO<sub>4</sub> and HNO<sub>3</sub>) present in quantity equivalent to that present in feed water and hence the name EMA.

By titrating the resultant solution from above said column, against a standard alkali solution one can arrive at EMA. This method eliminates any possible error involved in estimating sulphates gravimetrically.

### **2.6.8 Total hardness (TH)**

Hardness in water is due to the presence of calcium and magnesium salts. Hardness is not desirable as it forms scales in geysers, boilers and other heat exchange equipment. Hardness also has to be removed for processing of textiles.

The process of removing hardness is called softening. Hardness can be removed either by the lime soda process or by the ion exchange process using a strong acid cation exchange resin in sodium form.

Hardness present in highly saline water can be removed using a weak acid cation exchanger in sodium form.

A part of the total hardness is associated with alkalinity in water and is referred to as alkaline, carbonate or simply temporary hardness and the balance is associated with the equivalent mineral acidity (EMA) of water and is called non-alkaline, non-carbonate or permanent hardness.

For example, if water contains, say, 200 mg/l hardness and 200 mg/l alkalinity then all the hardness is present as bicarbonate or temporary hardness. If it contains say, 200 mg/l hardness and 250 mg/l alkalinity then water contains 200 mg/l temporary hardness and 50 mg/l of sodium alkalinity. If 250 mg/l hardness and 200 mg/l alkalinity are present, then water contains 200 mg/l temporary hardness and 50 mg/l permanent hardness.

### **2.6.9 Silica**

Silica is present in water as soluble hydrated silica ( $\text{SiO}_2 \cdot \text{H}_2\text{O}$  and  $\text{SiO}_2 \cdot 2\text{H}_2\text{O}$ ). It is also called reactive silica as it readily forms the typical yellow colour when a solution of ammonium molybdate is added to the sample of water.

It is so weakly dissociated that we do not consider it while matching the cations with the anions present in water. However, a strong base anion resin removes silica due to its high basicity and it is taken into account while computing the ionic load on the strong base resin.

Silica is also present in surface water as un-dissociated polymer (called non-reactive or colloidal silica). This is not removed in the demineralising plant but gets converted into reactive silica in the boiler drum of high pressure boilers. Silica content in the boiler drum increases, resulting in

increased blowdown to keep the drum silica within the limits prescribed by the boiler manufacturers.

Increased blowdown results in loss of precious condensate and hence fuel loss. The higher the calorific value of the fuel used, higher is the loss of revenue. Removal of both forms of silica is therefore essential for high pressure boilers.

Colloidal silica can be removed only partially by conventional methods of coagulation and clarification as it is not a pure colloid. It is contaminated with hydrated oxides of iron (Fe) and aluminium (Al), and organic matter found in soil and is referred to as 'Universal Colloid'. Membrane processes like ultra filtration and reverse osmosis can remove colloidal silica almost completely.

Ultra filtration is currently recognised as the most effective way of removing colloidal silica.

Reactive silica is estimated by the addition of ammonium molybdate when a yellow colour is formed. On addition of a reducing agent like sodium sulphite, a blue colour is formed and the intensity of the colour is measured using a standard colour disc or a spectrophotometer. Online silica analysers provide an accurate indication and record of reactive silica present in water.

Colloidal or non-reactive silica is present only in surface water and in very small quantities in ppb levels. It is normally present during the onset of the monsoons or immediately thereafter. Water stored in lakes and reservoirs may however contain colloidal silica throughout the year.

Estimating the amount of colloidal silica in raw water is often difficult and involves a laborious procedure and the use of hazardous chemicals like hydrofluoric acid. Almost all methods involve a weighing step and can result in errors as colloidal silica is present in ppb levels. An accurate method is to back calculate from boiler drum silica values and the blowdown.

#### **2.6.10 Total dissolved solids (TDS)**

TDS refers to concentration of dissolved solids in water, in ppm or mg/l and is due to all charged ions - cations and anions, as well as uncharged and molecular species.

It is estimated by evaporating a known sample of water to 110° C and estimating the weight residue. It is expressed as mg/l. TDS needs to be reduced or removed completely for most of the applications like boiler feed and cooling water systems.



TDS is one of the parameters that control the blowdown for low and medium pressure boilers. For high pressure boilers TDS needs to be removed almost completely.

Dissolved solids can be removed either by demineralisation, reverse osmosis or by thermal processes.

### **2.6.11 Electrical conductivity**

Conductivity of water is a measure of dissolved minerals/salts and is thus a true indicator of the purity of water. It is measured by passing an alternating current through a conductivity cell containing two square electrodes, each with an area of 1 sq. cm. and placed 1 cm apart. The resistance offered by the volume of water in the cell is measured using a wheatstone bridge.

Conductivity is the reciprocal of resistivity. Conductivity is expressed as micro Siemen per cm while resistivity is expressed as megaohm.

Conductivity varies with temperature - the higher the temperature the higher is the conductivity.

It is often difficult to determine the TDS of demineralised or desalted water by gravimetric method of evaporating the water sample to dryness, as the residue left on evaporation is too small to weigh by normal balance.

It can however be determined by the conductivity of the water sample. For example each mg/l of a neutral salt exhibits a conductivity of 2  $\mu\text{S}/\text{cm}$  @ 25° C.

Conductivity of dematerialised water from a two-bed unit will be in the region of 5-10  $\mu\text{S}/\text{cm}$  @ 25° C. A mixed polisher produces water with a conductivity of 0.1-0.2  $\mu\text{S}/\text{cm}$  @ 25° C. Purest water has a conductivity of 0.055  $\mu\text{S}/\text{cm}$  @ 25° C.

### **2.6.12 Organic Matter**

Surface waters contain organic matter of vegetable or animal origin. As rivers flow through forests they pick up high molecular weight organic matter (collectively called humic and fulvic acids) from decaying leaves, twigs, bark, etc.

Organic matter carries a negative charge and is adsorbed by strong base anion exchange resins in demineralising plants. But it is not eluted during regeneration resulting in organic fouling. During regeneration, it is converted into sodium salt of the organic acids. During subsequent

rinse, it gets hydrolysed and releases caustic soda. This results in an increase in pH and conductivity and long rinse requirements.

Organic matter should preferably be removed in pretreatment of water by oxidation with chlorine or any other oxidant. Strong base resins resistant to organic fouling should be used. Should the resins get fouled, alkaline brine treatment (treating the unit with a 10% NaCl and 1% NaOH) should be carried out at regular intervals.

Organic matter present in water may be expressed in one of the following ways:

Permanganate Value (Oxygen Absorbed, OA value) includes matter oxidised by acidified potassium permanganate for 4 hours at 27° C and is expressed as mg/l  $\text{KMnO}_4$ .

Chemical Oxygen Demand (COD) indicates organic matter oxidised by hot acidified potassium dichromate. It covers the majority of organic compounds and oxidisable mineral salts.

Biochemical Oxygen Demand (BOD) represents the amount of oxygen used by microorganisms to consume biodegradable organics in waste water under aerobic conditions. Generally the sample is incubated for 5 days and the result reported as  $\text{BOD}_5$ .

Total Organic Carbon (TOC) indicates the content of carbon linked to organic material by measuring the carbon dioxide after complete oxidation. A quick method is to test the total organic matter content of water sample.

TOC, COD and BOD are terms generally used in water and waste water treatment.

## 2.7 Unit Concentrations are described in Annexure - 3.



# Chapter 03

## PRETREATMENT OF SURFACE WATER

**Cascade aeration  
at a power plant**



**Clarifiers section  
at a paper plant**



**Pretreatment for a fibre  
manufacturing plant**



**Continuous sand filter for  
surface water treatment**





## 3.0 PRETREATMENT OF SURFACE WATER

### 3.1 Introduction

Surface water includes rivers, canals, lakes and reservoirs. It is characterised by moderate to high levels of suspended solids, turbidity, organic matter, algae and other microorganisms but is low in dissolved solids. Industries like power plants, refineries and pulp & paper mills require large volumes of water and are generally always located close to surface water sources. Industries located in coastal areas use sea water for cooling and desalinated water for other uses like boiler feed, drinking and sanitation etc.

Almost all processes require softening, partial or complete removal of contaminants present in the water. This is usually achieved through processes based on ion exchange, reverse osmosis or thermal desalination.

Pretreatment of surface water is essential to remove all impurities that are likely to affect the performance of downstream plants designed for removal of dissolved solids.

The main stages of pretreatment are:

- Aeration
- Pre-chlorination
- Coagulation
- Flocculation
- Clarification
- Granular media filtration and
- Filtration by activated carbon

### 3.2 Aeration

Aeration is the first step in pretreatment of surface water. During this process raw water cascades down a stepped fountain resulting in large contact area between air and water. This helps in oxidation of heavy metals, if any, with simultaneous release of carbon dioxide and other odours.

A cascade aerator built of concrete is the most common equipment. Water is allowed to flow upward through the inner pipe and cascade down through each tray.

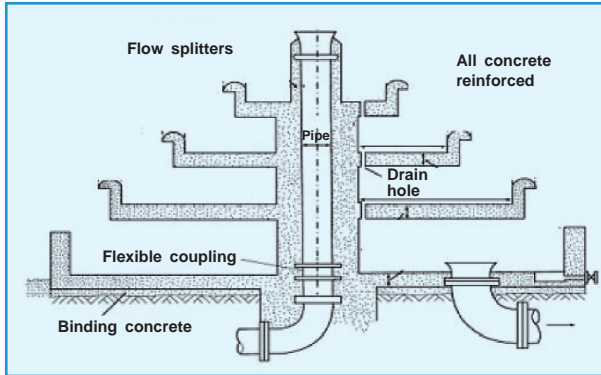
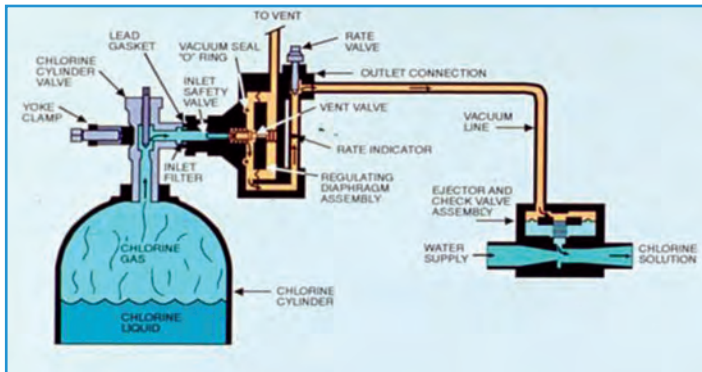

*Fig 3.1 - Typical cascade aerator in concrete fitted with incoming inlet and outlet pipes and trays.*

### 3.3 Pre-chlorination

Pre-chlorination is normally carried out at the raw water intake point. The objective of chlorinating the water is primarily to oxidise organic matter and prevent microbial growth in the pipeline from the intake point to the storage reservoir. Up to 2 mg/l of continuous chlorination is the normal practice.

Chlorination is carried out using a gas chlorinator which dissolves chlorine in water. Gas chlorination is best suited for large volumes of flow. For smaller systems a solution of sodium hypochlorite (NaOCl) can also be used. Yet another alternative is the use of chlorine dioxide in place of chlorine.



*Fig 3.2 - Typical assembly consisting of a chlorine cylinder and hydraulic ejector assembly for supply of chlorine solution.*

When chlorine gas is dissolved in water, a mixture of acids - hypochlorous and hydrochloric, are formed. Hypochlorous acid is a powerful oxidant. It oxidises organic matter and kills bacteria.

Chlorine is effective in a narrow range of pH (6.5 to 7.0). At higher pH it forms hypochlorite ion which is not as effective as hypochlorous acid. To be effective, both dosage and contact time are important.

Equipment for addition of hypochlorite consists of a solution preparation cum dosing tank and an electronic metreing pump.

Free residual chlorine of 0.1 mg/l ensures complete oxidation of organic matter and absence of pathogenic bacteria.

### 3.4 Coagulation

Coagulation, flocculation and clarification are the unit processes employed for the removal of colloidal particles. Colloidal particles are finely divided particles of sand, clay or algae and cause haziness or turbidity in water. While most particles, given sufficient time, will settle on their own, colloidal particles do not settle.

Colloidal particles carry a negative surface charge due to which they repel each other and do not coalesce to form particles large enough to settle readily.

Addition of a coagulant like alum neutralises the surface charge allowing the particles to coalesce with one another and become larger particles. In addition, the precipitate formed by alum is fluffy in nature and this helps in adsorbing the fine particles.

The process is pH sensitive and works best in a narrow range of 6 - 7.5. Addition of alum results in a decrease in alkalinity and an increase in sulphate.

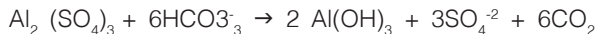

The equipment used for coagulation is a flash mixer fitted with a high speed mixer. It helps increase the number of collisions between the coagulant and the colloidal particles, resulting in the formation of flocs. The retention time in the flash mixer is typically 1 - 2 minutes.

A number of coagulants are in common use in water treatment. These include alum, ferric chloride, ferric sulphate, ferrous sulphate, sodium aluminate and poly aluminum chloride.

The addition of a coagulant results in a small change in the water composition. For example, addition of each ppm of alum decreases alkalinity of the water by 0.45 mg/l and increases sulphate by the same amount.



The feed water composition needs to be modified to reflect this change due to addition of the coagulant.

The requirements for effective coagulation include optimal pH, availability of sufficient alkalinity in water, choice of coagulant, retention time and high speed agitation.

Some waters are low in alkalinity and, in such cases, addition of an alkali like sodium carbonate, caustic soda or lime may be required.

### 3.5 Flocculation

Flocculation is the next step after coagulation.

The term flocculation refers to the process of agglomeration of flocs and this is aided by the addition of a polyelectrolyte (coagulant aid). Polyelectrolytes are long chain polymeric compounds and the flocs get attached to them. Addition of a flocculant may not be required in all cases but its addition will help in formation of larger and heavier flocs.

The equipment used is a flocculator fitted with a slow speed mixer or a set of slowly moving paddles, providing a gentle motion that promotes the growth of the flocs in size and weight. The flocculator forms an integral part of clarifier designs.

Polyelectrolytes are cationic, anionic or non-ionic and the choice will depend on the application. In normal water treatment applications cationic polyelectrolytes are widely used.

The selection of the coagulant and flocculant and their dosage, and the determination of optimal pH required for effective removal of turbidity are done by using a jar test apparatus in the laboratory.

The apparatus consists of 4 - 6 glass jars and is fitted with motorised mixers with adjustable speed drives. Dosages of coagulant and flocculant are varied and the nature of flocs formed is observed. Flocs formed must be larger in size and readily settling.

Shown is a jar test apparatus with four jars and fitted with individual mixers.

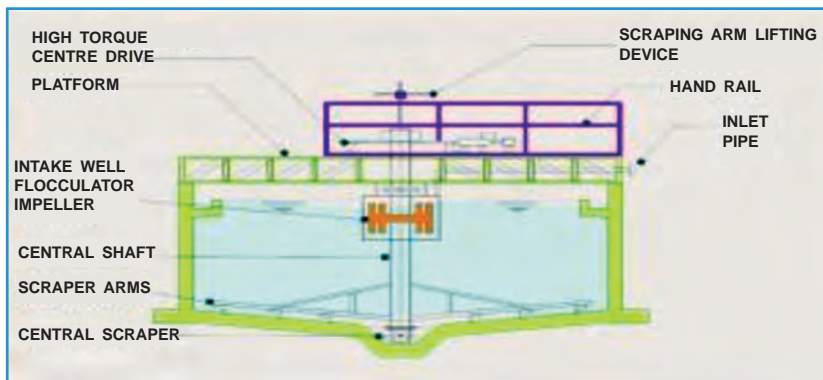

*Fig 3.3 - Jar test apparatus*

### 3.6 Clarification

The next step following coagulation and flocculation is clarification or settling which takes place in an equipment called clarifier. Although a number of variations exist, the most commonly used clarifiers are clariflocculator, high rate solids contact clarifier, lamella clarifier, sludge blanket clarifier, pulsator clarifier and the actiflo clarifier.

#### 3.6.1 Clariflocculator



*Fig 3.4 - General arrangement of clariflocculator*

The clariflocculator is a circular clarifier with an integral flocculator compartment. The coagulant is added into the flash mixer, external to the clarifier. Coagulated water enters through the inlet pipe into the flocculating compartment fitted with slowly moving paddles that provide a gentle agitation to promote the growth of flocs. A flocculant is normally added in the flocculator compartment.

Water containing the flocs goes down in the flocculator and rises upwards in the clarifier compartment when the flocs settle down. Clear water rises upwards and is collected through the radially located launders and flows into a clarified water reservoir. The clariflocculator is fitted with a sloping bottom and a central scraper.

The scraper assembly allows the sludge to move downwards to the bottom sludge collection cone at the centre, to be removed at periodic intervals. A telescopic arrangement is provided for periodic withdrawal of sludge.

### 3.6.2 High rate solids contact clarifier (HRSCC)

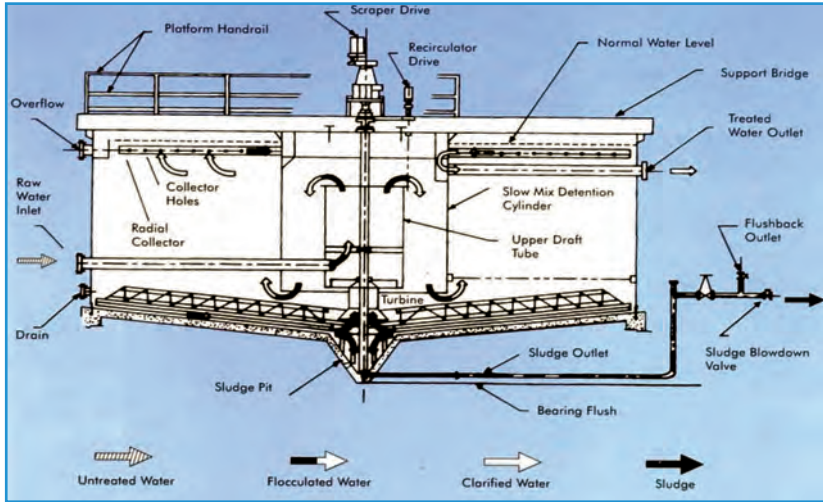

*Fig 3.5 – Cross section drawing of HRSCC*

The HRSCC is circular in shape and is fitted with a draft tube at the center, a flocculation chamber and a clarification zone. The HRSCC has two drives - a high speed turbine drive fitted in the draft tube and a scraper drive fitted in the clarification zone.

The HRSCC can handle large variations in flow and suspended solids and produce water with high clarity.

Raw water coagulated with a coagulant enters the HRSCC through the inlet pipe located closer to the bottom of the clarifier. Unlike other clarifiers, there is no need for a separate flash mixer.

A high speed turbine drive fitted in the draft tube sucks in the previously formed flocs from the bottom and allows them to mix rapidly with the incoming water which is already coagulated, resulting in increased number of collisions between the coagulant and the colloidal particles.

A flocculant is added into the draft tube and the water flows out into the flocculating compartment and rises upwards in the clarification zone, allowing particles to settle down. Clear water is collected in the radial collectors and flows out by gravity into the clarified water reservoir.

## Features and advantages

Features	Advantages
Energy efficient design	Low power consumption
Intimate and prolonged contact with large quantities of previously formed flocs	Rapid chemical reactions
	More complete reactions
	15-20 % reduction of chemicals required
	Thorough contact with solids regardless of throughput
	Minimum possibility of carryover
	Minimum amount of water lost by blow-off
	Reduced dewatering requirements
Entire bottom used for settling and collection of dense floc precipitate	Dense, easily settled precipitates
In-built flash mixer, flocculator and thickener	Low capital cost - space saving, compact, easy operation
In-built thickening pickets concentrate the settled sludge	Minimises dewatering cost of downstream equipment
Tangential water inlet	Greatly increases re-circulator efficiency
Slowly moving multi blade scraper carry settled flocs into the sludge	More complete reactions
	Minimum amount of water lost by blow-off
	High sludge consistency
Mechanisms are suspended from fixed bridge	Minimum operator attention required
	Simplifies maintenance
Flash mixing and slow speed agitation require low retention time	Rapid chemical reactions
Simple to operate	Lowest effluent turbidity
	Minimum operator attention required
Circulation flows can be varied to suit different loads	Provides greater flexibility

## Applications

Clarification of surface water, lime soda softening, colour removal, white water recycling, primary (physico-chemical) treatment of waste water and removal of heavy metals in the chemical and automobile industries.

### 3.6.3 Ultra high rate solids contact clarifier (UHRSCC)

The ultra high rate solids contact clarifier (UHRSCC) is a compact, efficient and low cost clarifier for clarification of surface water and waste water. The UHRSCC design combines the technologies of the high rate solids contact clarifier and the lamella clarifier, offering the advantages of both, with enhanced performance at increased rise rate.

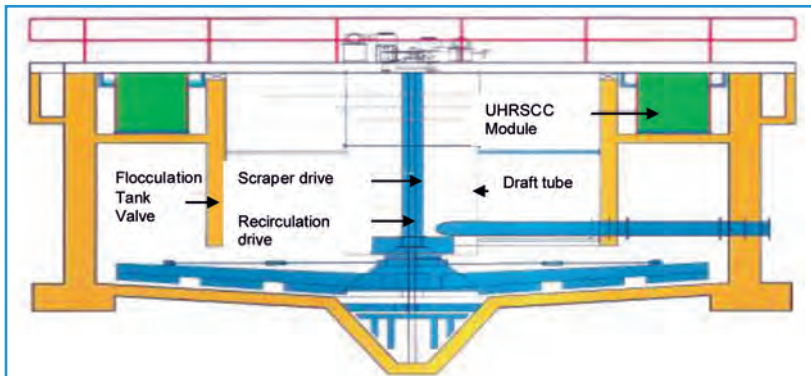

*Fig 3.6 – Cross section drawing of UHRSCC*

The UHRSCC unit is a true solids contact clarifier that combines mixing, flocculation and sedimentation in a single basin. Raw water and chemicals mix with previously formed sludge and then pass through distinct zones within the basin for reaction, flocculation, separation, sludge removal and clarification. All occur in a single treatment basin for maximum treated water production in minimal space, making the UHRSCC the best choice among solids contact clarifiers.

Features	Advantages
Combined technology of solid contact clarifier and inclined plate clarifier	Improved performance at very high flow rates
Reactions, flocculation, separation, sludge removal and clarification occur in a single treatment basin	Minimal space requirement
Intimate and prolonged contact with large quantities of previously formed solids	Rapid chemical reaction
	Complete chemical reaction
	Dense, easily settled precipitates
	Minimal chemical requirement

Features	Advantages
Positive uniform recirculation of solids independent of feed flow	Thorough contact with solids Sudden flow fluctuation does not affect performance Uniform results obtained regardless of feed suspended solid fluctuation Minimum energy consumed
Lamella plates in clarification zone	Utilisation of complete area Handles higher flow rate Reduces the overall size of equipment and hence the cost Better outlet quality
Entire bottom of UHRSCC unit is used for settling and collection of dense precipitates	Effective solid handling and sludge removal Maximum consistency of sludge
Thickening pickets concentrate the settled sludge, which is then removed as highly concentrated slurry	Minimum amount of water lost through sludge blowdown Maximum solids concentration for subsequent dewatering

### Applications

- Clarification of surface water
- Lime soda softening
- Removal of colloidal silica
- Colour removal
- Removal of iron and manganese

#### 3.6.4 Lamella (or plate type) clarifier

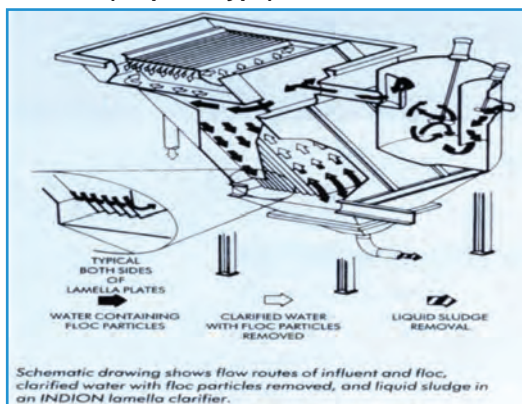

Fig 3.7 - Cross section drawing of lamella clarifier

The clarifier makes use of plates inclined at 55° to the horizontal for settling of solids. The settling area provided is equal to the sum of the projected area of each plate. The compact design ensures that the footprint for the clarifier is less than one-tenth of a normal clarifier. Settling area available is less. The plates can be cleaned in situ.

Raw water enters the flash mixer fitted with a high speed mixer where the coagulant is added. It then moves to the flocculation zone fitted with a slow speed mixer. Water moves through the inlet distributor fitted with throttling orifices. Feed ducts distribute the water through both the sides.

As the water rises above the plates, settled solids roll down the plates and are allowed to accumulate in the sludge collector at the bottom. Clear water flows out through the outlet orifices.

As the lamella plates are normally spaced approximately 50 mm apart, large settling surfaces are concentrated within a relatively small floor area. The clarifier works best with high turbidity water. In case of low turbidity water, sludge collected from the bottom needs to be recirculated.

The design ensures laminar, stable flow and produces clarified water of excellent quality.

The design features include dual flow entry, gravity sludge removal and absence of moving parts. It is compact (requires 1/10th the space of a conventional clarifier).

The construction features include variable plate configuration, ease of installation, lower footprint, variable configuration of bottom hopper and it is a single packaged unit with minimum civil work.

Plates can be cleaned one by one even when the unit is in operation. There are no moving parts and hence needs very little maintenance.

#### **Advantages over clariflocculators**

- The unit requires less floor space
- The unit requires little civil works and less time for construction
- Is capable of capacity expansion
- Ease of operation
- Plate configuration can be varied to suit applications
- Plates can be cleaned while the unit is in operation

### Advantages over tube settlers

Lamella clarifiers can handle higher loads. On-line cleaning is possible whereas even off-line cleaning is troublesome in tube settlers. Settling area is much less than that in a tube settler which requires larger space/ increased size/more tubes. Water entry from the side as against the bottom - minimum distribution and entry velocities optimise hydraulic flow regime - full plate utilisation, maximum efficiency and better effluent quantity. Consistency assured unlike distributed flow through the chamber in the tube settler.

### Applications

Applications include clarification of water, ash/scrubber waste treatment, brine clarification, separation of coal and other minerals, filter backwash water recovery, food & dairy processing and waste treatment, iron removal, metal hydroxides separation, mill scale separation, municipal water and waste treatment, phosphorus acid waste treatment, plating and finishing waste treatment, semi-conductor process water treatment and white water pulp & paper treatment.

#### 3.6.5 Sludge blanket clarifier

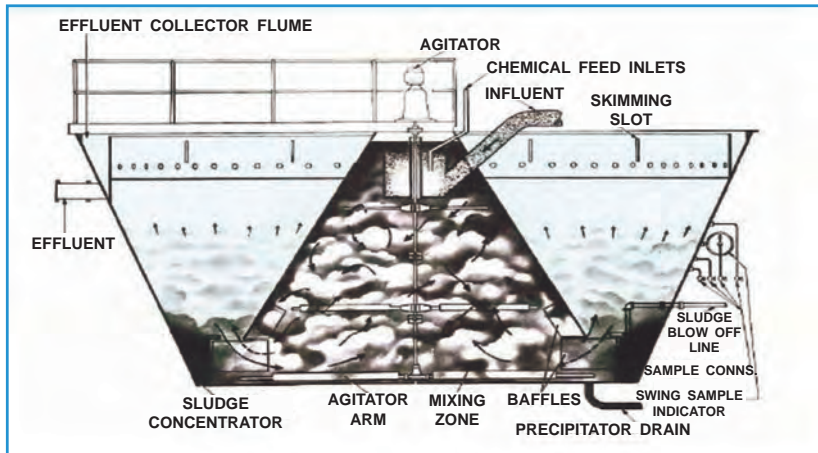

*Fig 3.8 – Cross section drawing of sludge blanket clarifier*

Sludge blanket clarifiers depend on the filtering action of the sludge blanket as the freshly coagulated or flocculated water passes through the suspended flocs. Higher sludge levels increase the filtration efficiency. In practice, the top sludge interface is carried at the highest safe level to prevent upsets that might result in large amounts of floc carryover into the overflow.



Excessive sludge withdrawal or blowdown should also be avoided. The sludge blanket level is often highly sensitive to changes in throughput, coagulant addition, raw water chemistry and temperature.

Because the centre well in these units is often shaped like an inverted cone, the rise rate of the water decreases as it rises through the steadily enlarging cross section. When the rise rate decreases enough to equal the settling rate of the suspended floc, a distinct sludge/liquid interface forms.

### **Applications**

Applications include turbidity removal, lime/lime soda softening, silica removal, iron and manganese removal and waste treatment.

### **Advantages**

Advantages include excellent clarity of treated water, compact design, effective utilisation of detention period, reduced waste water because controlled sludge blow-off reduces waste water and low turbidity of treated water which minimises filter load.

## **3.7 Filtration**

### **3.7.1 An overview**

Filtration is the last step in pretreatment of surface water. Fine or coarse sand, anthracite, garnet and granular activated carbon are used as the filter media.

Filters are grouped into pressure filters and gravity filters based on whether water to be filtered flows under pressure through the filter or by gravity.

Based on the media used for filtration, filters are classified into single media, dual media or multi media filters. Fine riverbed quality sand (16/32 BSS), granular anthracite or activated carbon is used as the filter media in single media filters. Dual media filters use both anthracite and sand as filter media. Multi media filters use sand, anthracite and garnet as filter media.

Multi grade filters use a mix of coarse and fine sand as the filter media and are used as depth filters.

Micron cartridge filters are used to protect membrane elements from getting fouled by colloidal particles. A number of vertical PP wound or spun cartridges are assembled in a housing. Filters of different

ratings are available in the market place. A 10 micron (nominal rating) cartridge filter for example will remove upto 80% of particles greater than 10 microns. A similar cartridge with an absolute rating of 10 microns will remove all particles above 10 micron.

Special filters used in oil fields use nutshell (crushed walnut) for removal of suspended solids and traces of oil present in water. Oil coalescers used for removal of traces of oil (hydrocarbons) from condensate use an ion exchange resin treated with a surfactant for incorporating oleophilic properties.

Desalination of sea water by thermal processes produces water with practically no solids and, to make it potable, it is treated through a 'calcite' filter. The filter media is essentially calcium carbonate which gets added on to water improving its alkalinity and Ca imparting taste to the water.

Almost all granular media filters are designed as "dead end", filters meaning that the flow of water to be filtered is perpendicular to the filter media. These operate as batch filters. As filtration proceeds, dirt starts accumulating on top of the media. The resultant pressure drop reduces the flow and the filter needs to be taken out of service for backwashing.

Continuous sand filters developed specifically for mill scale filtration in the steel industry, however operate on a continuous basis as the filter has an inbuilt sand washer that removes the dirt on a continuous basis enabling the filter to be run continuously.

### **3.7.2 Membrane filtration**

Membrane filtration involves the use of semi permeable membranes that selectively allow dissolved molecules to permeate through and reject the undissolved impurities. Examples are micro filtration and ultra filtration. They are continuous filters. Water to be filtered flows tangentially across the membrane surface. The feed flow is divided into two streams - filtered water appears as the permeate stream and the stream containing the undissolved components as the reject stream. These are more expensive as compared to conventional filters but the advantage stems from the fact that they do not require any chemical treatment. A more complete discussion follows in the section titled 'Membrane Processes'.

### **3.7.3 Pressure sand filter**

In the pressure sand filter, raw water flows under pressure downwards through the filter bed. The suspended matter - which has usually been treated by addition of a coagulant like alum, is retained on the sand surface and between the sand grains immediately below the surface,

Water to be filtered is admitted into the filter through an inlet distributor, passes through the filter media and is collected by a treated water collection system.

As filtration proceeds, pressure drop across the filter increases and the flow drops. Once the pressure drop exceeds the set limit, the filter is taken out for backwash. It is backwashed with filtered water by reversal of flow. Air scouring prior to backwash helps in preventing the filter media from becoming mudballs.

### 3.7.3.1 Vertical pressure sand filter

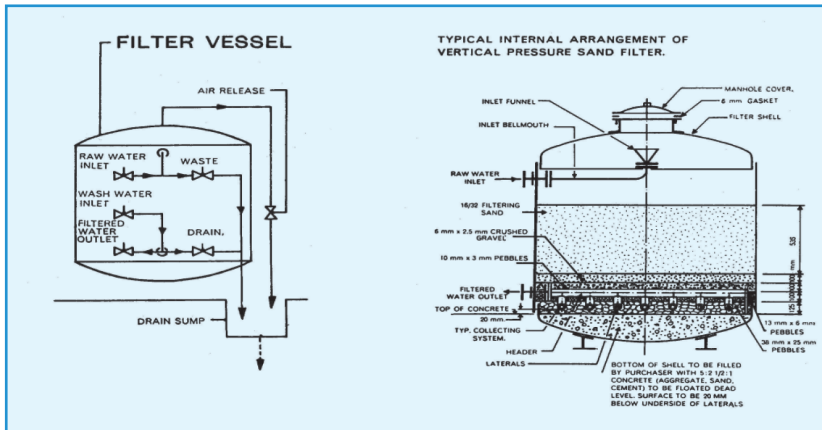

Fig 3.9 – Cross section drawing of vertical pressure sand filter

### 3.7.3.2 Horizontal pressure sand filter

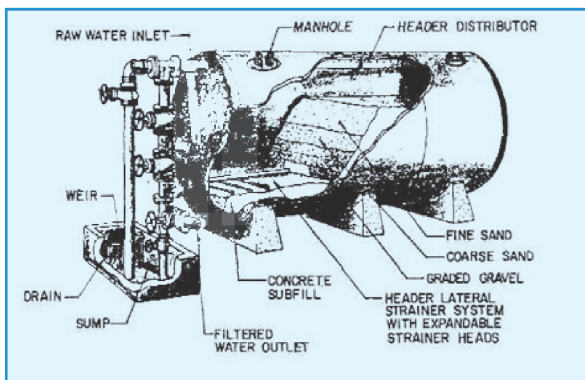
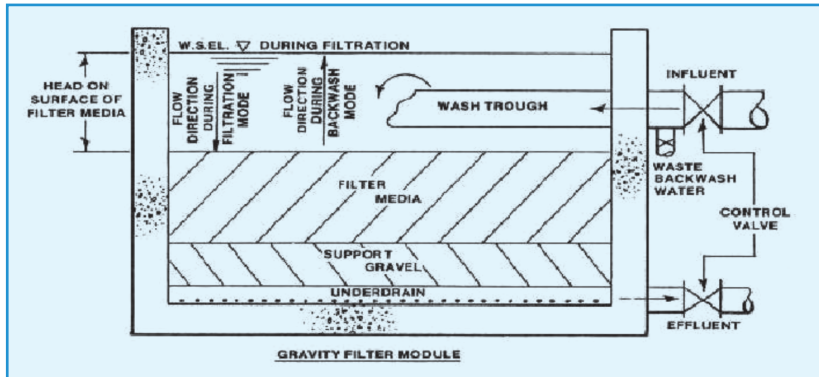

Fig 3.10 Cross section drawing of horizontal pressure sand filters

### 3.7.4 Rapid gravity sand filter

Rapid gravity sand filters are used to handle large flow rates. The major parts of a rapid gravity sand filter are the filter tank or filter box, filter sand or mixed media, gravel support bed, underdrain system, wash water troughs and filter bed agitators.



*Fig 3.11 - Cross section drawing of rapid gravity sand filter*

The filter tank is generally constructed of concrete and is most often rectangular. Filters in large plants are usually constructed next to each other in a row, allowing piping from the sedimentation basins to feed the filters from the central pipe gallery. Some smaller plants are designed with filters forming a square of four filters, with a central pipe gallery feeding the filters from a centre wall.

Filters are rated for a normal flow rate of 5 m/h. They can be operated up to 10 m/h either with anthracite and sand or with coarse sand. This is the filter of choice for large capacity units such as those for municipal use and produces filtrate quality turbidity - usually less than 1 NTU. The filter needs very little maintenance.

### 3.7.5 Filter-Pak

The Filter-Pak is also a gravity filter, and is a heavy-duty, self-cleaning installation that uses vigorous air scour with water backflush. The Filter-Pak successfully incorporates the economic advantages of roughing filtration followed by polishing, with air scour. All flow control and operation components necessary for automatic operation are provided with the unit. Filter compartments can be either square or rectangular to meet the space requirements of a specific site.

Filter-Pak offers two-stage filtration: roughing followed by fine polishing. This is accomplished by the use of a layer of relatively coarse, low-density material at the top, and a fine-particle polishing material at the bottom of the filter bed. The depth filtration obtained with combination media permits higher solids accumulation within the depth of the filter bed to a given head loss end point. Alternative designs are also available without air scour or with rotary surface washers according to specific plant requirements.

### **Advantages**

Some of the advantages include:

- Heavy duty (high turbidity influent) filtration capability because of the depth filtration
- Handles high turbidity loads and difficult particles
- The media stays clean even with difficult particles because of the vigorous air scour preceding the backwash using a unique strainer
- Can be operated at higher than normal flow rates on moderately turbid waters
- Air scour also substantially reduces the volume of water required to clean the filter
- Substantial cost savings are possible because the filters provide their own backwash water, thus eliminating all of the equipment needed for backwash in a conventional gravity filter
- Filter layout, cell size and number of cells are infinitely variable to suit any plant space and flow requirements
- Produces consistently high quality effluent by positive-head, gravity flow without the need for pumps, siphons or vacuum pumps
- Valves and controls are accessible for easy maintenance. Inlet flow distribution is achieved hydraulically, without complex instrumentation and flow control

#### **3.7.6 Continuous sand filter (CSF)**

These are gravity filters where water flows by gravity through an inlet distributor in the lower section of the unit. It gets filtered as it moves upwards through the clean sand that is moving downwards.

An airlift pump re-circulates the dirty sand through the central pipe and it is cleaned by a sand washer. Filtered water flows out through the filtered water outlet while wash water is removed through the wash water outlet.

The filter operation is continuous as the dirty sand gets cleaned on a continuous basis and is returned back. These filters can handle higher amounts of suspended solids and are ideally suited for mill scale filtration in the steel industry.

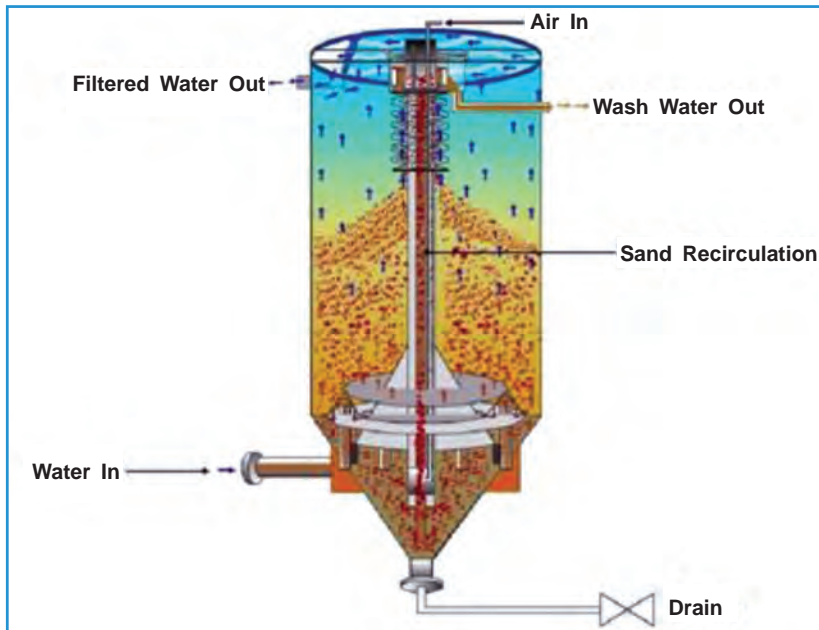

*Fig 3.12 – Cross section drawing of continuous sand filter*

### **Process parameters**

The filter can handle inlet suspended solids load as high as 200 ppm as well as oil up to 20 ppm. It produces treated water with less than 2 ppm suspended solids.

The units are of steel construction and are built in concrete for higher flow requirements.

Features	Advantages
Continuous service flow	Less manpower required
Continuous backwash operation	Removes oil effectively without “mudballing” effect
	Eliminates backwash downtime, requirement of backwash accessories like storage tanks, blowers & pumps
	Simple wash water handling
Handles suspended solids load up to 200 ppm	Eliminates requirement of clarifier for medium loads
Operates at atmospheric pressure	Low energy consumption
Simple modular construction with minimum moving parts	Low operation, space saving, easy capacity expansion

Applications include mill scale filtration, filtration of raw water for potable use and for treating industrial process water, filtration of cooling tower side stream filtration and make-up, recycling of white water in the pulp and paper industry and tertiary treatment of sewage.

### 3.7.7 Auto valveless gravity filter (AVGF)

An auto valveless gravity filter (AVGF) is a highly efficient gravity filter that operates automatically without a single valve, backwash pump, flow controller or any instruments. The filter operates on the loss of head principle.

As the filter bed collects dirt during the filter run, head loss increases and the water level rises in both the inlet and backwash pipes. The backwashing thus begins when the siphon is established.

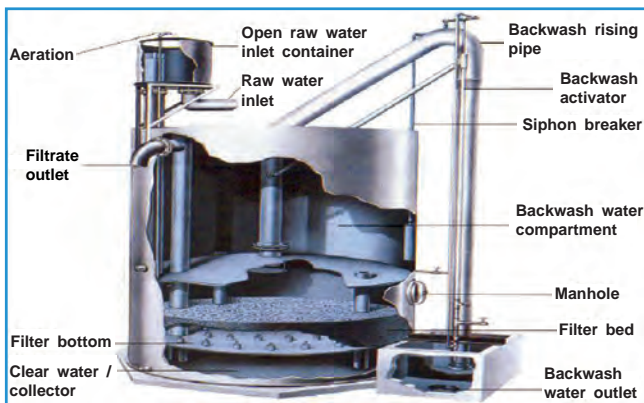

Fig 3.13 – Cross section drawing of AVGF

## **Operation of AVGF**

### **Filtering**

Water from the constant head box passes down the inlet pipe and enters the filter through inlet weir box. Air is released through the air vent provided. Water flows down through the filter media and strainers into the collector chamber. Dirt and suspended impurities are trapped on the bed. Clean water flows upward through the effluent duct and after the backwash chamber is filled, it flows through the effluent pipe to service.

### **Filtration over a period of time**

As the filter bed collects dirt during the filter run, the head loss increases gradually, and the water level rises in the inlet and backwash pipe. Just before the water passes over into the downward section of the backwash pipe, a small portion flows into the ejector supply line, through the ejectors, and into the sump. The water flowing through the ejector evacuates air from the backwash pipe. This pulls water rapidly over into the pipe so that a large volume of water flows down the backwash pipe and starts the siphon action.

### **Backwashing**

Once the siphon has been established between the filter and the sump, the pressure immediately above the filter bed is lower than the pressure in the backwash chamber. This causes water from the backwash compartment to flow down through the effluent duct, into the collector chamber and upwards through the strainers, expanding the bed and cleaning it. The backwash water with dirt passes up the backwash pipe, over the U-bend and out through the sump, to waste.

### **Siphoning breaking action**

The backwash continues until the level in the backwash chamber drops below the siphon breaker. When this happens, air is admitted to the top of the backwash pipe and backwashing stops.

The inlet water automatically resumes its downward gravity flow through the filter bed and so on as the siphon is broken. The first water to be filtered rinses the bed and flows up into the backwash chamber where it is stored for the next backwash.

The filter is suitable for inlet raw water suspended solids up to 25 ppm to give consistent treated water quality of less than 2 ppm.



### Features and advantages

Features	Advantages
Automatic backwash	Reliable. No manpower required for monitoring
No valves, instrumentation and backwash pumps	No controls required, cost-effective
Works on gravity	Does not require compressed air, hydraulic or electric energy
Compact and modular design	Low installation and expansion costs
Backwash can be initiated manually (if required)	Flexibility in operation
Handles inlet suspended solids load up to 25 ppm while giving consistent high quality treated water of less than 2 ppm	
Rinse water through a freshly backwashed AVGF is not discarded but stored and used for the next backwash cycle	Saves water
Depending on the media and type of treatment the surface loading varies from 5 m/h to 8 m/h	Higher surface loading rate compared to gravity filter

### 3.7.8 Activated carbon filter

#### 3.7.8.1 De-chlorination

There are primarily four areas where activated carbon filters are used. In water treatment - removal of free residual chlorine (FRC), removal of oil from condensate, removal of low molecular weight organic compounds and removal of pesticides from drinking water. Free residual chlorine (FRC) present in feed water to demineralising (DM) plants oxidises the sulphonic acid groups present in strong acid cation exchangers. This results in a drop in the exchange capacity of the cation resin. The displaced sulphonic acid groups can irreversibly foul the anion exchange resin.

Free residual chlorine is also harmful to reverse osmosis (RO) membranes and needs to be removed completely from feed water.

**INDION** ROC resin is also used for free chlorine removal and pretreatment of RO. De-chlorination is carried out using an activated carbon filter or by addition of sodium sulphite. Carbon filters are preferred as they can produce water free from FRC even if the inlet has higher chlorine content.

The dosage of sodium sulphite needs to be adjusted every time there is an excursion of free chlorine in filtered water.

Each ppm of free chlorine requires 2.6 mg/l of sodium sulphite ( $\text{Na}_2\text{SO}_3$ ) or 2.92 mg/l of sodium bi sulphite ( $\text{NaHSO}_3$ ) or 2.67 mg/l of sodium meta bi sulphite ( $\text{Na}_2\text{S}_2\text{O}_5$ ).

Activated carbon needs to be replaced once a year or whenever FRC at the outlet of the activated carbon filter is positive.

### **3.7.8.2 Removal of organic matter**

Activated carbon with large (meso) pores can remove low molecular weight organic compounds. The carbon should have high surface area and high porosity.

### **3.7.8.3 Removal of pesticides**

Beverages and packaged drinking water should be free from pesticides. A special grade of carbon is used for this purpose.

### **3.7.8.4 Removal of oil (hydrocarbons) from condensate**

Condensates can get contaminated with hydrocarbons during use in heat exchangers and removal of oil is essential before the condensate can be returned back to the boiler.

Oil in condensate can be removed by filtration through activated carbon filters.

For removal of oil from condensate, carbon is used in two columns in series. The primary column removes oil by straining and the secondary column removes it by adsorption. Piping is done in such a way that it can be interchanged. At the end of one year, carbon in the first column is replaced with fresh carbon once a year and the units are interchanged.

### **3.7.9 Micron cartridge filter**

Micron cartridge filters consist of cartridge elements housed in a pressure vessel and are used to remove particles smaller than 50 microns (one micron =  $10^{-6}$ ) in size. They are primarily used to protect the RO feed membranes from getting damaged by particles in feed water. They are available in different constructions

String wound cartridges are constructed by winding a cord made usually of polypropylene around a perforated center core. The cord is tightly wound near the core, and loosely wound on the surface, resulting in depth filtration.

Pleated cartridges are built by laying flat stock around a central core and dipping the ends into molten plastic. The pleats provide a large surface area for high holding capacity.

Resin bounded cartridges are produced cellulose fibre glass strands or fibres coated with resin. Spun polypropylene (also called melt blown) cartridges are products of molten polypropylene injected into a high velocity air stream.

Cartridges are rated by micron rating. A 10 micron nominal rated cartridge, for example, will remove 85% particles above 10 microns at the recommended flow rate. A 10 micron absolute cartridge will remove all particles above 10 microns.

Micron cartridge filters are generally not backwashable and need to be replaced when the pressure drop across the filter exceeds the set limit.

# Chapter 04

## PRETREATMENT OF GROUND WATER

**Arsenic removal plant for ground water treatment**



**Fluoride removal plant for community drinking water systems**



**Iron removal & softening system for housing society**





## 4.0 PRETREATMENT OF GROUND WATER

### 4.1 Introduction

Ground water is drawn through bore wells, artesian wells and ranney wells and is relatively free from undissolved impurities as it gets filtered by the strata before it is pumped to the ground.

Artesian wells are those where water comes out on its own pressure without the need for pumping. Ranney wells are relatively shallow wells located in the riverbed and water is drawn through a header lateral type collecting system located in the aquifer below. Here again there is no need for a clarifier as water gets filtered as it comes through layers of sand.

Ground water is likely to contain moderate to high levels of dissolved solids. In some cases it may contain excessive amounts of contaminants like iron, manganese, arsenic, fluoride and nitrates.

In the absence of a river or a lake, people are entirely dependent on ground water sources. While at some locations water may be available at reasonably lower depths this may not be the case elsewhere. Some bore wells may yield water of reasonably good quality, while water from other locations may be brackish. In some areas water may contain excessive amounts of iron, manganese, fluoride, arsenic or other contaminants.

Continuous extraction of water is not advisable and enough intervals should be given before re-pumping to enable recharging of the well. Rain water harvesting is the best way to improve both water table and water quality.

Pretreatment of ground water will therefore depend entirely on the quality of water available at a given location.

As a general rule, ground water is relatively very low on suspended solids and turbidity and hence does not require elaborate pretreatment.

Ground water is high on dissolved solids, hardness, alkalinity and silica. Partial or complete removal of dissolved impurities by reverse osmosis (RO) and/or by ion exchange process may be required. The pretreatment will consist of a filter to remove sand particles that may come along with the bore well water, and a micron cartridge filter to protect the membrane filter.

At a number of places ground water contains contaminants like iron, manganese, fluoride, arsenic, nitrates and pesticides. These contaminants have to be removed before treating the water for dissolved solids removal.

## 4.2 Iron and Manganese

### Methods of removal

Iron is present in ground water mostly as ferrous bicarbonate. Such water is clear when drawn but soon becomes turbid with brownish precipitates of iron oxide. The economical way to remove iron is to aerate the water preferably in the form of a fountain.

Water comes into contact with copious amounts of oxygen which oxidises the ferrous salts into insoluble ferric hydroxide. Simultaneously, the process removes carbon dioxide and elevates the pH, both of which aid precipitation. The ideal pH is 8.5 and above. Addition of a coagulant (sodium aluminates) can improve the process.

Iron can also be removed by catalytically using an iron removal filter. The filter medium could be granular manganese ore or a resin media (**INDION**® ISR).

**INDION**® ISR (Iron Specific Resin) is based on ion exchange resin technology and has manganese dioxide as a catalyst. It works as a catalyst to promote iron oxidation. Basically, iron and oxygen are attracted to manganese dioxide, which enhances the oxidation of dissolved iron and converts the soluble iron (Fe<sup>2+</sup>) into insoluble ferric (Fe<sup>3+</sup>); it also converts soluble manganese into insoluble manganese oxide, which can be filtered through the media which acts as catalyst in this process. Being a catalyst it does not get consumed in the reaction; hence life of the media is very high.

In some cases, water may be coloured indicating possible contamination by organic matter; it is also possible that the water has bacteria. In both cases oxidation by chlorine or hypochlorite is recommended.

Some water may contain both iron and manganese. The ideal pH for precipitation of manganese salts is 9.5 and above. The best way to remove both the impurities is to dose a dilute solution of KMnO<sub>4</sub>. Addition of alkali will be required to elevate the pH. Once the salts are precipitated, they can be removed either in a clarifier or in a granular media filter.

Each ppm of iron requires 1 ppm of KMnO<sub>4</sub> and each ppm of manganese requires 2 ppm of KMnO<sub>4</sub> for complete removal.

## 4.3 Fluoride

### Methods of removal

There are areas where the ground water contains fluoride in excess of limits prescribed by drinking water standards. Prolonged consumption of

water with high fluoride concentrations can cause dental fluorosis and, in extreme cases, even skeletal fluorosis. The World Health Organization guideline for fluoride in drinking water is 1.5 mg/l (WHO, 2011).

The traditional method of removal of fluoride is by precipitation of fluoride by lime which precipitates fluoride as calcium fluoride. However this method is not suitable as the solubility of  $\text{CaF}_2$  is around 8 mg/l as F.

Fluoride can also be removed by treating with an adsorbent like activated alumina. The optimum pH for adsorption is between 5 and 7. However removal of fluoride is not complete. Recent studies have shown that alum impregnated activated alumina (AIAA) is more effective and rapid. Optimum pH is 6.5 which is ideally suited for drinking purposes.

AIAA can be reused by rinsing the fluoride adsorbed material with 0.1M NaOH at pH 12 followed by neutralising with 0.1M HCl.

Alum impregnated activated alumina can effectively remove upto 0.2 mg/l from water containing 20 mg/l of fluoride.

The most effective method is to use a fluoride removal resin (**INDION**® RSF-10/FR-10). The resin is specially developed to reduce fluoride in water from 10 ppm to <1.5 ppm, which is as per the permissible limits for drinking water.

In a typical hand pump attachment unit, the stages are as follows:

Stage I: As raw water flows through the unit the fluoride ions are adsorbed on the resin matrix to bring down the concentration of fluoride to safe levels.

Stage II: The water then passes through the polishing media which acts on any residual levels of fluoride to further reduce the levels.

In the final stage the pH correction media restores the pH levels within the drinking water limits by taking care of the excess acidity or alkalinity in the water.

The first media will get exhausted based on the fluoride levels and water consumption. On exhaustion, the unit can be regenerated using PAC (Poly Aluminium Chloride). Commonly available lime and ferrous sulphate are used to precipitate the fluoride and can be safely disposed of. The life of the resin is 2-3 years.

### **Membrane processes**

Reverse osmosis membrane process removes fluoride up to 95% and also reduces TDS.  $\text{CaF}_2$  can severely scale the RO membrane and hence softening of water is necessary to convert  $\text{CaF}_2$  to NaF which can be removed by RO.



Otherwise use of antiscalant allows concentration to be 125 times the solubility product ( $K_{sp}$ ), thus obviating need for softening in most cases, which is important for large plants or recycle plants.

## 4.4 Arsenic

### Methods of removal

Ground water in some areas of the world contain arsenic in excess of the permissible limits. Arsenic is present as  $As^{+3}$  and needs to be converted to  $As^{+5}$  form before it can be removed.

The process for removal of arsenic involves the oxidation of trivalent arsenic to pentavalent arsenic followed by its adsorption on activated alumina, hydrated ferric oxide and oxides of cerium, zirconium and titanium. The adsorption process is primarily applied to ground water having low turbidity.

Arsenic present in ground water is best removed by selective arsenic removal media (for example **INDION** ASM). It is developed using a novel technique by impregnating nano particles of iron on polymer supporting material, for selective removal of arsenic from ground water without altering any water quality parameters. The media performs well in presence of common anions such as chlorides, sulphates or bicarbonates.

This media does not require pretreatment. The media has affinity for trivalent and pentavalent arsenic and can tolerate maximum 3000 ppb of arsenic. The media is non-toxic and safe for disposal as per TCLP and EPA 1311. It is easily adaptable and can be used for point of entry (POE), point-of-use and community based needs.

## 4.5 Nitrates

### 4.5.1 Methods of removal

Nitrate contamination originates mainly from agricultural operations including farm runoff and fertiliser usage, septic system failure and improper discharge of industrial and food processing waste and waste water. Since they are very soluble and do not bind to soils, nitrates have a high potential to migrate to ground water. The primary inorganic nitrates which may contaminate drinking water are potassium nitrate and ammonium nitrate, both of which are widely used as fertilisers.

High nitrate concentration is a potential hazard. Nitrate ions form complexes with blood and in the long run cause oxygen depletion affecting human life.

Nitrates can be removed effectively by ion exchange process or by reverse osmosis.

#### **4.5.2 Nitrate removal by ion exchange process**

Nitrates can be removed by a special ion exchange resin (**INDION**<sup>®</sup> NSSR). This is a macroporous strongly basic anion exchange resin tailor-made to remove nitrate ions from water. The proper mix of physico-chemical properties gives ideal nitrate exchange kinetics making it suitable for nitrate removal in the presence of sulphates.

#### **4.5.3 Nitrate removal by reverse osmosis**

In case water is being treated by RO for removal of TDS, the process will also remove nitrates along with other ions. No specific pretreatment is required in this case.

### **4.6 Removal of Pesticides**

#### **Methods of removal**

Bore well water may contain higher levels of pesticides which need to be removed from packaged drinking water by employing a special grade of activated carbon for removal of pesticides.

The advantage of the process lies in the fact that the pesticides are adsorbed on the carbon and form a complex that does not leach out the pesticides, and hence disposal of exhausted carbon does not pose a problem.



# Chapter 05

## POTABLE WATER TREATMENT

**Ozonator and UV steriliser**



**Electro chlorinator**





## 5.0 POTABLE WATER TREATMENT

### 5.1 Introduction

Water used for potable purposes must meet the requirements laid down in IS 10500. Annexures – 20 & 21 give information on Indian Standards and WHO standards.

Water must be clear and free from objectionable colour, taste or odour.

It must be low in dissolved solids and hardness and free from pathogenic (disease causing) bacteria.

Other contaminants like fluoride, arsenic, iron, manganese and nitrates must not be present in quantities in excess of permissible limits.

Municipalities draw water from rivers, canals or lakes, treat it in a central treatment plant and supply it to the various zones in the municipality. Water is pre-chlorinated, clarified, filtered and re-chlorinated before distribution.

In smaller towns, where access to surface water is not available and only ground water is available, water for drinking will be made available after the ground water is treated and distributed for human consumption.

In either case, if the distribution lines are very old, contamination of drinking water is likely to occur. In some cities, sewer lines run close to water mains and in this case contamination of drinking water can take place.

Hence, it is now an accepted practice to use online water purifiers at homes, offices, restaurants and other public places to eliminate pathogenic bacteria and make the water safe to drink.

### 5.2 Disinfection of Water

Disinfection is achieved by:

- Chlorine, chlorine dioxide, electro chlorination and ozone
- Hydrogen peroxide and solutions of chlorine compounds such as sodium or calcium hypochlorite
- Ultra violet radiation
- Heat - boiling and steaming
- Combinations of the above

### 5.2.1 Chlorine (Cl<sub>2</sub>)

Chlorine is the most commonly used reagent for the disinfection of water. It cannot be used directly in the gaseous state and must first be dissolved in water.

It reacts in water to form hypochlorous acid (HOCl) which dissociates to the hypochlorite ion (OCl<sup>-</sup>)

The reactions are



The above equilibria are pH dependent. The figure below shows the quantity of chlorine present in the form HOCl and OCl<sup>-</sup> for pH between 5 and 10.

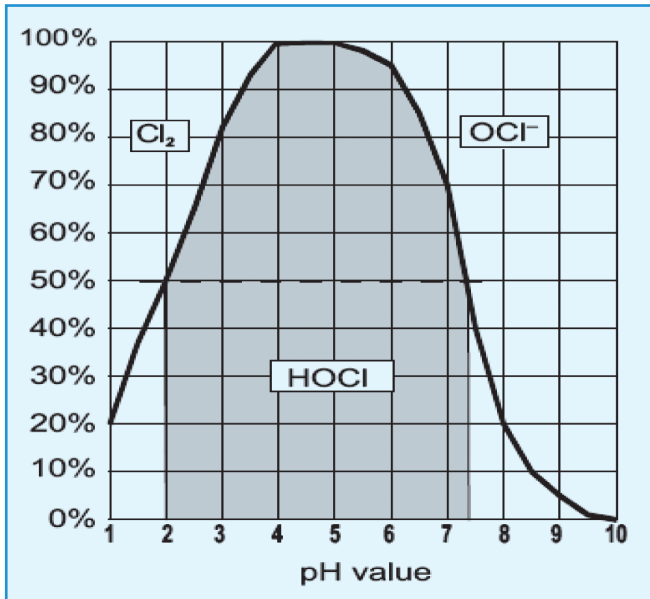

The bactericidal effect of chlorine is maximum when chlorine is in the HOCl form. Hence, chlorine is an effective disinfectant at pH between 5 and 6.

HOCl and OCl<sup>-</sup> together constitute free available chlorine; along with combined chlorine - monochloramine, dichloramine and trichloramine - the total residual chlorine is obtained. Chlorine possesses significant residual power.

## Breakpoint chlorination

The graph below shows what happens when chlorine (either chlorine gas or a hypochlorite) is added to water. First (between points 1 and 2), the water reacts with reducing compounds in the water, such as hydrogen sulphide. These compounds use up the chlorine, producing no chlorine residual.

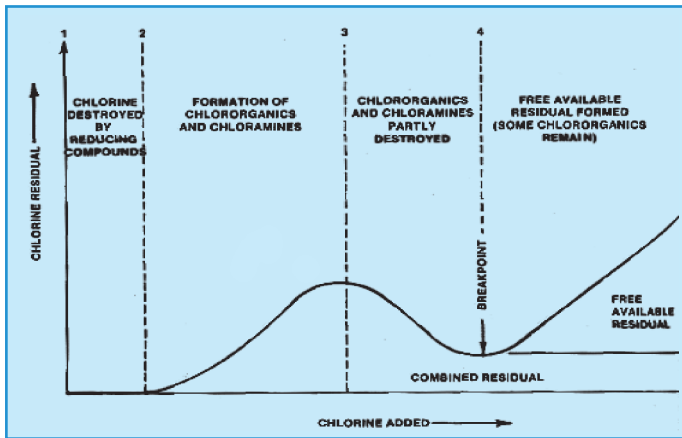

Next, between points 2 and 3, the chlorine reacts with organics and ammonia naturally found in the water. Some combined chlorine residual is formed - chloramines. Note that if chloramines were to be used as the disinfecting agent, more ammonia would be added to the water to react with the chlorine. The process would be stopped at point 3. Using chloramine as the disinfecting agent results in little trihalomethane production but causes taste and odour problems since chloramines typically give a “swimming pool” odour to water.

In contrast, if hypochlorous acid is to be used as the chlorine residual, then chlorine will be added past point 3. Between points 3 and 4, the chlorine will break down most of the chloramines in the water, actually lowering the chlorine residual.

Finally, the water reaches the breakpoint, shown at point 4. The breakpoint is the point at which the chlorine demand has been totally satisfied - the chlorine has reacted with all reducing agents, organics, and ammonia in the water. When more chlorine is added past the breakpoint, the chlorine reacts with water and forms hypochlorous acid in direct proportion to the amount of chlorine added. This process, known as breakpoint chlorination, is the most common form of chlorination, in which enough chlorine is added to the water to bring it past the breakpoint and to create some free chlorine residual.



### 5.2.2 Chlorine dioxide

Chlorine dioxide ( $\text{ClO}_2$ ) is a synthetic, green-yellowish gas with a chlorine-like, irritating odour. Chlorine dioxide is a neutral chlorine compound. Chlorine dioxide is very different from elementary chlorine, both in its chemical structure as well as in its behavior. Chlorine dioxide is a small, volatile and very strong molecule. In diluted, watery solutions chlorine dioxide is a free radical. At high concentrations it reacts strongly with reducing agents. Chlorine dioxide is an unstable gas that dissociates into chlorine gas ( $\text{Cl}_2$ ), oxygen gas ( $\text{O}_2$ ) and heat. The end-products of chlorine dioxide reactions are chloride ( $\text{Cl}^-$ ), chlorite ( $\text{ClO}^-$ ) and chlorate ( $\text{ClO}_3^-$ ).

Major advantages of using chlorine dioxide as a disinfectant:

- High water solubility (upto 8 grams per litre at normal temperature and pressure)
- No trihalomethanes (THMs) are formed
- Low formation of DBPs (chlorites)
- Effective at low concentration
- More effective against viruses than chlorine or ozone
- Corrosion effects of chlorine dioxide are minimal
- Simple to maintain and effective
- Rapid microbial killing action
- Maintain biocidal activity upto pH 11
- Better tolerance to organics than chlorine or bromine
- Does not react with organics to form eco-toxic and bio-accumulative by-products
- Environmentally safe
- Excellent odour neutraliser
- Effective fogging and fumigation material

### 5.2.3 Electro chlorination

Electro chlorination is the process of producing hypochlorite by running an electric current through salt water.

The processes involved in electro chlorination are actually rather simple. The main idea involved is the desalination of water to produce a chlorinated solution. This happens when salt water is inserted into electrolyser cells. The first step is removing the solid excess from the salt water. Next, as the salt water runs it is streamed through a channel of decreasing thickness. One side of the channel is a cathode, the other

is an anode. As the water flows through the anode/cathode channel, a low voltage DC current is applied. When this happens, the electrolysis is triggered and sodium hypochlorite is instantly produced as well as hydrogen gas ( $H_2$ ). The hydrogen rich sodium hypochlorite then travels to a tank that removes the hydrogen gas. After hydrogen has been removed from the solution, it is stored in a tank as the finished product.



### Advantages

Electro chlorination chlorinates drinking water and does so in an eco-friendly way. It does not harm the environment in any measurable negative way. Unlike other chlorination techniques, electro chlorination generates no sludge or by-products. It also is safer for the operators of chlorinators as there is no handling of chlorine gas, which is highly toxic and corrosive.

### 5.2.4 Ozone ( $O_3$ )

Ozone is the most powerful oxidising reagent used in the treatment of drinking water. Due to its oxidising properties, ozone is used for disinfecting water. It acts rapidly and efficiently but does not have any residual power.

It is a gas which is produced on the site for use.

Ozone dissolves in water and the dissolved ozone then acts on the body to be oxidised.

The action of ozone is:

- by direct reaction of the ozone molecule
- through secondary species such as  $OH^-$  (hydroxyl) radicals formed when the ozone molecule decomposes in water

Ozone improves the colour and taste of drinking water; it destroys bacteria and viruses; oxidises organic matter, micro pollutants and metal salts (iron and manganese in solution).

### 5.2.5 Hydrogen peroxide ( $H_2O_2$ )

Hydrogen peroxide is a strong oxidising agent which breaks down in water according to the reaction



Its high cost limits its use to specific purposes.

As a bactericide it is used to disinfect pipes in a system supplying ultra pure water.

The advantage of this oxidising agent is that it does not cause the formation of halogen compounds, nor does it add to TDS.

It may be used in combination, with other oxidising agents such as ozone. Ozone will react with the  $\text{H}_2\text{O}_2$  ion to form  $\text{OH}^-$  radicals whose oxidising action has been cited above.

The reaction with ozone is

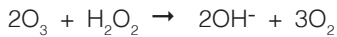

Hydrogen peroxide is available commercially in solutions of 35%, 50% and 70% of  $\text{H}_2\text{O}_2$  by weight. It is unstable as such and its stability is improved through additives.

### 5.2.6 Sodium hypochlorite ( $\text{NaOCl}$ ) and calcium hypochlorite ( $\text{Ca(OCl)}_2$ )

Sodium hypochlorite and calcium hypochlorite when dissolved in water break down as follows:

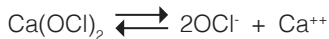

The preponderance of the pH reaction will thus be in the oxidising or bactericidal action of these oxidising agents.

What has been said earlier for chlorine is applicable to sodium hypochlorite and calcium hypochlorite also.

Sodium hypochlorite is available commercially as a solution with concentration of active chlorine up to 150 g/l. It is used in situations where safety considerations preclude the use of chlorine gas.

The strength of sodium hypochlorite solution decreases with time and hence it is important to check the concentration frequently.

Sodium hypochlorite can be produced in situ by electrolysing brine or sea water.

Calcium hypochlorite is available in solid form in concentration reaching 90-95% of  $\text{Ca(OCl)}_2$  and has a very high active chlorine content equivalent to 650-700 g/kg. It is used where transport costs would make regular supplies of chlorine gas or sodium hypochlorite solution difficult.

### 5.2.7 Ultra violet (UV) radiation

UV radiation is part of spectrum called electromagnetic radiation - shorter than 400 nanometre wavelength.

Ultra violet radiation at wavelengths between 200 and 300 nm has a powerful germicidal effect which is at its maximum around 254 nm.

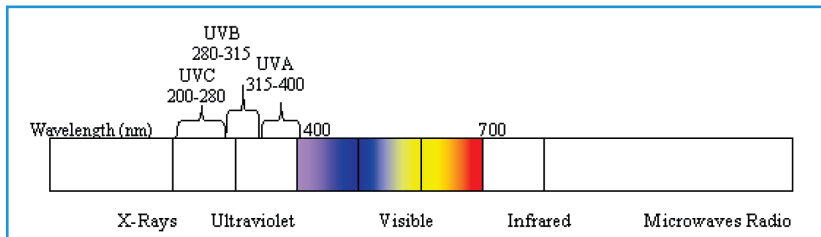

Exposure to ultra violet radiation can therefore be used to remove bacteria and viruses without the addition of chemicals.

The combined action of UV rays and ozone facilitates the OH<sup>-</sup> radical forming action of ozone according to the reactions

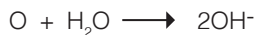

Hence, ultra violet radiation is used in combination with ozone to provide synergy of the individual disinfectants.

The degree of UV radiation absorbed by water depends on factors such as turbidity, the presence of metals and organic matter. It is used mostly in the production of ultrapure water. Its great advantage is that of not introducing foreign substances to the water. UV does not have residual power.

UV radiation is produced by high-pressure or low-pressure mercury-vapour lamps. The low-pressure lamps emit lower powered radiation but are more energy efficient and longer lasting than the high-pressure lamps.

### 5.2.8 Heat

All bacteria and most viruses in water are destroyed by the action of heat when water is boiled for a few minutes.

The practice of boiling water for drinking purposes is widely used in homes. The disadvantage with boiling is that it is not instant; water has to be cooled before consumption and the stored water must be protected from possible recontamination.

In the pharmaceutical industry the technique of heat is used for disinfection and sterilisation apart from the other methods mentioned previously. Thus pipelines and equipment are sterilised with steam; and water is heated to 80° C or boiled for certain applications.

# Chapter 06

## ION EXCHANGE PROCESSES

**Demineralisation plant  
for a refinery project**



**Softening plant  
at a sugar mill**



**Resins**

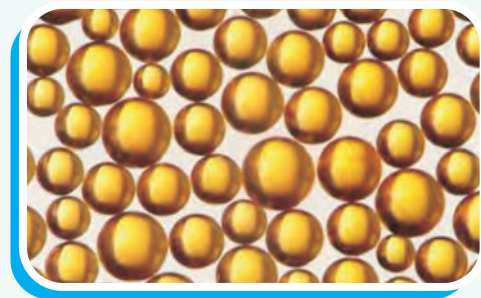

**Uranium recovery at a  
uranium manufacturing  
plant**





## 6.0 ION EXCHANGE PROCESSES

### 6.1 Introduction

Ion exchange processes involve the use of ion exchange resins. Ion exchange resins are synthetic copolymers of styrene and divinylbenzene/ acrylic acid to which are attached functional groups which then behave like acids, alkalis or salts. Ion exchange processes are used for removal of hardness, alkalinity or complete removal of dissolved solids from water. The ion exchange process is reversible and hence the resins can be used over and over again.

**Softening:** A strongly acidic cation exchange resin in sodium form, for example, removes hardness from water by exchanging sodium ions present in the functional group with the calcium and magnesium ions present in water. Once exhausted, the ion exchange resin can be restored to its original form by regeneration with common salt and used all over again.

**Dealkalisation:** A weakly acidic cation exchange resin in hydrogen form removes carbonate (or temporary) hardness from water by exchanging hydrogen ions present in the functional group with the calcium and magnesium ions associated with alkalinity present in water. Once exhausted, the ion exchange resin can be restored to its original form by regeneration with a mineral acid and used all over again. The resin does not remove permanent hardness.

**De-silicisation :** The process uses strong base anion exchange resin in hydroxide form and removes silica from water. The process is applicable for waters having low TDS but containing moderate to high levels of silica.

**Demineralisation:** The process uses two types of resins - a strongly acidic cation resin and a strongly basic anion resin, housed in two different vessels in series.

The cation resin is used in hydrogen form, and exchanges its hydrogen ions with the cations (calcium, magnesium and sodium) present in raw water and converts the salts into corresponding acids. The alkaline salts are converted into carbonic acid and the neutral salts into mineral acids (HCl, H<sub>2</sub>SO<sub>4</sub> and HNO<sub>3</sub>).

The anion resin is used in hydroxide form and exchanges its OH ions with the anions like chlorides, sulphates or nitrates present as mineral



acids in treated from cation unit. The net result is production of pure demineralised water free from salts.

Once exhausted, the cation resin is regenerated with acid and anion resin with alkali thus regaining original ionic forms.

## 6.2 Ion Exchange Resins

The basic polymeric structure or solid support for ion exchange resins is called the matrix. The matrix is a three dimensional copolymer on which acidic or basic sites are situated. These acidic or basic sites are called functional groups or functionality of the ion exchange resin. The matrix along with these functional groups is called a functional polymer, or ion exchanger, or simply resin.

The chemical reactions involved in the ion exchange process are reversible since these are governed by the Law of Mass Action; and hence ion exchange resins can be repeatedly converted from one ionic form to another and back and reused. The process of converting the ion exchange resins to the desired ionic form at the end of cycle of its intended use is known as 'regeneration'.

Ion exchange resins can be broadly classified into the following four categories:

1. Strong acid cation (SAC) exchange resin
2. Weak acidic cation (WAC) exchange resin
3. Strong base anion (SBA) exchange resin
4. Weak base anion (WBA) exchange resin

### 6.2.1 Strong acid cation exchange resin

All the major strong acid cation exchange resins involved in industrial water treatment applications have a chemical matrix consisting of styrene and divinylbenzene. The functional groups are sulfonic acid radicals. The resins vary mainly in divinylbenzene content or matrix structure (gel/isoporous/macroporous).

Generally, in water softening, a strong acid cation exchange resin with 6 - 8% divinylbenzene crosslinking is used. **INDION** 220 Na and **INDION** 225 Na are examples of this resin.

For demineralisation the main resin that is used is the cation resin in hydrogen form, for example **INDION** 225 H.

### 6.2.2 Weak acid cation exchange resin

In industrial water treatment applications, weak acid cation exchange resin is used primarily where there is a high degree of hardness and a high degree of alkalinity. This resin has the capacity of exchanging all cations associated with alkalinity to a much greater degree than strong acid cation exchange resins. A weak acid cation exchange resin consists of polyacrylic acid divinylbenzene matrix with carboxylic functionality and gel structure. The major advantage of this resin is that it can be regenerated with stoichiometric amounts of regenerant, and is, therefore, much more efficient. **INDION** 236 is an example of this resin.

### 6.2.3 Strong base anion exchange resin

Strong base anion exchange resins can be divided into two categories called Type I and Type II. The Type I resin has the highest overall basicity and, therefore, gives best effluent quality. The Type II resin also removes anionic constituents, but has lower basicity and, therefore, requires less caustic during the regeneration cycle. In general, a Type II strong base anion exchange resin is recommended where silica concentration in treated effluent is not as critical, and also where a relatively high chloride and/or sulphate content prevails in the raw water. **INDION** FFIP is an example of Strong Base Type I and **INDION** NIP of Strong Base Type II anion resin. These are isoporous resins and are not fouled by organic matter present in most surface waters. The organics are eluted during regeneration.

For applications where higher physical strength is required, macroporous resins are also available e.g. **INDION** 810.

All strong base anion exchange resins continuously undergo hydrolysis - a process that converts the strong base groups present in the resin into weak base groups. The net result is a gradual loss of capacity to remove weak acids like carbon dioxide and silica. Type II resins undergo hydrolysis at a faster rate as compared to Type I resins. Type I resins are therefore preferred where low residuals of silica are required in treated water.

### 6.2.4 Weak base anion exchange resin

In the field of deionisation, weak base anion exchange resin is used primarily to remove strong acids such as hydrochloric and sulphuric acid. Unlike strong base anion exchange resin, weak base resin does not have the capability to remove carbon dioxide and silica; however it has a much higher capacity for the removal of chlorides and sulphates. The resin can be of gel or macroporous structure. For treatment of water which does not present organic fouling problems, the gel type

weak base resin is used. For treatment of water containing organic contaminants (humic and fulvic acids), macroporous weak base anion resins are preferred. **INDION** 850 is an example of macroporous weak base anion resin.

A procedure for determination of operating exchange capacity is given in Annexure-4.

## 6.3 Ion Exchange Process

### 6.3.1 Softening

The process involves the use of a strong acid cation exchange resin in sodium form which exchanges calcium and magnesium ion in water with sodium ions. The treated water is now soft (free from calcium and magnesium) and does not form scales.

The process does not remove any other contaminant like alkalinity, chlorides, sulphates, nitrates or silica. Total dissolved solids remain practically the same. pH remains unaltered. The process however increases its potential for corrosion. The other problem associated with softening by ion exchange process is the problem of disposal of saline effluent.

On exhaustion, the resin is regenerated with common salt, normally referred to as brine with 15% NaCl content solution which restores the resin back to its original form.

Soft water is used as makeup for cooling water systems. It is used in processing of textiles and many other applications where soft water is required.

#### **Service cycle:**



#### **Exhaustion cycle:**

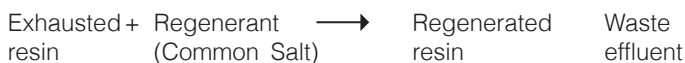

Regeneration equipment includes a salt saturator (for making a saturated solution of salt and holding enough salt solution to last for several days), a brine measuring tank (to hold enough salt solution for one regeneration) and an hydraulic ejector to inject a 15% w/v solution of salt (also called brine). Salt may also be injected using a metering pump.

Regeneration involves the following steps:

- Backwash to remove any dirt that might have accumulated at the top of the column and also to loosen the bed
- Brine injection to regenerate the resin
- Fast rinse to remove the salt solution remaining in the column

The effluent is rich in salt and cannot be directly disposed of either into land or sewer.

### 6.3.2 Dealkalisation

The term dealkalisation refers to removal of alkalinity from water. There are at least three methods for removal of alkalinity:

1. **Split stream dealkalisation:** A strong acid cation resin in hydrogen form is used in parallel with a strong acid cation resin in sodium form. Acidity present in the effluent from the first unit is neutralised by the alkalinity present in the effluent from second unit. On exhaustion, the first unit is regenerated with acid and the second with salt.
2. **Dealkalisation using weak acid cation (WAC) resin:** The process removes alkalinity associated with hardness. It removes only carbonate or temporary hardness and does not remove permanent hardness. It also reduces the dissolved solids to the extent hardness is removed. On exhaustion the resin is regenerated with acid equal to 105% of the work done by the unit.
3. **Combination of WAC with softener:** The process involves the use of a weak acid cation unit in hydrogen form and a softener working in series. The weak acid cation resin removes temporary hardness and the softener removes the permanent hardness. On exhaustion, the WAC unit is regenerated with acid and the softener with salt.

## A) Split Stream Dealkalisation

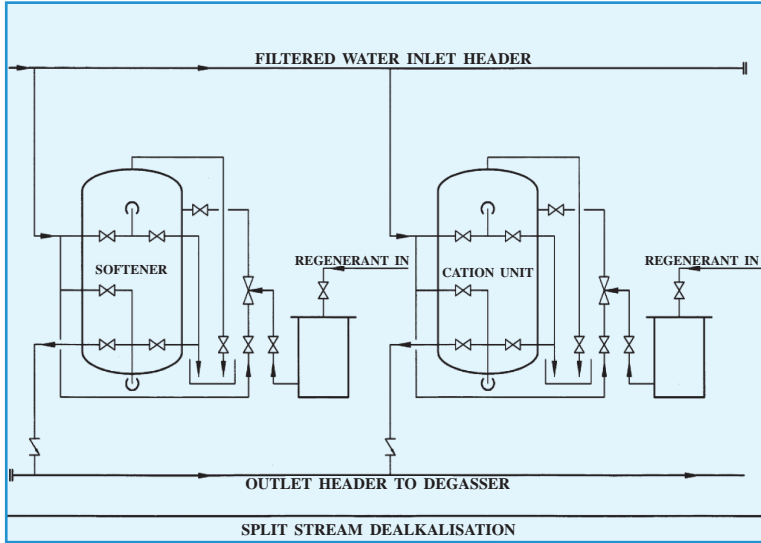

### I. Service cycle

#### a) Softener

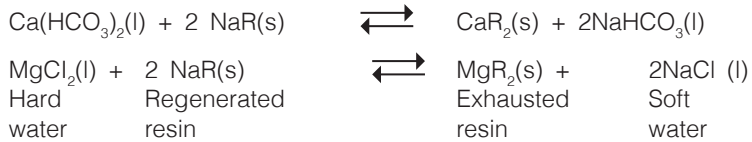

#### b) HI unit

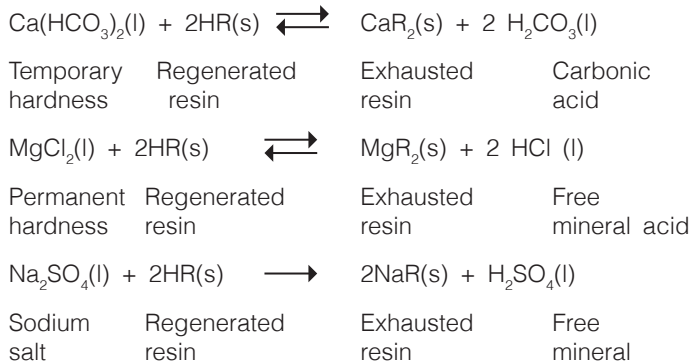

**c) Blending of effluent from softener and HI unit**

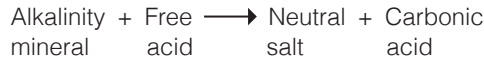

Carbonic acid is unstable and dissociates to carbon dioxide.

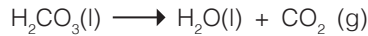

The carbon dioxide is stripped in an atmospheric degasser.

**II. Regeneration cycle**

**a) Softener**



**b) HI unit**

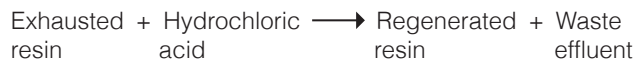

**B) Dealkalisation with Weak Acid Cation (WAC) Resin**

**a) Service**



**b) Regeneration**

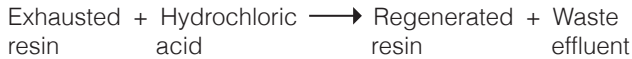

**C) Combination of WAC and Softener**

The WAC resin reacts with alkaline salts only and not with neutral salts in water.

The combination of WAC and softener is therefore used when permanent hardness is present in water.

The WAC efficiently removes the temporary hardness and the downstream softener exchanges the permanent hardness.

**Regeneration steps**

Regeneration steps include:

- Backwash to remove any dirt on top of the column and to loosen the bed
- Injection of dilute hydrochloric or sulphuric acid to regenerate the resin. If sulphuric acid is used it must be injected as a very dilute acid with concentration less than 0.8% w/v
- Fast rinse to remove the acid remaining in the column
- Dealkalised water is used as boiler feed and as cooling tower makeup

**6.3.3. De-silicisation**

The process is used in select cases of boiler feed where water has low TDS and silica limits the blowdown. Soft water is passed through a strong base resin in hydroxide form which removes silica.

On exhaustion the resin is regenerated with a dilute solution of caustic soda. Prior softening is required to prevent precipitation of hardness on the strong base resin.

**Service cycle**

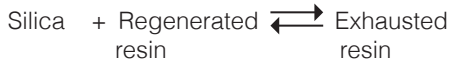

**Regeneration cycle**

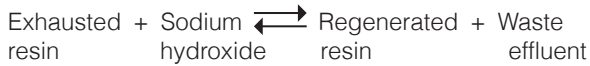

**6.3.4 Demineralisation**

The process removes dissolved solids present in water. Following variations are possible:

1. SAC → SBA
2. SAC → SBA → MB
3. SAC → Degasser → SBA
4. SAC → Degasser → SBA → MB
5. SAC → Degasser → SBA → CATPOL
6. WAC/SAC → Degasser → WBA/SBA
7. WAC/SBA → Degasser → WBA/SBA → MB

Water contains both alkaline and neutral salts. A strong acid cation exchanger splits both types of salts - alkaline salts are converted into carbonic acid ( $\text{H}_2\text{CO}_3$ ) and the neutral salts into corresponding mineral acids.

Carbonic acid is a weak acid and is easily removed in a degasser by simply blowing air through a packed column filled with plastic pall rings.

The mineral acids are neutralised by the strong base anion exchanger producing water practically free from dissolved salts. Silica and residual carbon dioxide are removed by the strong base resin.

The only impurity now present in the demineralised water is a few ppm of hydroxide alkalinity and traces of silica which are removed in the mixed bed. Alternatively the hydroxide alkalinity may be removed in a strong acid cation unit called CATPOL (Cation Polisher). The unit does not remove the residual silica.



### **Concept of sodium slip**

During the regeneration process, the cation resin is expected to remove calcium, magnesium and sodium completely. While calcium and magnesium are removed completely, sodium is not completely removed. During the next service cycle a few ppm of sodium find their way into the treated water. This gets converted into caustic soda. This phenomenon is called sodium slip and it gives rise to high conductivity and high pH of treated water from following anion unit.

The cation resin has higher affinity for bivalent ions and has almost equal affinity for hydrogen and sodium ions. During the regeneration process, the strength of the acid reaching the bottom layer gets reduced and the acid is also contaminated with the ions removed from the top layers acid. Hence, complete regeneration does not take place and some sodium ions are left behind.

During the subsequent service cycle acids generated in the upper layers of the unit have a regenerating effect. Therefore, some sodium remaining in the bottom layer gets eluted resulting in sodium slip.

Each ppm of sodium as  $\text{CaCO}_3$  coming out as NaOH from the following SBA unit gives rise to a conductivity of  $5 \mu\text{S/cm}$ . Hence, it is important to control the sodium slip to improve treated water quality.

Sodium slip is a function of the regeneration level and equivalent mineral acidity (EMA). The higher the regeneration level, the lower is the sodium slip and higher the EMA higher is the sodium slip. Increasing the regeneration level increases the operating cost.

The cost of producing demineralised water can be minimised by improving the regeneration efficiency of the process.

### **Concept of regeneration efficiency**

Efficiency of a process is defined as the ratio of output/input expressed as a percentage. In ion exchange processes output is the work done by the resin or amount of ions removed which is equal to the product of throughput and ionic load expressed as  $\text{CaCO}_3$ .

Input is the quantity of regenerant used also expressed as  $\text{CaCO}_3$  (typical efficiency of a co-flow process will be in the region of 60 to 70 %).

One of the methods to improve regeneration efficiency is to design the ion exchange units for counter current (CCR) regeneration. It helps to choose a lower regeneration level which marginally increases the resin quantity but greatly reduces the regenerant quantity used.

**Counter current regeneration (CCR)** – In a counter current regenerated unit, service flow is in one direction, say from top to bottom while the flow of regenerant as well as flow of subsequent rinse is in the opposite direction i.e from bottom to top. The advantages of the process are:

1. Sodium slip from the unit is minimised to less than 1 mg/l throughout the run which in turn improves the treated water quality substantially.
2. The quality of treated water will not deteriorate even if the influent quality deteriorates subsequently in terms of EMA.
3. The process improves the overall efficiency of regeneration and results in lower operating cost. Regeneration level employed for a CCR unit can be lower than that used for co-flow regeneration resulting in lower operating cost. The regenerant is fully utilised with the result that chemical required for neutralisation is also minimised.

Sodium slip is minimised by maintaining a bottom layer of resin in a highly regenerated condition throughout the run. Any sodium slip eluted from the top layer is taken up by the bottom layer of resin which essentially prevents sodium slip from the unit.

Following conditions must however be fulfilled for successful operation of a counter current operation:

1. The middle collector located at the top of the unit should be buried in 150 mm layer of resin.
2. A downflow of either air or water should be maintained to prevent fluidisation during regeneration and subsequent rinse steps.
3. Product water should be utilised for dilution of regenerant as well as for subsequent rinsing.
4. Full backwash of the unit should not be carried out prior to every regeneration, instead only flushing of top collector should be carried out.

The other method is to use a combination of weak and strong resins. A weak acid cation resin will remove alkaline hardness with almost 100% efficiency. The overall efficiency of the system can be improved close to 90%. Similarly, the weak base resins have high regeneration efficiency and the overall regeneration efficiency of a combination of WBA followed by SBA units can be as high as 90%.

**Methods of regeneration include:**

Co-flow regeneration in which the service flow and regenerant flows are in the same direction.

Counter current regeneration in which the service flow and the regenerant flows are in the opposite direction.

Thoroughfare regeneration is applicable for the WAC/SAC combination of units and WBA/SBA combination. For example, the regenerant first enters SAC and the unutilised regenerant is then used to regenerate the WAC unit.

Mixed bed regeneration – mixed bed can be regenerated either sequentially or simultaneously.

**Flow diagram of co-flow unit – service**

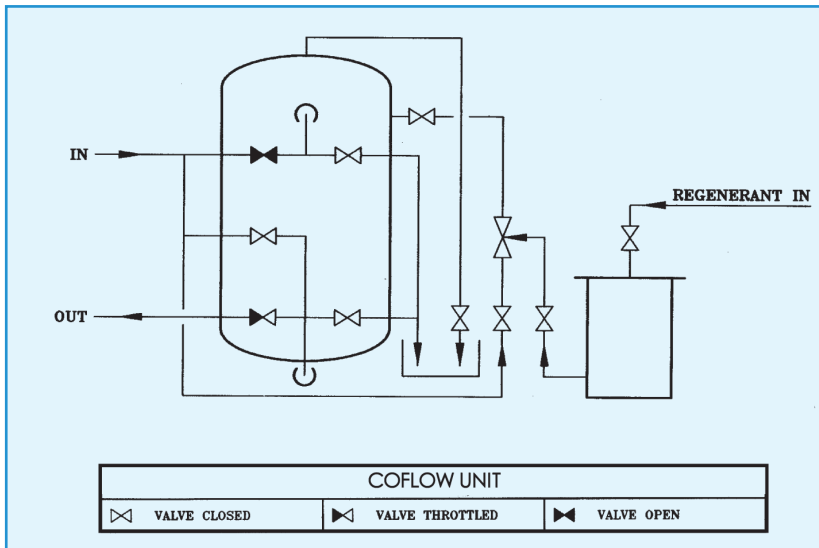

Co-flow regeneration comprises the following basic steps:

- Backwash
- Regenerant injection
- Rinse

The rinse step may include a slow rinse followed by the final rinse.

### Flow diagram of counter flow unit – service

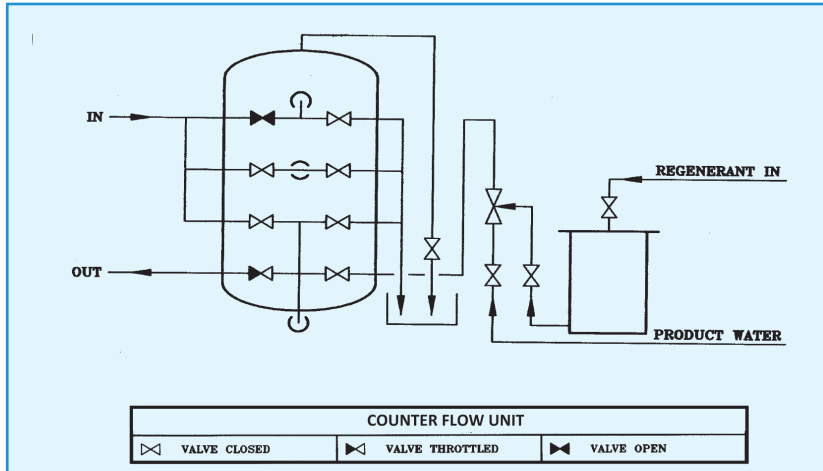

Counter flow regeneration comprises the following basic steps:

- Middle collector flush (unit is fully backwashed only when the pressure drop across the unit exceeds the set limit)
- Regenerant injection. During this step a down flow of water or air is maintained from the top to prevent fluidisation. This down flow of air and water exits through the middle collector
- Regenerant rinse. Downflow of water or air is maintained during this step as well
- Final rinse

### Mixed Bed (MB)

A mixed bed unit is essentially consists of a mixture of strong acid cation resin in hydrogen form and strong base anion unit in hydroxyl form. The unit produces good quality water as each cation unit is adjacent to the anion unit. Acid produced by the cation resin is immediately neutralised by the anion resin and hence, the slip is greatly reduced and hence, both sodium and silica slips are reduced. Once the bed is exhausted, the unit can be regenerated either sequentially or by simultaneous mode of regeneration.

Mixed bed regeneration comprises the following basic steps:

- Backwash
- Regenerant injection
- Regenerant rinse
- Air mix
- Final rinse

Mixed beds can be regenerated by sequential regeneration or by simultaneous regeneration.

### Flow diagram of MB sequential – service

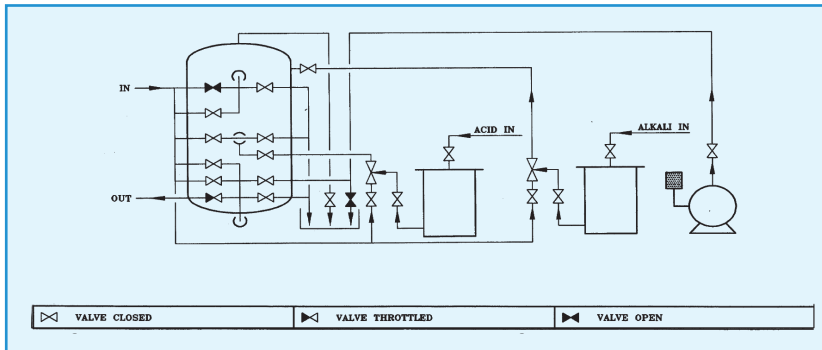

Regeneration of mixed bed unit – sequential regeneration

1. Separation of resin by backwashing with water. Anion resins are lighter as compared to cation resin. Backwash with water separates the resin in two bed anion resin sitting on top of the cation resin.
2. Injecting acid through the middle collector which flows downwards, regenerates the cation resin and flows out through the bottom collector. During this process downflow of water is kept from the top which prevents acid coming in contact with the anion resin.
3. The cation resin is then rinsed with water to remove the excess regenerant.
4. Anion resin is regenerated with alkali which flows from top through the anion resin and flows out of the middle collector. During this process an upflow of water is maintained to prevent alkali coming into contact with the cation resin. The anion unit is subsequently rinsed with water.
5. Both the resins are now intimately mixed with air using a dedicated air blower.
6. Immediately following the air mix operation, the unit is rinsed downward using the feed water till the desired conductivity is reached.

### Flow diagram of MB - simultaneous - service cycle

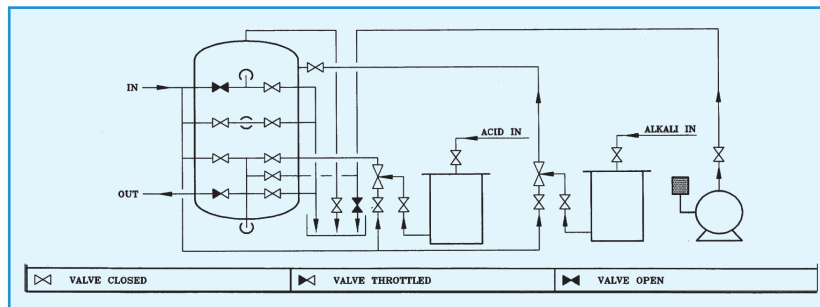

### Regeneration of mixed bed unit – simultaneous regeneration

1. Separation of resin by backwashing the unit.
2. Regenerating the anion unit with alkali and the cation unit with acid simultaneously. Alkali flows from top of the unit and is removed through the middle collector, while the acid is injected from the bottom of the unit is collected through the middle collector. It is important to maintain the flow rate equally during this process. The units are subsequently rinsed with water in the same way. The resin are intimately mixed using compressor air and rinsed with water till conductivity is obtained.

### Quality of water produced

The ion exchange process produces water of very high purity suitable for high pressure boilers. Treated water conductivity @ 25° C is less than 0.2  $\mu\text{S}/\text{cm}$  and reactive silica less than 20 ppb. The pH is expected to be between 6.8 - 7.2.

Measuring pH of MB treated water is very often difficult as the water has no electrolytes. It can be measured by specially designed on-line analysers using flow through measuring cells of SS construction which can be earthed.

Modern high pressure boiler operations call for removal of non-reactive or colloidal silica as well. Installing an ultra filtration system after the mixed bed polisher will remove colloidal silica almost completely.

In case the feed water has TDS greater than 600 mg/l, it may be economical to use a combination of RO and MB units.

### Guidelines for troubleshooting and maintenance of ion exchange unit

Procedure for troubleshooting and maintenance of ion exchange units are given in Annexure-5.



# Chapter 07

## MEMBRANE PROCESSES

**Gelatin concentration at a food and beverage plant**



**Membrane application at an automotive industry**



**Brackish water reverse osmosis unit at a power plant**



**Sea water reverse osmosis at a power plant**







## 7.0 MEMBRANE PROCESSES

### 7.1 An Overview

Membrane processes involve the use of a semi-permeable membrane which selectively allows one species of molecules to permeate through and retains the rest. For example an RO membrane allows water molecules to permeate through and rejects all other components including salts microorganisms and high molecular weight organics.

Membrane processes are now extensively employed in applications like desalination of sea water and brackish water, production of high purity water for pharma and semi-conductor industries, removal of colloidal silica from high pressure boiler feed water and in treatment of industrial effluents, to name a few.

Depending upon the membrane element used, the processes are broadly classified as:

- Micro filtration
- Ultra filtration
- Nano filtration and
- Reverse osmosis

The membrane elements are commercially available in different configurations like tubular, spiral wound, plate and frame, and hollow fibre. The selection will depend on the application. Spiral wound RO membranes are widely used for desalination of water. Hollow fibre ultra filtration membranes are used for removal of particulate matter/undissolved impurities. Plate and frame membranes are used mostly in effluent treatment like removal of indigo dye used in denim manufacture.

Effective pretreatment of feed water is essential to protect the membranes from foulants like suspended solids and colloidal particles.

Micro filtration and ultra filtration membranes do not require elaborate pretreatment. Granular media filtration followed by a 100 micron strainer may be adequate in most of the cases.

Nano filtration and RO membranes are invariably used in spiral wound configuration and are prone to severe fouling by colloidal particles. Hence, they require elaborate pretreatment especially if the raw water source happens to be a surface water source, namely coagulation,

flocculation, clarification and filtration through a granular media filter. In addition a micron cartridge is placed ahead of the membrane.

Plants using ground water sources may not require elaborate pretreatment. Granular media filtration followed by a micron cartridge filter may be sufficient.

Ultra filtration however can be used as pretreatment for the RO membrane. It enhances the useful life of the RO membrane; it will also minimise the frequency of replacement of micron cartridge filters.

**Filtration spectrum**

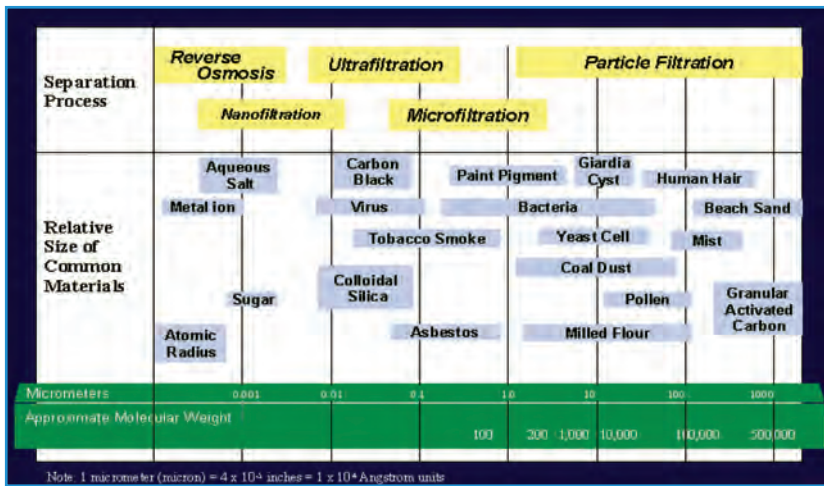
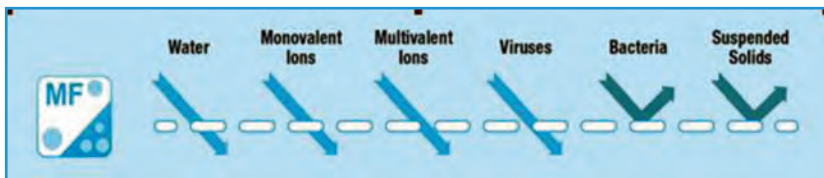

Fig 7.1 - Filtration spectrum

**7.1.1 Micro filtration (MF)**



Micro filtration (MF) is a cross flow pressure driven process which removes most of the undissolved impurities like suspended particles, impurities and bacteria with typical pore size of 0.1 micron. The membrane does not remove dissolved impurities. Removal of viruses is only partial.

Micro filtration can be implemented in many different water treatment processes requiring removal of turbidity and bacteria and produces crystal clear water.

### Applications in water treatment

Perhaps the most prominent application of micro filtration membranes is in the treatment of potable water supplies. The use of micro filtration membranes presents a physical means of separation (a barrier) as opposed to a chemical alternative. In this sense, both filtration and disinfection take place in a single step, negating the extra cost of chemical dosage and the corresponding equipment (needed for handling and storage).

#### 7.1.2 Ultra filtration (UF)

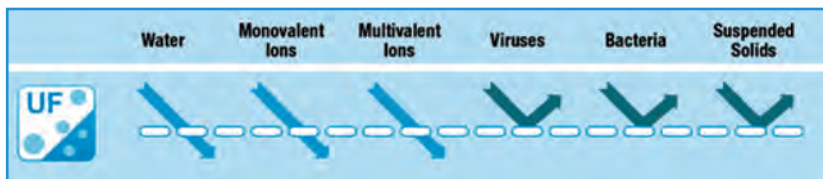

Ultra filtration (UF) is a cross flow low pressure driven process and involves the use of a semi-permeable membrane that separates particles on the basis of their molecular size.

Membranes are available with the following ratings (MWCO)

5,000(5K), 10,000(10K), 30,000(30K), 100,000(100K) and 500,000(500K).

Ultra filtration removes most of the undissolved impurities like suspended particles, colloidal impurities, proteins, bacteria and viruses. It reduces Total Organic Carbon (TOC), colour components and lowers Silt Density Index (SDI). It does not remove dissolved solids, sugar, alcohol and other low molecular weight organic compounds like glycerine.

Polysulphone and its derivatives like polyether sulphone are the widely used material for ultra filtration. These materials can tolerate pH between 1 and 13 and temperatures upto 45° C and have a high tolerance for free chlorine. The membranes can be cleaned with dilute NaOCl solution.

Ultra filtration membranes are available with the following configurations

- Plate and frame
- Tubular
- Hollow fibre and
- Spiral wound

Examples of ultra filtration applications are:

- Cold sterilisation of beverages and pharmaceuticals
- Clearing of fruit juice, wines and beer
- Separation of bacteria from water (biological waste water treatment)
- Effluent treatment
- Separation of oil/water emulsions
- Pretreatment of water for nano filtration or reverse osmosis
- Solid-liquid separation for pharmacies or food industries

Membranes in hollow fibre configuration are widely used in water treatment.

Besides polymeric materials, ceramic tubular membranes are being applied since these are tolerant to extreme pH, temperature and pressure. Even though these are for more expensive, these offer high flux rates.

The main applications in water treatment include the following:

- Bottled water production to produce sparkling water and for disinfection
- Removal of colloidal silica from feed to high pressure boiler feed water
- Pretreatment of RO feed water
- Production of pyrogen free water used in production of IV fluids
- Ultra pure water in the electronics industry

Other applications:

- a) Recovery of antibiotics proteins, polymers, starches, natural gums, enzymes, etc. in pharma, food and beverage industries
- b) Clays, pigments, minerals, latex particles, and microorganisms
- c) Oily water separation in metal working, steel, automobile and oil & gas industries

### 7.1.3 Nano filtration

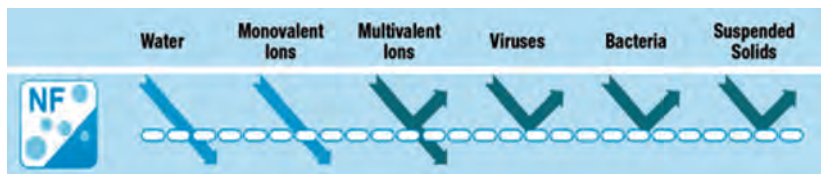

Nano filtration is a cross-flow pressure driven process. It removes all suspended and colloidal particles, bacteria, viruses and multivalent ions such as calcium, magnesium and sulphates and colour components. It does not remove monovalent ions.

Since it removes hardness efficiently at lower operating pressures than RO, NF membranes are sometimes called as “softening membranes”.

Nano filtration membranes are available commercially in tubular and spiral wound membranes. In spiral wound configuration, the equipment features the same proven hardware and components used in RO systems. Nano filtration membranes are used for pretreating feed water to thermal desalination plants (for removal of hardness).

Other applications include:

- Recovery and reuse of strong base or strong acid
- Recovery of caustic soda from CIP streams of dairy and citrus juice in food industry
- Desalting of dyes and pigments
- Whey protein concentration in dairy industry
- Concentration and desalting of pharmaceuticals and fine chemicals

#### 7.1.4 Reverse osmosis (RO)

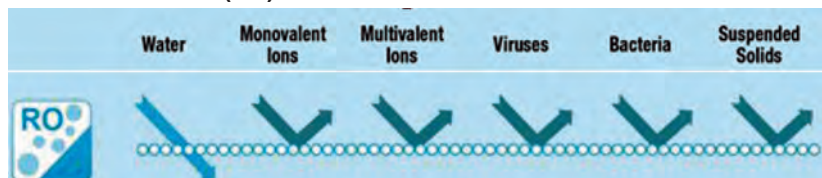

Reverse osmosis (RO) is a cross-flow high pressure process that involves the use of a semi-permeable membrane that removes both undissolved and dissolved impurities. Due to imperfection of membrane surface, some monovalent ions may permeate.

The process is extensively used to desalinate sea water as well as brackish water. RO followed by demineralisation is cost effective in a large number of cases especially where feed water TDS is moderately high.

Ultra filtration and reverse osmosis processes are dealt with in greater detail in the following paragraphs.

## 7.2 Ultra Filtration (UF)

Ultra filtration (UF) is a cross-flow low pressure driven process. It involves the use of a semi-permeable membrane that separates particles on the basis of their molecular size.

### 7.2.1 Applications of UF in water treatment:

#### 7.2.1.1 Removal of non reactive (colloidal) silica in feed to high pressure boiler feed water

Surface waters may contain colloidal silica during parts of the year.

The DM plant removes only reactive or soluble silica and does not remove colloidal silica. Colloidal silica gets converted into reactive silica and increases the silica content in the boiler drum. In order to meet limits for silica in the boiler, excessive blowdown has to be resorted to. Hence, it is necessary to remove both forms of silica from feed to high pressure boilers. UF is the only process that is proven to remove colloidal silica almost completely.

The UF membrane system is typically installed after the MB polisher. However, it can also be placed ahead of the DM plant. In this case, it will additionally protect the ion exchange resins from getting fouled by colloidal organic matter present in surface waters. If placed ahead of the DM plant, the membrane will require more frequent cleaning.

For removal of colloidal silica, membrane having MWCO 10,000 is selected.

#### 7.2.1.2 RO pretreatment

RO membranes are prone to severe fouling by colloidal particles like finely divided particles of sand, clay etc. present in feed water. UF removes these foulants very effectively and in addition removes the residual microorganisms, if any. It reduces the SDI significantly and reduces the frequency of replacement of micron cartridge filters.

Hence, UF is used to pre-treat waters suspected of having colloidal impurities. For RO pretreatment, membrane selected is 100,000 MWCO.

#### 7.2.1.3 Production of IV fluids

Production of IV fluids requires high purity water free from bacteria, viruses and pyrogens (these are dead bacterial cells and produce fever when they come in direct contact with blood).

## 7.2.2 Typical operation of vertical UF membrane

Ultra filtration membranes are assembled in one of the two configurations:

- 1 In the vertical position with inlet and outlet headers.
- 2 In the horizontal position, two or more membranes connected in series and housed in a pressure vessel (usually 8" membranes similar to those used in RO applications). A number of such pressure vessels are connected in parallel.

### 7.2.2.1 Typical assembly of vertically connected membranes

Number of membranes (with housing as integral part connected in parallel):

- Feed from bottom nozzle
- Permeate outlet and back-flush inlet from the top port
- Reject during back-flush and chemically enhanced backwash (CEB) from top nozzle

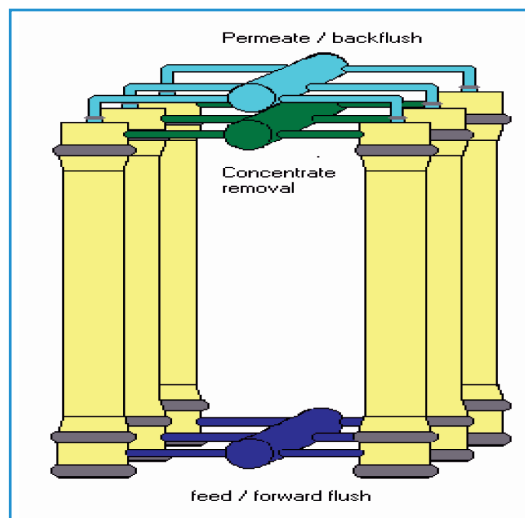

### 7.2.2.2 UF plant operation

A UF module resembles a shell and tube heat exchanger. The membranes are extruded into the shape of a pipe and fibres are bundled together and inserted into a pipe of PVC or polysulphon. Epoxy is injected into the pipe ends surrounding the outside diameter of all fibres. Feed water is pumped into the end of the pipe and travels through the ID of each fibre and collected in the pipe. Concentrated solids get accumulated in the fibre in a dead end filter and discharged.

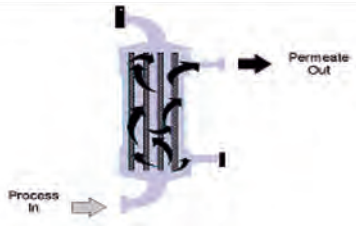
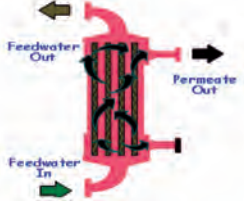
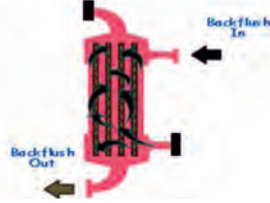
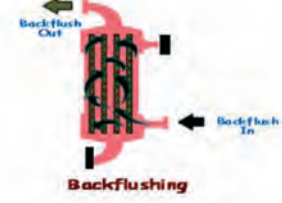
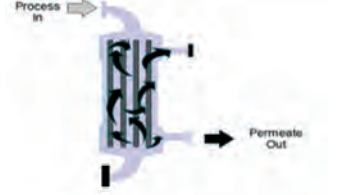

**Cross flow mode**

<p><b>Step - 1 Filtration – bottom feed</b> The feed enters the bottom inlet and is equally distributed to the membranes. Feed permeates to the outside and is collected and is removed through the permeate outlet fitted on the shell side. The reject stream passes through the tubes and flows out through the reject outlet at the top.</p>	
<p><b>Step - 2 Forward flush</b> This is part of the cleaning operation. Feed water enters through the inlet at the bottom and exits from the top outlet tube along with the debris. Permeate flows out through the port at side of the shell.</p>	
<p><b>Step - 3 Back flush – bottom exit</b> Backwash water enters through the port at to end of the shell and permeates through the outer side of the membrane and clears the debris and exits from the bottom outlet.</p>	
<p><b>Step - 4 Back flush – top exit</b> Back flush is continued with wash water now entering from the port at the bottom of the shell and exit through the top outlet.</p>	
<p><b>Step - 5 Resume filtration through top feed</b> Filtration cycle is now resumed with water entering from the top outlet. Water permeate through the membrane is collected from the bottom and exits through the port on the bottom side of the shell.</p>	

**Dead end mode**

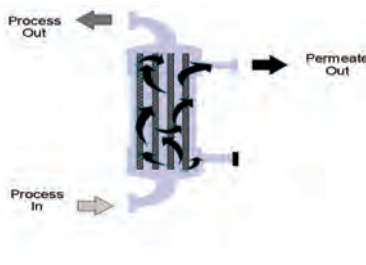
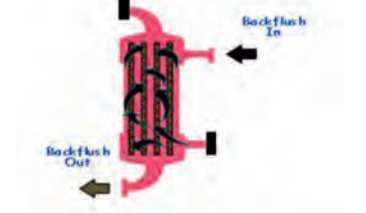
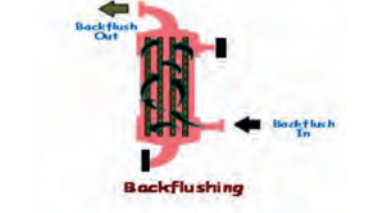
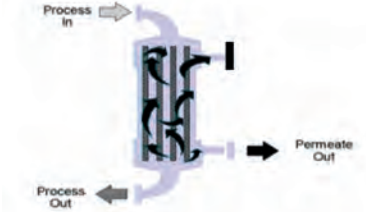
<p><b>Step - 1 Filtration – bottom feed</b></p> <p>The feed enters the bottom inlet and is equally distributed to the membranes. Feed permeates to the outside and is collected and removed through the permeate outlet fitted on the shell side. The reject stream passes through the tubes and flows out through the reject outlet at the top.</p>	
<p><b>Step - 2 Back flush – bottom exit</b></p> <p>Backwash water enters through the port at top end of the shell and permeates through the outer side of the membrane and clears the debris and exits from the bottom outlet.</p>	
<p><b>Step - 3 Back flush – top exit</b></p> <p>Back flush is continued with wash water now entering from the port at the bottom of the shell and exit through the top outlet.</p>	
<p><b>Step - 4 Resume filtration through top feed</b></p> <p>Filtration cycle is now resumed with water entering from the top outlet. Water permeate through the membrane is collected from the bottom and exits through the port on the bottom side of the shell.</p>	

### 7.2.2.3 Typical assembly



### 7.2.3 Assembly in horizontal position similar to housing of RO modules

Two or more membranes connected in series and housed in a pressure vessel (usually 8" membranes similar to those used in RO applications). A number of such pressure vessels are connected in parallel.

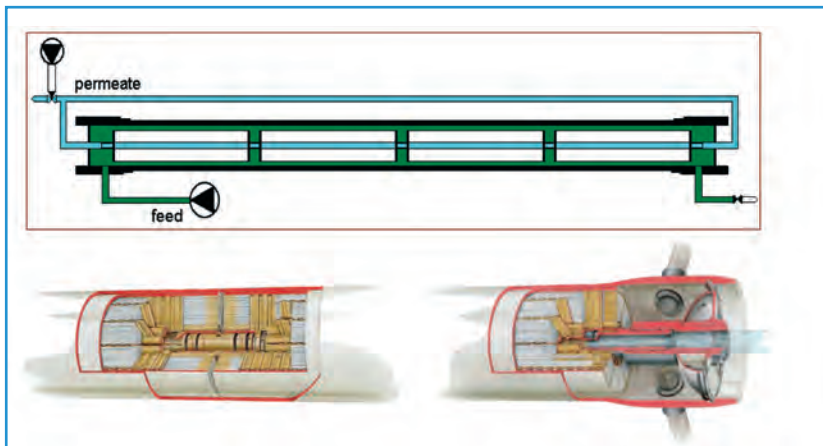



#### 7.2.4 Typical feed water limiting conditions for PES/PS hollow fibre membranes

Parameters	Value	Problem if the condition is exceeded
pH during operation	4 – 9	Membrane damage due to hydrolysis
pH during cleaning	2.5 – 12	Membrane damage due to hydrolysis
Chlorine tolerance during cleaning	2,00,000 ppm – hr for PES (5,00,000 ppm – hr for PVDF )	Membrane damage due to oxidation
Temperature	< 40° C for PES	Membrane damage
Oil & grease	< 5 ppm	Membrane fouling
Pressure	3.0 kg/cm <sup>2</sup> g for PES	

**Note :** Though there is no limit on turbidity, SS, organic matter, microbes and insoluble heavy metals, these are potential foulants.

### 7.2.5 Ultra filtration terminology

Feed	Input to ultra filtration system Feed Flow = Permeate Flow + Reject Flow
Permeate	The stream that passes through ultra filtration membrane
Reject	Waste stream from ultra filtration which carries the rejected impurities e.g. retained particles, colloids, bacteria, etc. at higher concentration than that of feed
Average trans membrane pressure	Difference in pressures between the permeate and the mean of the feed inlet and outlet pressures. Average trans membrane pressure = $(P_i + P_o)/2 - P$ Where P = Permeate pressure, $P_i$ = Inlet pressure, $P_o$ = Outlet pressure
Back flush	Permeate is pumped through the fibre in the reverse direction; it loosens and lifts off any material on the surface of the membrane
Forward flush	Opening of rejects valve and purging out solids accumulated with feed water before backflush operation in dead end filter
Gross flux	Rate at which product water flows through the membrane, usually expressed in gallons per square foot of membrane per day or gfd
% Recovery (R )	It is the ratio of permeate flow to feed flow. $= (\text{Permeate flow} / \text{Feed flow}) * 100$
Molecular weight cut off (MWCO)	Indicates lowest molecular weight of species that will be retained by the membrane

### 7.2.6 Trouble shooting of ultra filtration unit is given in Annexure-6

### 7.2.7 Operating modes

#### 7.2.7.1 Basic membrane concepts

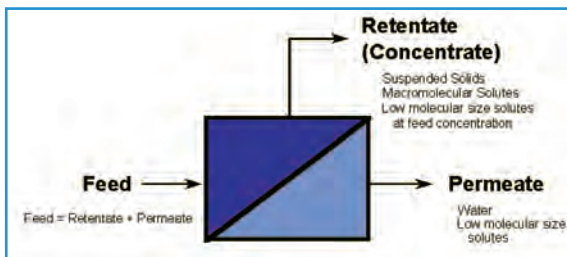

The feed is split into two streams - the permeate is the desired stream and contains all molecules of size less than the molecular weight cut off (MWCO) of the membrane used, and the retentate (concentrate) stream containing molecules higher than the MWCO of the membrane.

### 7.2.7.2 Batch process

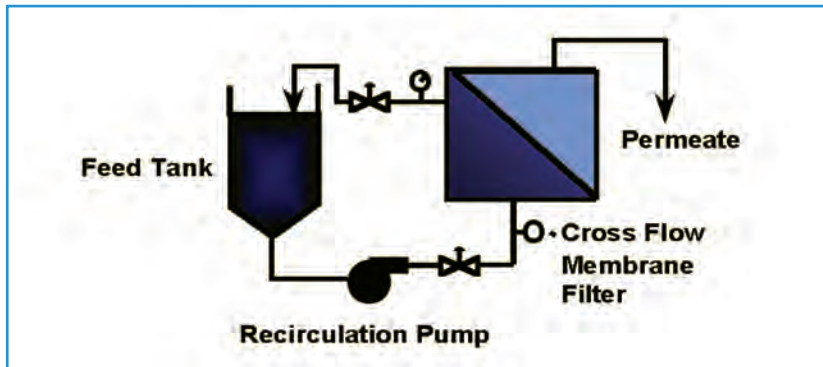

In the batch process, feed is re-circulated through the membrane filter. Permeate is collected separately and the concentrate is re-circulated.

### 7.2.7.3 Modified batch process

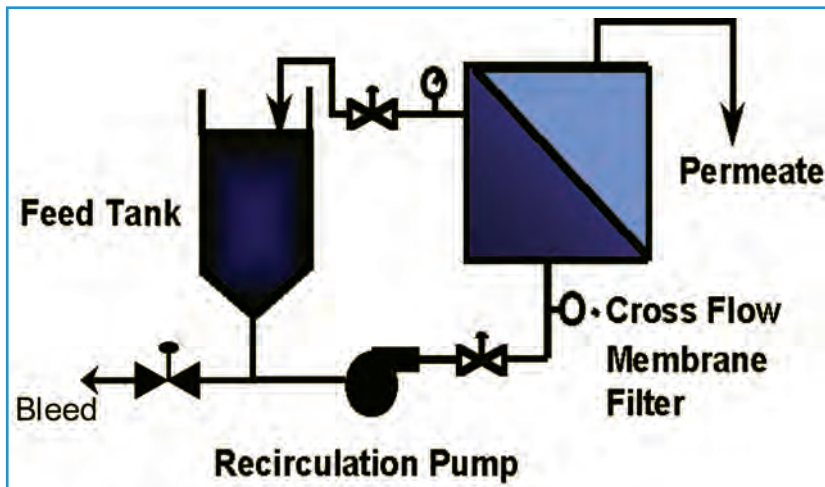

In the modified batch process, feed is continuously pumped into the process tank to maintain the level in the tank.

### 7.2.7.4 Feed and bleed process

In the feed and bleed process part of the re-circulated feed is bled off either in a continuous or intermittent process.

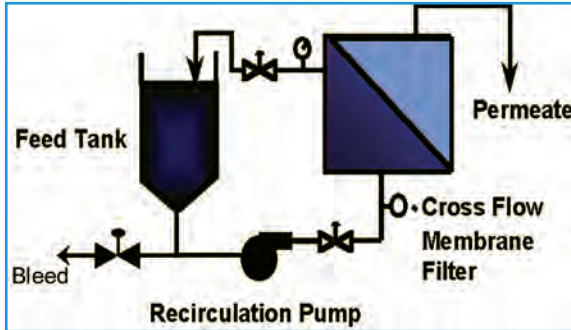

### 7.2.7.5 Cross-flow membrane filtration stages-in-series process

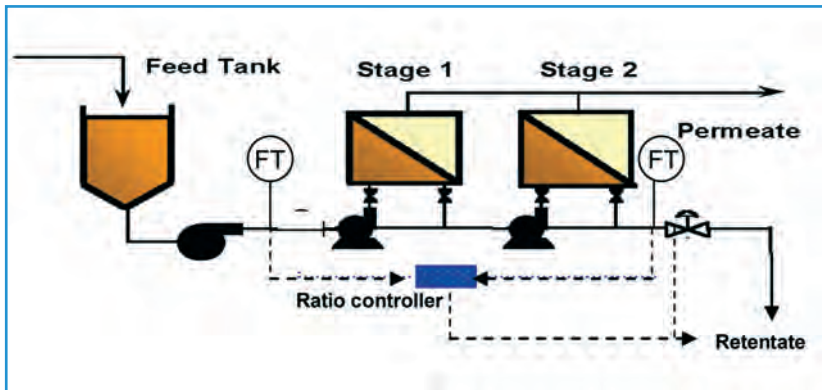

The concentrate is split into two streams. One stream is pumped through the first (previous) UF stage and the balance stream through the second (next) UF stage. The permeate streams are blended and collected. A flow ratio-controller measuring feed flow to the 1<sup>st</sup> stage and concentrate flow from the 2<sup>nd</sup> stage controls the operation.

The advantages are uniform quality in each stage and higher concentration factors.

## 7.2.8 Filtration cycle

Ultra filtration membranes are used either in cross-flow mode or in dead end mode.

### 7.2.8.1 Cross-flow filtration

The advantages include turbulent flow, continuous concentrate discharge and control of cake-layer build-up. The disadvantages are more complex layout, high energy consumption and high investment cost

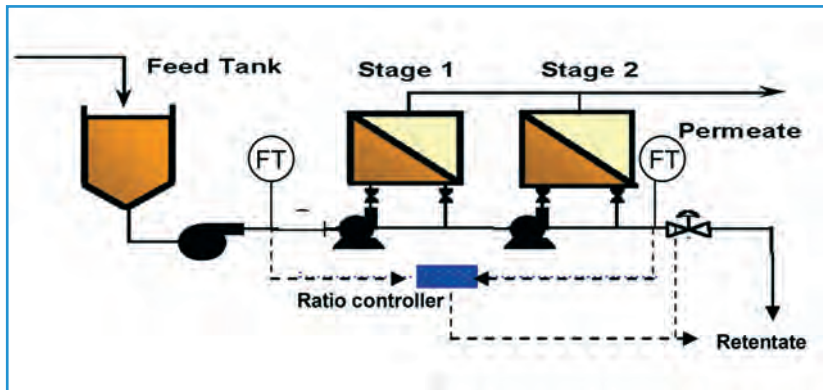

### 7.2.8.2 Dead end filtration

The advantages include simple process set-up, low energy consumption and low investment. Disadvantages are laminar flow, discontinuous concentrate discharge, risk of pore and membrane channel plugging and sensitivity changes in the feed properties.

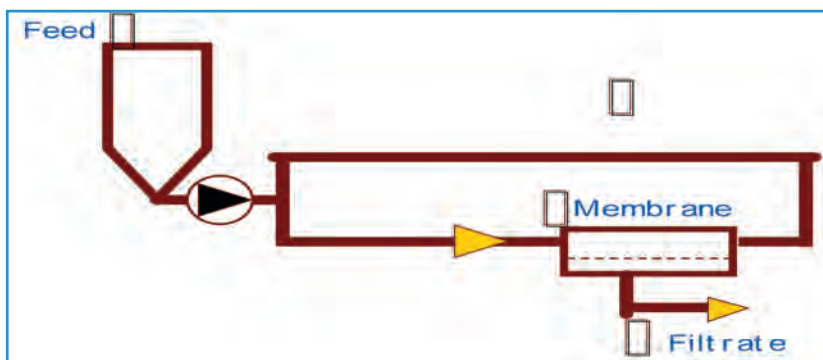

During normal operation, membranes do get fouled and the trans membrane pressure increases. At this point the membrane needs to be cleaned to restore the designed trans membrane pressure.



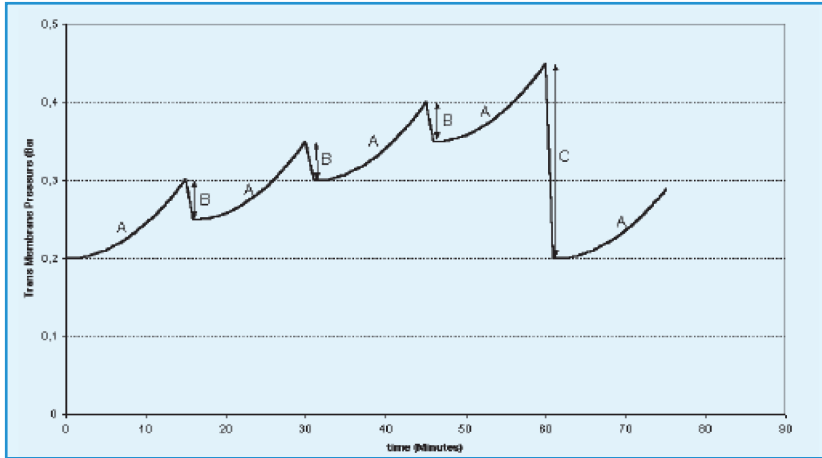

Curve – A represents increase in trans membrane pressure during filtration cycle

Curve – B represents reduction in trans membrane pressure during backflush operation

Curve – C represents drop in trans membrane pressure during Chemically Enhanced Backwash operation

### 7.3 Reverse Osmosis

Reverse osmosis (RO) is a cross-flow pressure driven process and employs a semi-permeable membrane (e.g thin film composite polyamide) that selectively allows water molecules to permeate and rejects all other species such as salts and large molecular weight organics.

Reverse osmosis removes both undissolved and dissolved impurities present in water. Polar molecules like ethanol, methanol and urea are only partly rejected. Low molecular weight organic compounds (typically less than 100 MW) are not rejected.

Major application of reverse osmosis is in water treatment for desalination of brackish and sea water.

RO membranes are commercially available in tubular, plate and frame, and spiral wound configurations. Desalination applications almost always use spiral wound membranes.

**A view of sea water desalination plant**



**7.3.1 Reverse osmosis operating principle**

Osmosis is a natural phenomenon and occurs when pure water flows from a dilute saline solution side through a semi-permeable membrane to the other side where a higher concentrated saline solution is present. For example, trees take up water from the ground where roots act as the semi-permeable membrane.

The phenomenon of osmosis is illustrated in the figure given below. A semi-permeable membrane is placed between two compartments. "Semi-permeable" means the membrane is permeable to some species and not permeable to others. Assume that this membrane is permeable to water but not to salt. Then place a salt solution in one compartment and pure water in the other compartment. The membrane will allow water to permeate through it to either side. But salt cannot pass through the membrane.

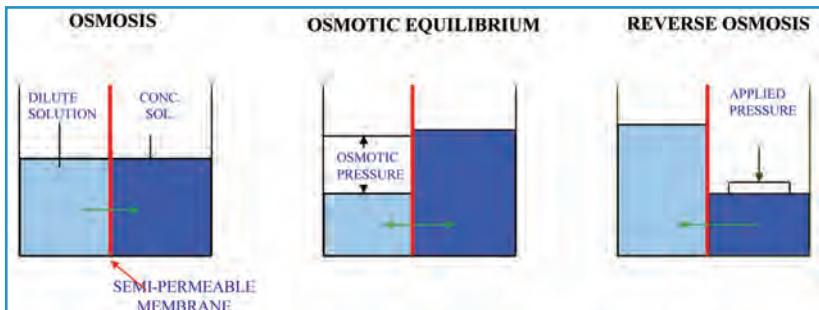

As a fundamental rule of nature, this system will try to reach equilibrium. That is, it will try to reach the same concentration on both sides of the

membrane. The only possible way for water to reach equilibrium is for water to pass from the pure water compartment to the salt containing compartment, to dilute the salt solution.

The figure above shows that osmosis can cause a rise in the height of the salt solution. This height will increase until the pressure of the column of water (salt solution) is so high that there is no net flow of water across the membrane. This is called as 'osmotic equilibrium'. The height of this water column at this point represents pressure against the membrane which is called osmotic pressure.

If pressure is now applied to this column of salt solution which is greater than osmotic pressure, the direction of water flow through the membrane can be reversed. This is the basis of the term 'reverse osmosis'. Note that this reversed flow produces pure water from the salt solution, since the membrane is not permeable to salt.

### 7.3.2 Schematic representation of typical reverse osmosis system

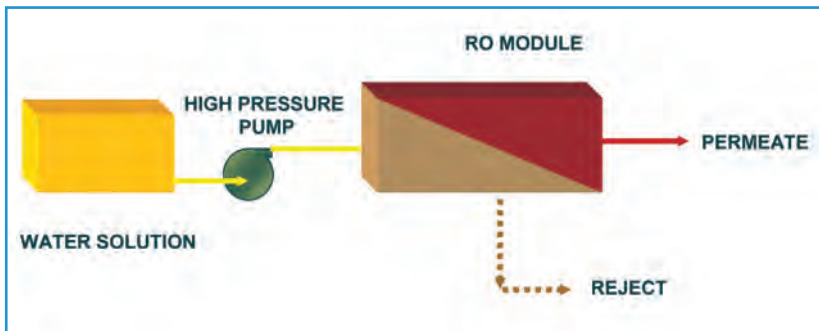

### 7.3.3 Terminology

#### 7.3.3.1 Recovery

Recovery is defined as ratio of permeate flow to the feed flow.

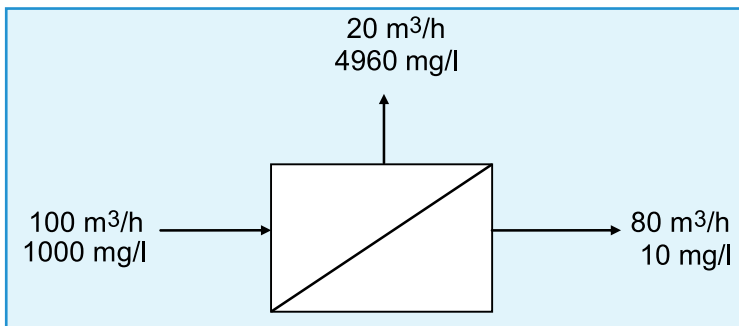

The water which passes through the membrane as useful product is called permeate. Remaining water, which does not pass through membrane and is discarded to drain with most of the salt from feed water, is called reject.

### 7.3.3.2 Salt passage

Theoretically, no salt should pass through an RO membrane. But no membrane is 100% perfect. Hence some salt does pass through imperfections on the membrane. Passage of this salt is quantified as follows:

$$\text{Salt passage} = \frac{\text{Permeate TDS}}{\text{Feed TDS}}$$

$$= 10/100 \text{ or } 0.01 \text{ or } 1\%$$

### 7.3.3.3 Salt rejection

Salt rejection is defined as

$$\text{Salt rejection \%} = (1 - \text{Salt passage}) \times 100$$

### 7.3.3.4 Net driving pressure (NDP)

This equals to the net pressure available to push the permeate across the membrane. Numerically it is given as

$$\text{NDP} = \text{Average Feed Pressure} - \text{Average Osmotic Pressure}$$

$$= \left[ \frac{(\text{Feed Pressure} + \text{Reject Pressure})}{2} - \text{Product Pressure} \right] -$$

$$\frac{(\text{Osmotic Pressure of Feed} + \text{Osmotic Pressure of Brine})}{2}$$

Thumb rule for calculating osmotic pressure of raw water or concentrate is: osmotic pressure (in psi) = Feed TDS x 0.01

E.g. a) Raw water having TDS = 1000 ppm, will have osmotic pressure of 10 psi

b) Sea water having TDS = 35,000 ppm, will have osmotic pressure of 350 psi (or 25 kg/cm<sup>2</sup>g)

### 7.3.3.5 Concentration factor

This equals to the factor by which concentration of salt increases in reject. It is defined as follows:

$$\text{Concentration Factor (CF)} = \frac{\text{Reject TDS}}{\text{Feed TDS}}$$

**Note:** While calculating the concentration factor as above, it is assumed that salt rejection is 100 %.

$$\text{Reject TDS} = \text{Feed TDS} \times \frac{1}{1 - R}$$

Where  $1/(1 - R)$  is concentration factor and R is recovery in fraction.

The following table shows reject TDS at various recoveries

Recovery %	Concentration factor	Feed TDS ppm	Reject TDS
50	2	1000	2000
60	2.5	1000	2500
75	4.0	1000	4000
80	5.0	1000	5000
85	6.67	1000	6670
90	10	1000	10000

When the recovery changes from 50% to 60%, the reject TDS increases by 500 ppm. But for the same % recovery change, i.e. 10% between 80% & 90%, the reject TDS increases by 5000 ppm.

This shows that a small change in recovery can lead to a large change in reject TDS when the plant is running at high recovery (i.e. more than 80%). Hence one should be very careful about maintaining proper recovery at higher range of recoveries.

### 7.3.3.6 Membrane flux

Membrane flux is defined as amount of water flowing through unit membrane area in unit time. The unit of flux is gfd i.e. gallons per square feet per day. Following are values of flux for various applications:

Waste water/sea water	=	8-10 gfd	
Surface waste (river/lake)	=	12-15 gfd	SDI<4
Bore well water	=	16-18 gfd	SDI<2

Using above values one can find out number of membranes required for the plant.

### 7.3.4 Concentration polarisation

In a reverse osmosis plant the separation between water and salt takes place on the membrane surface. Hence the concentration of salt is more on the membrane surface than the bulk stream. This phenomenon is called concentration polarisation. Due to concentration polarisation, membranes see higher solid concentration than their design. This leads to scaling and fouling of membranes. Hence concentration polarisation should be minimised. Following are ways to reduce concentration polarisation.

#### 7.3.4.1 Reduce membrane flux

Concentration polarisation occurs because separation between salt and water takes place on the membrane surface. Higher the separation, more the polarisation. In other words, if we reduce the flux of a membrane, separation at the surface reduces and polarisation decreases.

#### 7.3.4.2 Create turbulence

If enough turbulence is maintained at the membrane surface, salts on the surface will be conveyed back to the bulk stream and polarisation reduces. This is achieved by keeping a certain minimum brine flow from the membrane and using a feed/brine spacer which will induce turbulence on the membrane surface.

$\beta$  factor is a measure of concentration polarisation. For one of the membranes  $\beta$  factor for reject end membrane should be kept less than 1.2, while the value of  $\beta$  factor for other membranes is kept less than 1.13 (the difference in values is due to the different formulae used for calculation).

#### 7.3.4.3 Limiting flow through membranes

##### Maximum flow

If flow through a membrane exceeds recommended maximum flow, high-pressure drop occurs across membrane. This results in telescoping and mechanical damage of the membrane. Following are the maximum allowed flows, through a membrane.

Employing 28 mil thick feed/membrane spacers.

4" membrane = 3.6 m<sup>3</sup>/h

8" membrane = 17 m<sup>3</sup>/h

Since the maximum flow is at the feed of the first stage, maximum allowable feed flow to RO element can be calculated by using above value, e.g. for a plant using 8" membrane with an array of 2:1:1, maximum allowable feed flow =  $17 \times 2 = 34 \text{ m}^3/\text{h}$ .

### **Minimum flow**

A certain minimum flow of reject is required to be passed through a membrane in order to reduce concentration polarisation. Following are the minimum required reject flows through a membrane:

4" membrane =  $0.9 \text{ m}^3/\text{h}$

8" membrane =  $3.5 \text{ m}^3/\text{h}$

Since minimum reject flow is seen at the reject end of the last stage, by using above values the minimum reject flow required for a plant can be calculated.

E.g. for a plant using 8" membrane with an array of 20:11:6, minimum reject flow required =  $6 \times 3.5 = 27 \text{ m}^3/\text{h}$

### **Note:**

While operating a plant at flows or recovery other than its design, care should be taken to ensure that above limiting flow conditions are met.

## **7.3.5 Array**

An RO plant has modular construction i.e. it is made by arranging a number of RO membranes, which are the basic building blocks of a plant. This arrangement of membranes is called array. An array has the following building blocks:

### **7.3.5.1 Pressure tube**

A pressure tube houses from 1 upto 7 elements connected in series by an inter connector.

### **7.3.5.2 Staging**

A stage has a number of pressure tubes connected in parallel. All tubes receive feed from a feed header and the reject from all tubes is collected in a reject header. All pressures tubes under ideal conditions should produce equal product flow of the same salt concentration.

### **7.3.5.3 One or more stages in series make an array.**

### 7.3.6 Reject staging

Reject of one stage is feed to another stage. Single stage of an RO plant gives a maximum of 50% recovery. Hence, to maximise recovery further, reject staging is used (e.g. a two-stage RO plant can give maximum of 75% recovery while a three-stage RO plant can give a maximum of 87% recovery).

Following is an example of array representation employing reject staging:

Array: 4:2  
6 element long tube  
Membrane used

For example: an array 4:2 means 4 pressure tubes in 1<sup>st</sup> stage and 2 pressure tubes in second stage (see figure below).

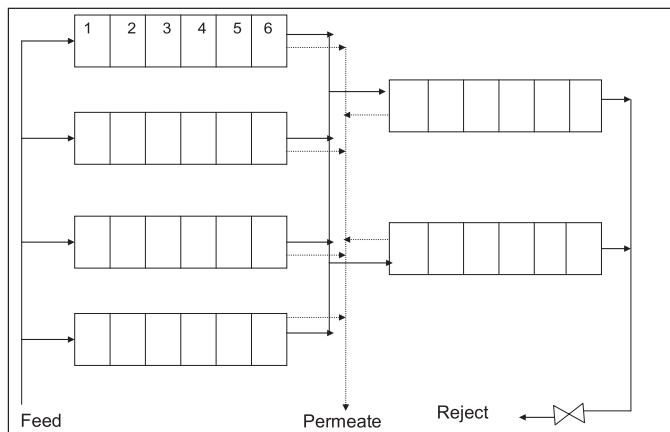

Reject staging

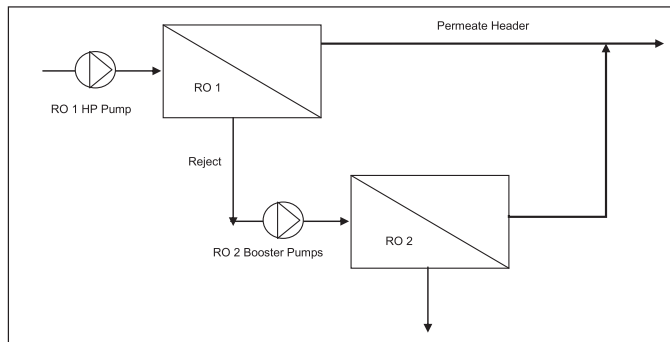

Reject staging with interstage booster



### 7.3.7 Permeate staging

Permeate of one stage (or plant) is feed to another stage (or plant). Permeate staging is typically done for an RO plant where raw water TDS is very high (e.g. sea water) and required TDS of the final product is low.

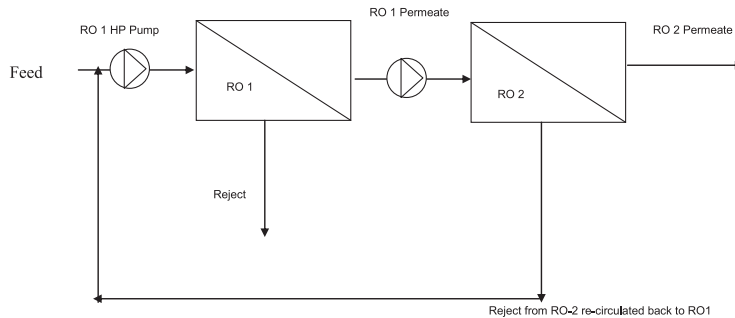

*Permeate staging*

### 7.3.8 Feed water limiting conditions

Every reverse osmosis membrane manufacturer lays down some limiting parameters for the feed water to the membranes. If the plant is operated outside the limits set by the manufacturer, the membrane guarantee becomes null and void. Such parameters are called feed water limiting conditions. These are discussed below.

The following conditions apply in general to most of the membranes.

#### pH

Membranes get hydrolysed at both high as well as low pH. Limiting range of pH is as follows:

Cellulose Acetate membrane	:	4-6
Polyamide membrane	:	3-11

#### Chlorine tolerance

Cellulose Acetate Blend (CAB) as well as Composite Polyamide (CPA) membranes are oxidised by chlorine. However, CAB membranes show some chlorine tolerance. Limiting values for free chlorine are

CAB membrane	:	1 ppm on continuous basis
CPA membrane	:	Nil

### **Turbidity**

Turbidity is a measure of haziness of the water. Fine colloidal matter in the water imparts turbidity to it. Turbidity is measured by passing a ray of light through water and measuring light scattered at 90° to the direction of the ray. The amount of light scattered depends on the quantity and type of colloids present.

It is to be noted that turbidity gives no idea about the amount of solids present and their nature. However, this is used to judge the quality of water quickly. Colloidal matter gets destabilised in the RO membrane and it precipitates over the membrane. This results in reduction of permeate flow and increase in pressure drop across the membrane.

Turbidity at the inlet of the membrane, for both CAB & CPA membranes, should be less than 1 NTU.

### **Suspended solids**

This is a quantitative measure of suspended matter in the water. Its unit is ppm or mg/l.

Suspended matter gets trapped into the feed/brine spacer. This causes an increase in RO feed pressure and pressure drop. Consequently, it results in a decrease in the RO permeate flow.

Suspended solids at the inlet of all membranes should be less than 1 ppm.

### **Silt Density Index (SDI)**

SDI is a measure of the fouling nature of RO feed water due to colloidal impurities. The fouling is due to the suspended matter present in the RO feed, which sits in the feed/brine spacer, and on the membrane surface.

Annexure-26 describes the procedure for finding SDI.

Maximum allowed value of SDI<sub>15</sub> (i.e. SDI obtained in a 15 minute test) at the membrane feed for all membranes is 4.0.

### **Organic matter**

Organic matter is measured in terms of BOD & COD. It causes the following problems for membranes:

- If organic matter is in dissolved state, but has a long chain structure and/or cationic charge on it, this will sit on the membrane and reduce the permeate flow

- If organic matter is in suspended form, it will sit in the feed/brine spacer causing high-pressure drop across the plant
- Bacteria grow on this organic matter forming slime on the membrane. This results in an increase in feed pressure and decrease in permeate flow

Organic matter at the membrane feed should be nil for all membranes. However, experience shows that organic matter up to 10-15 ppm in feed to RO membranes does not cause a serious fouling problem for the membranes. Hence, no pretreatment for organic matter is given in such a case. However, this results in frequent cleaning of the membranes.

### **Heavy metals (Fe, Mn)**

At high pH and in the presence of oxygen (air), these metals are oxidised to give hydroxide precipitates. This precipitate forms a scale over the membrane and permeate flow is reduced.

Maximum allowable heavy metals in feed to RO membranes for all membranes are 0.1 ppm.

### **Oil & grease**

Oil and grease get adsorbed on the membrane surface causing membrane fouling.

These should be totally removed from the RO feed water for all membranes.

### **Bacteria**

A single cell bacteria replicates every 20 minutes. At this rate a single cell of bacteria produces a enormous amount of bacteria in 24 hours. These bacteria form slime over the membrane, reducing its production.

No bacteria should be present in the feed to membranes.

## **7.3.9 Other important parameters**

Some sparingly soluble salts are present in the raw water. These salts may be completely soluble in raw water but may come out of solution when salt concentration increases towards the reject end. The following guidelines are laid down by membrane manufacturers to avoid scaling due to these salts. Since scaling starts first at the reject end, the parameters are observed and maintained for reject only.

### Langelier saturation index (LSI)

This index indicates scaling tendency due to calcium carbonate present in water. LSI of water is a function of calcium, alkalinity, TDS & temperature and pH.

Following are the possible cases of LSI values:

- LSI < 0: This indicates that  $\text{CaCO}_3$  is completely soluble in water. Hence it will not form a scale
- LSI = 0: This means  $\text{CaCO}_3$  has reached saturation. Any further drop of permeate removed will result in  $\text{CaCO}_3$  precipitation
- LSI > 0: This indicates that  $\text{CaCO}_3$  is already present in water in excess of its saturation limit. The water has already started precipitating  $\text{CaCO}_3$

When  $\text{CaCO}_3$  precipitates over the membrane, it reduces permeate flow. The crystals of  $\text{CaCO}_3$  may also physically damage the membranes.

It is desirable that LSI should be kept negative in the reject for the RO plant. However, with the help of some specialty chemicals called antiscalants, the plant can be operated even with positive LSI at reject. Following are the permissible values of LSI for reject:

LSI < -0.2	No antiscalant dosing is required
LSI < +2.5	With specialty antiscalants

### Sulphates

Sulphates of calcium, barium and strontium are sparingly soluble in water. However, we will discuss  $\text{CaSO}_4$  only, as  $\text{BaSO}_4$  and  $\text{SrSO}_4$  are not found in Indian waters.

Calcium sulphate can form scales at the reject end of the plant, which reduces permeate flow.

%  $\text{CaSO}_4$  at the reject for membranes should be less than 100%. However, with addition of Sodium Hexa Meta Phosphate (SHMP) or other antiscalant,  $\text{CaSO}_4$  up to 230% of  $K_{sp}$  (solubility product) is allowed in reject.

### Silica

Typically solubility of silica in raw water is considered as 100 ppm and at 25° C though it is influenced by pH as well. When silica is present in water above its saturation value, it polymerises to form needle-like

crystals. Silica also combines with heavy metals present in water to produce hard silicate compounds. Scale formed by silica is hard and it is insoluble in most chemicals. The scale reduces permeate flow of the plant. Maximum allowable silica saturation in the reject is less than 100%. However, some super saturation is allowed when a specialty antiscalant is used. (Maximum permissible value of silica in RO reject with the help of specialty antiscalant is 300 ppm)

In order to design an RO plant, which meets all limiting conditions laid down by the manufacturer and other parameters like LSI, some basic data is required. This data is provided by analysis of raw water.

It is to be noted that if there is more than one raw water source for the RO plant, analysis should be carried out for all such sources.

### **7.3.10 RO membrane fouling and cleaning**

During normal operation over a period of time, RO membrane elements are subject to fouling by suspended or sparingly soluble materials that may be present in the feed water. Common examples of foulants are:

- Calcium carbonate scale
- Sulphate scale of calcium, barium or strontium
- Metal oxides (iron, manganese, copper, nickel, aluminum, etc.)
- Polymerised silica scale
- Inorganic colloidal deposits
- Mixed inorganic/organic colloidal deposits
- NOM organic material (Natural Organic Matter)
- Man-made organic material (e.g. antiscalant/dispersants, cationic polyelectrolytes)
- Microorganisms (bacterial bio-slime, algae, mould, or fungi)

The nature and rapidity of fouling depends on a number of factors, such as the quality of the feed water and the system recovery rate. Typically, fouling is progressive and, if not controlled early, will impair the RO membrane element performance in a relatively short time. Cleaning should occur when the RO shows evidence of fouling, just prior to a long-term shutdown, or as a matter of scheduled routine maintenance.

Fouling characteristics that signal the need for cleaning are:

- A 10 – 15% decrease in normalised permeate flow
- A 10 – 15% decrease in normalised permeate quantity

- A 10 – 15% increase in normalised pressure drop, as mentioned between the feed and concentrate headers
- In the event operating data is not normalised, the above values still apply if there are no major changes in critical operating parameters. The operating parameters that have to stay constant are permeate flow, permeate back pressure, recovery, temperature and feed TDS. If these operating parameters fluctuate, then it is highly recommended to normalise the data to determine if fouling is occurring or if the RO is actually operating normally based on the change in critical operating parameters

Monitoring the overall plant performance on a regular basis is an essential step in recognising when membrane elements are becoming fouled. Performance is affected progressively and in varying degrees, depending on the nature of the foulants. A troubleshooting matrix which provides a summary of the expected effects that common foulants have on performance is given in Annexure-6.

RO cleaning frequency due to fouling will vary by site. A rough rule of thumb for acceptable cleaning frequency is once every 3 to 12 months. If you have to clean more than once a month, you should be able to justify further capital expenditure for improved RO pretreatment or a re-design of the RO operation. If the cleaning frequency is every one to three months, you may want to focus on improving the operation of your existing equipment but further capital expenditure may be harder to justify.

It is important to clean the membranes when they are only lightly fouled, not wait for them to be heavily fouled. Heavy fouling can impair the effectiveness of the cleaning chemical by impeding the penetration of the chemical deep into the foulant and in the flushing of the foulant out of the element. If normalised membrane performance drops 30 to 50%, it may be impossible to fully restore the performance back to baseline conditions.

One RO design feature that is commonly overlooked for reducing RO cleaning frequency is the use of RO permeate water for flushing foulants from the system. Soaking the RO elements with permeate during stoppages can help dissolve scale and loosen precipitates, reducing the frequency for chemical cleaning.

Cleaning requirements can vary depending upon the type of foulant present.



# Chapter 08

## HIGH PURITY WATER SYSTEMS

**Condensate polishing units  
at a power plant**



**Reverse osmosis electrodeionisation for  
pharmaceutical & electronics industries**







## 8.0 HIGH PURITY WATER SYSTEMS

### 8.1 High Purity Water Systems for the Semiconductor Industry

Large quantities of water of very high purity are required in the manufacture of semiconductors.

The table below shows the changes in specifications in water quality based on improvements in the structure of integrated circuits.

Structure	1.5 $\mu\text{m}$	0.9 $\mu\text{m}$	0.7 $\mu\text{m}$	0.5 $\mu\text{m}$	0.35 $\mu\text{m}$	0.25 $\mu\text{m}$
DRAM	256 K	1 M	4 M	16 M	64 M	256 M
Resistivity, megohm-cm	17,7	17,8	18,0	18,2	18,2	18,24
TOC, ppb	100	50	10	5	1	0,5
SiO <sub>2</sub> , ppb	10	5	3	1	1	0,2
Ions, ppt	1000	1000	500	50	5	1
Oxygen, ppb		500	100	10	1	1
Particles > 1 $\mu\text{m}$ , 1/L	2.000					
Particles > 0,5 $\mu\text{m}$ , 1/L	10.000	2.500	100			
Particles > 0,2 $\mu\text{m}$ , 1/L		15.000	1.000	100		
Particles > 0,1 $\mu\text{m}$ , 1/L			5.000	500	100	
Particles > 0,05 $\mu\text{m}$ , 1/L				5.000	1.000	200
Particles > 0,03 $\mu\text{m}$ , 1/L						1000

#### Classification

Six types of electronic-grade water are described below. In all cases, the water quality recommendations apply at the point of distribution.

**Type E** — This water is classified as micro-electronic water to be used in the production of devices having line widths between 0 and 51  $\mu\text{m}$ .

**Type E - 1.1** — This water is classified as micro-electronic water to be used in the production of devices having line widths between 0.25 and 0.35  $\mu\text{m}$ .

**Type E - 1.2** — This water is classified as micro-electronic water to be used in the production of devices having line widths between 0.09 and 0.18  $\mu\text{m}$ . It is the water of ultimate practical purity produced in large volumes, and is intended for critical use.

**Type E - 2** — This water is classified as micro-electronic water to be used in the production of devices that have line width between 1 and 5  $\mu\text{m}$ .

**Type E - 3** — This grade of water is classified as macro-electronic water to be used in the production of devices having line width larger than 5  $\mu\text{m}$ . This grade may be used to produce larger components and some small components not affected by trace amounts of impurities.

**Type E - 4** — This grade may be classified as water used in preparation of plating solutions and for other applications where the water used can be of lesser quality.

Treatment scheme for the production of high purity water for the electronic industry

- Step 1** Pretreatment of water for removal of all undissolved impurities. Processes include chlorination, coagulation, flocculation, clarification and filtration through granular media filtration followed by micron cartridge filtration. The goal is to produce water of potable quality.
- Step 2** Desalination by reverse osmosis (RO) for removal of all ionic impurities.
- Step 3** Storage of RO permeate and ozonation to remove TOC and to sterilise the water.
- Step 4** Removal of dissolved oxygen and carbon dioxide in a vacuum degasser to reduce oxygen to less than 10 ppb and further reduction of oxygen to less than 1 ppb by catalytic oxidation process.
- Step 5** Demineralisation by treating the water through a mixed bed (MB) unit for reduction of residual ionic impurities. The MB unit should be regenerated externally to prevent accidental recontamination. At this stage conductivity of treated water will approach 18.2 Megohms.
- Step 6** Treatment through a second RO unit fitted with special membranes to further remove TOC and particulate matter.
- Step 7** Storage of high purity of water in SS tank with nitrogen blanketing to prevent ingress of air.
- Step 8** Downstream of the high purity water storage tank. Water enters a polishing loop and is subjected to UV (185 nm) for further reduction of TOC followed by MB to restore the conductivity. The polished water is kept recirculating on a continuous basis to prevent bacterial growth.

- Step 9** Treatment through an absolute micro filter followed by ultra filtration (UF) removes all particulate matter. At this stage all the treated water quality parameters – conductivity, TOC and particulate matter, are checked by online instruments.
- Step 10** Water now enters the point-of-use via a loop and is kept in recirculation all the time.

## 8.2 High Purity Water Systems for the Pharmaceutical Industry

Water is widely used in pharmaceutical industries as a raw material, ingredient and solvent in the processing, manufacture of pharmaceutical products, active pharmaceutical ingredients (API) and intermediates, compendia articles and reagents.

There are many different grades of water used for pharmaceutical purposes. These can be divided into two general groups - bulk waters which are produced and used at site, and packaged waters which are produced, packaged and sterilised to preserve microbial quality through their shelf life.

### 8.2.1 Purified water

Used primarily for production of non-parenteral preparations and for other purposes like cleaning of equipment and non-parenteral contact components. It is also used for all assays and tests. Purified water must meet the requirements for ionic and organic chemical purity and must be protected from microbial contamination.

The minimal source or feed water for production of purified water is drinking water.

### 8.2.2 Sterile purified water

Used in preparation of non-parenteral compendial dosages and analytical applications. It is packaged from purified water and rendered sterile.

### 8.2.3 Water for injection (WFI)

Used for preparation of parenteral preparations and other similar uses where product endotoxin content must be controlled.

### 8.2.4 Sterile water for injection

Water for injection packaged and rendered sterile used for sterile dilution of paranteral products.

### 8.2.5 Water for hemodialysis

Used for dilution of hemodialysis concentrate solutions. This grade of water is produced and used on site.

The prevailing water standards for pharmaceutical use are set forth by the United States Pharmacopoeia (USP).

The USP specifications require that “Water for Injection” (WFI) be produced only by distillation or reverse osmosis. “Purified Water” may be purified by distillation, reverse osmosis or ion exchange,

There is a clear distinction between purified water and water for injection (WFI). WFI must also meet bacterial endotoxin (pyrogen) specifications.

USP purified water has a number of pharmaceutical and cosmetic water applications, including higher volume uses such as container rinsing. WFI is used for the preparation of parenteral (injectable) solutions.

#### **United States Pharmacopoeia 30 standards (USP 30 Pharmaceutical Grade Water)**

Organics	<0.5 ppm TOC
Conductivity	<1.3 $\mu\text{S}/\text{cm}$ at 25° C in-line measurement
Endotoxin by LAL	
Purified Water	No specification
WFI	<0.25 EU/mL
Bacteria (guideline only)	
Purified Water	<100 cfu/mL
WFI	<10 cfu/100 mL

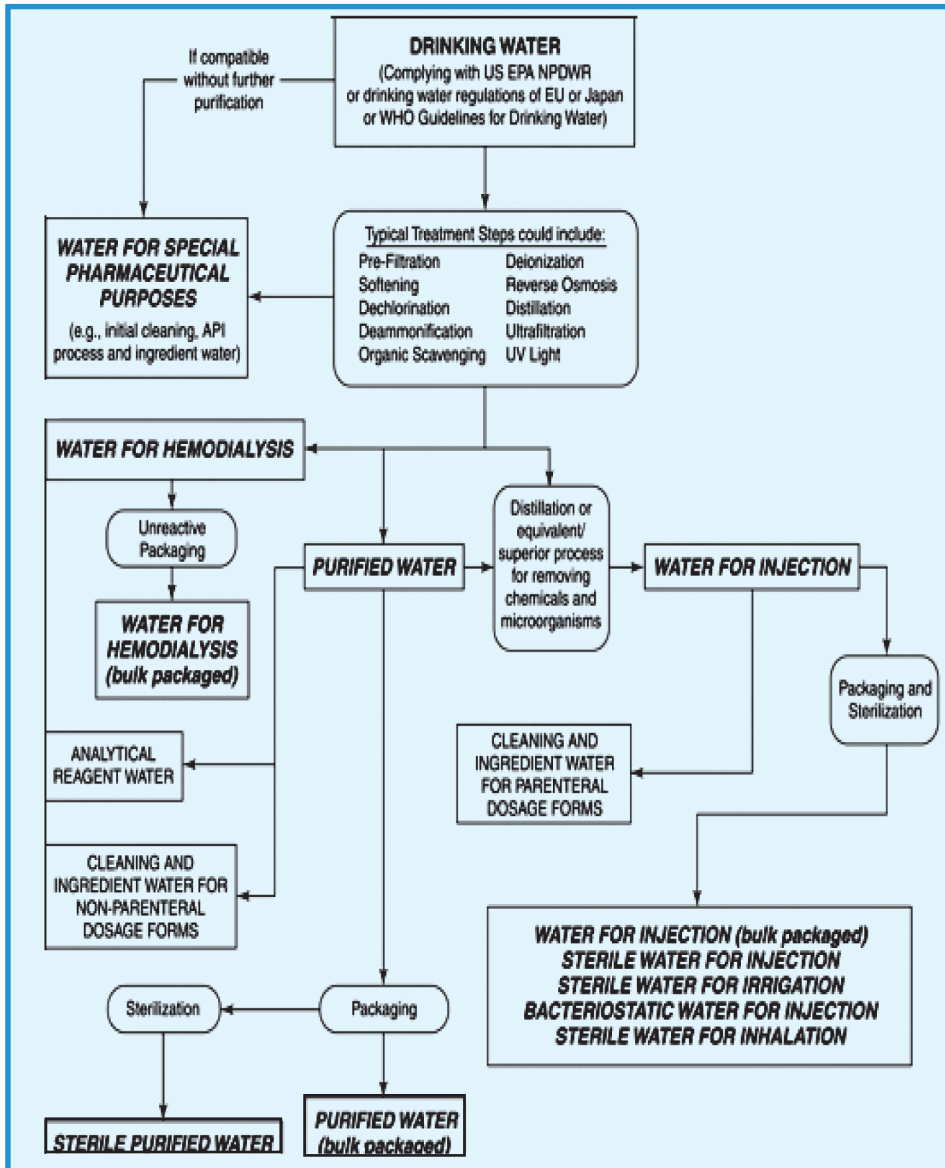

Fig 8.1 - Different grades of purified water used in pharmaceutical industries

**American Society for Testing and Materials (ASTM) Standard Specifications for Reagent Water**

ASTM Type	I	II	III	IV
Conductivity @ 25° C (micromhos/cm)	0.056	1.0	0.25	5.0
Resistivity @ 25° C (Megohms-cm)	18	1.0	4.0	0.2
Total Silica (mg/l)	3	3	500	-
Total Organic Carbon (mg/l)	100	50	200	-
Chlorides (mg/l)	1	5	10	50
Sodium (mg/l)	1	5	10	50
pH*	-	-	-	5.0–8.0

	Type A	Type B	Type C
Max Heterotropic Bacteria Count	10/1000 ml	10/100 ml	100/10 ml
Endotoxin, EU/ml	<0.03	0.25	NA

\*\*The measurement of pH in Type I, II and III reagent water has been eliminated because these grades of water do not contain constituents in sufficient quantity to alter pH.

## 8.3 USP Purified Water System

### 8.3.1 Pretreatment

Whatever be the source of water, the first step is to produce water of potable quality. All surface water supplies will be pre-chlorinated for oxidation of organics and for disinfection. Water will be coagulated, flocculated, clarified and filtered for removal of suspended solids and turbidity.

#### TDS removal

A two pass RO system provides for removal of ionic impurities to a low level. The RO skid is preceded by ultra filtration to remove colloidal particles, bacteria and viruses. A micron cartridge filter is installed prior to the high pressure pump. Dosing systems for addition of sodium meta bi sulphite (SMBS) and antiscalants and a clean in place system complete for cleaning of membranes are included. For further polishing water, mixed bed or electro-deionisation are included.

### 8.3.2 Post-treatment

The system consists of SS storage tank fitted with a 0.2 micron air filter, highly polished SS pipework and valves for distribution of purified water. The entire system will be sterilised by UV and ozone.

Typical flow diagram for production of USP purified water with ozonation system with UV for sanitisation of distribution lines.

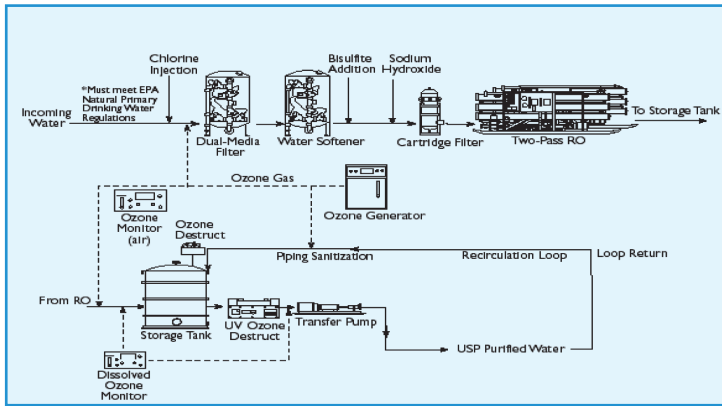

Fig 8.2 – Production of USP purified water

### 8.3.3 USP water for IV (WFI) fluids

Water used for IV fluids must in addition be free from pyrogens (endotoxins) and will be produced either by RO or double distillation.

Typical flow diagram for production of water for injectables free from pyrogens using high velocity single-effect still.

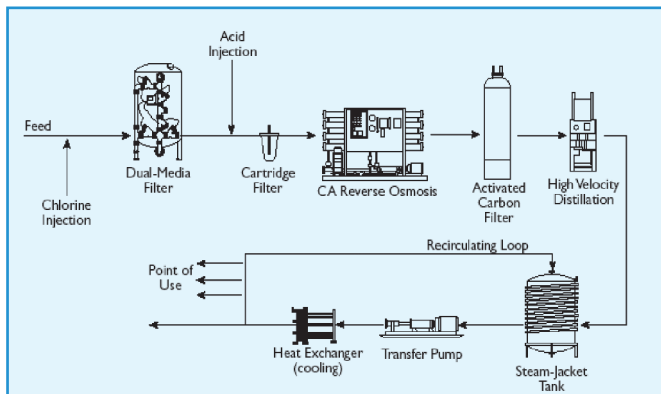

Fig 8.3 – Production of water for injectables



### 8.3.4 Electro-deionisation

The use of electro-deionisation (EDI), a membrane process used in the production of ultra pure water, has grown rapidly over the last several years. In many cases EDI has been the chosen process over conventional batch-type ion exchange processes.

There are some obvious reasons for this, such as the environmental benefit of not using hazardous regenerant chemicals and the inherent superiority of a continuous process over a batch process. There are also the benefits of high product water quality from EDI, especially when compared to other membrane processes. Finally, there are the economic benefits of EDI which make this process a real success.

EDI has succeeded over other processes as it has the ability to continuously remove weakly-ionised species. This is a very important aspect of EDI performance and, in many ways, is what separates this process from other demineralisation processes. Normally, weakly-ionised species, such as carbon dioxide, boron, and ammonia are difficult to remove via such membrane processes as reverse osmosis (RO) and electrodialysis reversal (EDR). Whereas the key gauge of an RO unit's performance is its degree of silica removal, ion exchange performance is based on how well weakly-ionised species are removed. EDI offers the benefit of continuous removal of these species to a very high degree.

### 8.3.5 EDI process

EDI is an electrically-driven membrane process. EDI combines ion exchange resins, ion exchange membranes, and a DC electrical field. Figure 8.3 illustrates the basic flow of the EDI process. In EDI, ionised species are removed much like conventional electrodialysis (ED), with the ion removal greatly increased by the presence of the ion exchange resins in the diluting cell.

These ion exchange resins facilitate mass transfer of weakly-ionised species mainly due to the phenomenon known as "water splitting". In the diluting cell, the DC electrical field splits water at the surface of the ion exchange beads, producing hydrogen and hydroxyl ions which act as continuous regenerants of

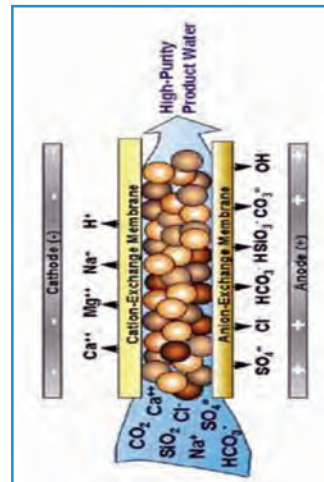

Fig 8.4 - Schematic of EDI Process

the ion exchange resins. This allows a portion of the resins in the EDI to always be in the fully regenerated state. In turn, the fully regenerated resins are able to ionise weakly-ionised species. Once ionised, these species are quickly removed under the influence of the DC electrical field.

In effect, ionised species are removed in one area of an EDI stack and weakly-ionised species are removed in a second area. Figure 8.4 roughly depicts how different ions are removed as water travels through the EDI diluting cell. Strongly-ionised ions are removed first in the flow path and weakly-ionised species removed as the water moves down the flow path. Removal of ionised species such as sodium, chloride, sulphate, and calcium by EDI is usually well over 99% and has been well documented. Removal of weakly-ionised species is an area where a properly designed EDI can also achieve extremely high removal rates.

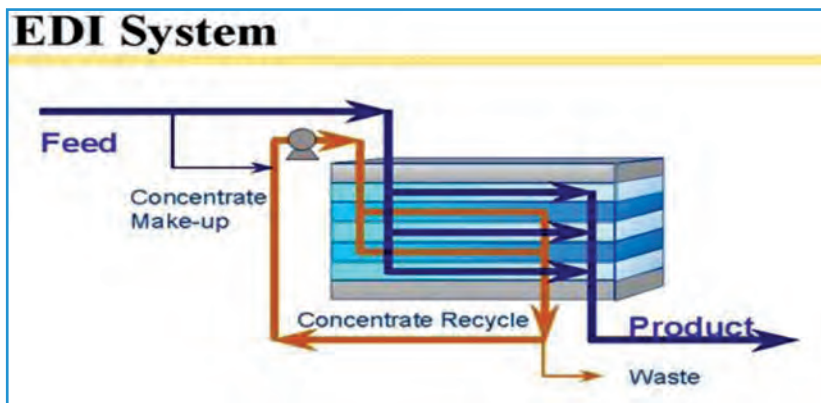

Fig 8.5 - EDI system

### 8.3.6 Silica removal

Silica is one weakly-ionised ion that receives a lot of attention in water treatment for a number of good reasons. In power or boiler applications, silica scaling is a real and constant concern for plant operations. Failure to maintain low silica levels in ultra pure waters feeding these systems can result in damage to costly equipment such as heat exchangers or turbines. In addition, high silica levels in the boiler feed water can reduce the amount of water cycling, directly reducing the efficiency of plant operations.

In semiconductor processing, high silica levels can lead to silica deposits on wafers which in turn lead to expensive chip failures. Silica levels

are usually maintained at or below what can be detected by on-line instrumentation to prevent silica from affecting a semiconductor plant's wafer yield.

EDI is an excellent process for achieving low levels of silica. Typically, EDI removes over 98% of silica in a feed water. The table below lists silica removal at three different operating plants.

The data was obtained from both on-line and laboratory silica analysers. The data shown is typical data for these EDI plants and demonstrates how EDI is able to achieve very low silica levels (less than 5 ppb), even when challenged with silica levels as high as 600 ppb or more.

Typical removal of SiO<sub>2</sub> levels and removal by EDI:

	Power Plant #1	Power Plant #2	Semiconductor Plant #1
Feed SiO <sub>2</sub> (ppb)	306	165	642
Product SiO <sub>2</sub> (ppb)	<2	<2	3.1 2.8 < 2 2.6
SiO <sub>2</sub> Removal	>99.3	>99.8	99.5

### 8.3.7 Carbon dioxide

Carbon dioxide removal by EDI is an important facet of its performance. When carbon dioxide is present in an ion exchange feed stream, the carbon dioxide competes with silica for ion exchange sites on an anion resin. Carbon dioxide often represents the largest anion load on an ion exchange system, especially when the ion exchange unit is preceded by an RO unit. The presence of excess amounts of carbon dioxide both limits the capacity of ion exchange resin to remove silica and limits the efficiency of silica removal by the ion exchange bed. As discussed above, silica removal is critical in both power generation and in semiconductor production. The presence of an excess amount of carbon dioxide in effect exposes a plant to potentially serious silica problems. Carbon dioxide cannot normally be removed via other membrane demineralisation processes such as RO and EDI unless chemical adjustments are made to change alkalinity levels. EDI, on the other hand, is a membrane demineralisation process that routinely reduces CO<sub>2</sub> levels by over 99% in most applications.

The table below summarises the carbon dioxide removal for three sites tested. Feed and product CO<sub>2</sub> were in one case (semiconductor plant #1) directly measured using an on-line TOC/TIC analyser. For the other cases, feed CO<sub>2</sub> was determined using on-line pH and ion chromatography. The product CO<sub>2</sub> levels were calculated using on-line instrumentation and ion chromatography.

Typical CO<sub>2</sub> levels and removals by EDI:

	Power Plant #1	Power Plant #2	Semiconductor Plant #1
Feed HCO <sub>3</sub> (ppb)	1830	1100	1000
Feed Free CO <sub>2</sub> (ppb)	4950	790	2080
Feed Total CO <sub>2</sub> (ppb)	6270	1580	2800
Product Total CO <sub>2</sub> (ppb)	20	12	<10
CO <sub>2</sub> Removal	99.7	99.2	>99.6

In all cases, the CO<sub>2</sub> levels achieved are in the low ppb range. In all but one case, the CO<sub>2</sub> removal is 99.4% and above. High CO<sub>2</sub> removal is a key factor that allows EDI to continuously generate product quality water at or near 18 Megohms.

### 8.3.8 Boron

Boron is a species that has previously received little attention relative to other weakly-ionised species, such as silica and carbon dioxide. Boron is usually present in water supplies at very low concentrations, and typical water analyses do not even look for the presence of boron. Boron is often present in water though it is not always completely removed by many ultra pure water production processes. This is problematic as boron can cause defects in semiconductor chip manufacturing.

The EDI unit consistently removes over 96% of the boron in the feed water. The EDI is much better at removing boron even though the pH of the EDI feed water is less than that of RO feed water. Because EDI ionises the weakly-ionised boron, it can remove this species to such a high degree.

## 8.4 High Purity Water Systems in Power Plant Operation

### 8.4.1 Condensate polishing unit

The term condensate polishing refers to the practice of polishing boiler feed water (condensate combined with make-up water) by installing a mixed bed unit at the discharge end of the condensate extraction pump. Almost all super thermal power station boilers are fitted with condensate polishers. The primary objective in having a condensate polisher is to allow the power station to come to full capacity in as short a time as possible.

The polisher vessel is spherical in shape and is located at the discharge end of the condensate extraction pump either on the direct line or in a

bypass line with a booster pump. It consists of a mixed bed polisher filled with a mixture of strong acid cation exchange resin and a strong base anion exchange resin. On exhaustion, the resins from the operator are hydro-pneumatically transferred to the regeneration area.

There are three sources of impurities that are likely to contaminate boiler feed water.

1. CRUD - corrosion products (mostly oxides of iron, nickel or copper) in the form of suspended particles introduced into the system as a result of corrosion due to circulation of boiler water in the boiler-turbine circuit. This is high during start up and comes down during normal operation.
2. Introduction of ionic impurities resulting from condenser leak - high in the case of sea water cooled condensers and low in the case of condensers cooled by river, canal or lake water.
3. The condenser is under partial vacuum and there could be air in leakage bringing in  $\text{CO}_2$  which reacts with ammonia and forms ammonium carbonate.

Under normal operating conditions the polisher removes the crud and ionic impurities present in boiler water (sodium, chloride, silica and ammonia). Whenever there is a condenser leak, the polisher will remove the additional ionic impurities for some period of time allowing the operator to shut down the plant gradually.

Power plants with all steel components operate at a pH of 9.5 to minimise corrosion and keep the protective magnetite layer intact. Around 2.5 mg/l of ammonia is added to the condensate to maintain the pH.

There are three phases in plant operation:

#### **Phase 1 - $\text{H}^+/\text{OH}^-$ cycle**

During start up, the cation resin is in  $\text{H}^+$  form and the anion resin in  $\text{OH}^-$  form. During normal operation, the resin removes sodium (less than 5 ppb), chloride (less than 5 ppb), silica (less than 5 ppb) and ammonia (around 2.5 ppm). This operation lasts typically for a week.

#### **Phase 2 - $\text{H}^+$ to $\text{NH}_4^+/\text{OH}^-$ cycle**

During the next three to four days, the cation resin gets slowly converted into ammonium form as ammonia is the major load.

### Phase 3 - $\text{NH}_4^+/\text{OH}^-$ cycle

To avoid continuous addition of ammonia to the condensate, the polisher is operated beyond ammonia breakthrough with the cation resin in  $\text{NH}_4^+$  form and the anion resin in  $\text{OH}^-$  form. The polisher is expected to operate in this mode for the next few days.

To achieve this, a number of conditions must be fulfilled. These are:

1. Transfer of resins from the operator vessel to the regenerator vessel should be complete.
2. There should be no dead pockets in the transfer piping.
3. There should be no cross contamination prior to regeneration.
4. Regeneration process should ensure that there is no residual sodium left on the cation resin after the regeneration is completed. This is important since the cation resin has higher affinity for ammonium ion as compared to sodium. In case there is residual sodium on the cation resin, the entire quantity of sodium taken up by the resin is thrown out when the resin is converted into ammonium form in the next service cycle necessitating shut down of the plant.

A number of proprietary designs for eliminating cross contamination are available. Pipe work can be designed to eliminate dead pockets. The collection system in the polisher vessel is designed to ensure complete transfer of resins from the operator to the regeneration vessel.

The regeneration system comprises of the following units:

- Resin Separation Tank (SPT)
- Cation Regeneration Tank (CRT)
- Anion Regeneration Tank (ART)

A unique separation process is used in the external regeneration to eliminate cross-contamination of the resin beads leaving the interface mixed resin as resin heel in the separation tank.

The resin separation tank is a tall narrow vessel with a wide mouth at the top. This promotes better separation of the cation and anion resins and reduces the cross-contamination, which in turn results in higher treated condensate quality. With this technology, resin cross-contamination can be controlled to less than 0.1% cation/anion and anion/cation without chemical treatment.

Ion exchange resins used in condensate polishing applications undergo considerable amount of attrition as they are transported hydro-pneumatically over long distances from the polisher vessel to the regeneration area and back to the polisher after regeneration. Resins used should therefore have sufficient physical strength to minimise attrition losses. They should also have sufficient capacity for crud removal and ion exchange capacity.

Stepwise regeneration procedure is given in Annexure-23.

#### 8.4.1.1 A typical water-steam cycle in a power plant

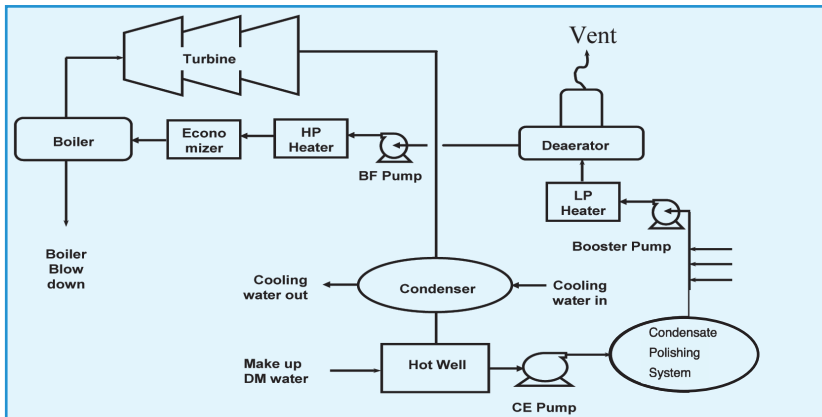

*Fig 8.6 - Typical water-steam cycle in a power plant*

Please refer to Annexure-22 for the following data relating to:

1. Typical feed condensate analysis of sub critical power plant.
2. Typical effluent condensate analysis of sub critical power plant.
3. Typical feed condensate analysis of super critical power plant.
4. Typical effluent condensate analysis of super critical power plant.
5. Feed analysis comparison for super critical power plant (660 MW) in normal operation.
6. Feed analysis comparison for super critical power plant (800 MW) in normal operation.
7. Effluent condensate analysis for super critical power plant (800 MW) for various projects.

# Chapter 09

## COOLING WATER TREATMENT

### Cooling water treatment



### Dual media filtration for a steel plant







## 9.0 COOLING WATER TREATMENT

### 9.1 Introduction

Industry uses large volumes of water for cooling of condensers and heat exchangers. Efficient management of cooling water systems can result in substantial savings of water treatment chemicals and energy.

There are three types of cooling water systems in use:

1. Once through cooling
2. Closed circuit cooling
3. Open evaporative re-circulating cooling

### 9.2 Once Through Cooling

Water is drawn from a river, lake or sea, circulated through the condenser or a heat exchanger and returned back to the source. Obviously these systems are suited for situations where a large volume of water is available and is used for applications requiring large volumes of water for cooling.



*Fig 9.1 - Once through cooling system*

Treatment of cooling water is limited to chlorination to limit bio-growth. Bar screens at the intake remove debris and marine organisms.

### 9.3 Closed Circuit Cooling Systems

Consists of two circuits: a primary circuit in which the cooling water is re-circulated through the system to be cooled and a secondary circuit where the hot water is cooled in an open re-circulating cooling water system incorporating a cooling tower.

Losses in the closed circuit are minimal and losses, if any, are made up with fresh water. Most of the systems use either soft water or demineralised water to eliminate scaling. Cooling water is treated with a corrosion inhibitor to minimise corrosion.

Examples of closed circuit cooling are engine cooling, cooling of furnace doors in steel mill condensers, in comfort cooling systems, etc.

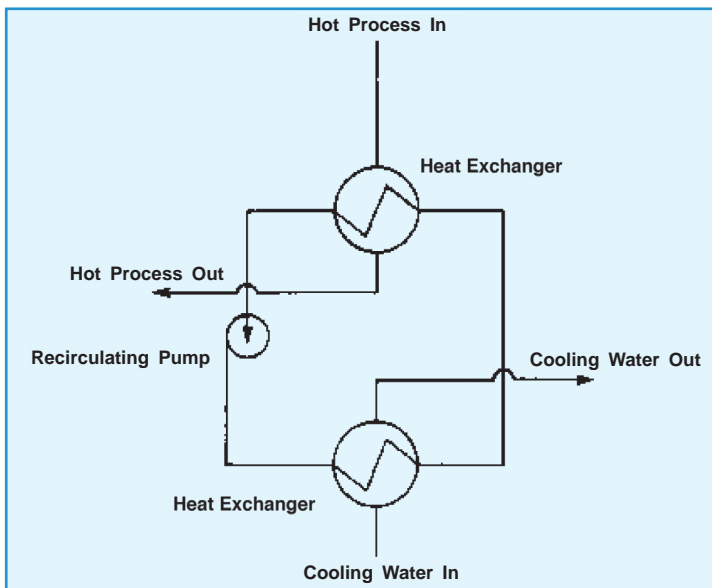
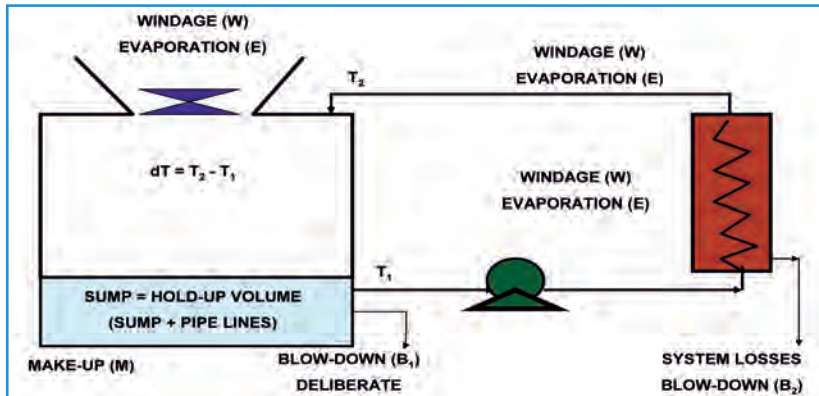

*Fig 9.2 - Closed circuit cooling system*

### 9.4 Open Evaporative Re-Circulating Cooling Water Systems

Cooling water from the cooling tower sump is pumped through the condensers or a heat exchanger and the hot water is returned to the cooling tower. Exhaust fans fitted at the top of the water allows part of the water to evaporate and in the process allows the water to cool as it falls through the tower.

Re-circulation of water results in a build up dissolved solids. Part of the water is blown down from the sump to limit the solids in re-circulating water within desirable limits. There is a small loss of water through escape of droplets of water carried away by the air (drift loss). Loss of water due to evaporation and drift is made up by addition of fresh treated water to the sump.



*Fig 9.3 - Open evaporative re-circulating cooling water system*

- Evaporation loss: The loss is approximately 1% of the flow of the re-circulating water for every 10° F drop in temperature. This loss is inevitable unless of course we opt for air cooled systems (air cooled systems are inefficient and hence used only in places where there is an acute shortage of water supply)
- Concentration of salts in cooling water increases operational problems like scaling, corrosion and fouling as a result of re-circulation. This can result in operational problems like scaling corrosion and fouling. Cooling water gets contaminated with dust, dirt, microbial spores, and process leaks vented to atmosphere, etc. by the current or dry air entering the cooling tower
- A small amount water is therefore blown down from the sump
- The loss of water due to evaporation, drift loss and blowdown is made up by addition of fresh make-up water on a continuous basis

## 9.5 Operational Problems

### 9.5.1 Scaling

Scaling is due to the presence of hardness salts in water which tend to precipitate as temperature is increased. In cooling water system the culprit is usually calcium bicarbonate which gets precipitated as  $\text{CaCO}_3$ .

There are at least four methods of preventing scale:

1. Convert temporary hardness into permanent hardness by addition of sulphuric acid into the cooling tower (CT) sump.
2. Use softened water as make-up to CT (most of the power plants in India use soft water as make-up.)
3. Add scale inhibitors which convert scales into amorphous matter. Add dispersants to keep hardness precipitates in suspension. Examples include polyphosphates, tannin, phosphonates, polycarboxylic acid and polymaleic acid.
4. Operate the system with a negative Langelier Index and add corrosion inhibitors to minimise corrosion. However this option is not the preferred one as it is more difficult to control corrosion than scaling. Operating a system with a thin scale will always yield good results.

### 9.5.2 Corrosion

Corrosion is mostly electro-chemical in nature and occurs due to small imperfections on metal surfaces present during manufacture. It cannot be totally eliminated as it is natural for metals to revert back to their original state of ore.

Methods to prevent corrosion include:

1. Add corrosion inhibitors to minimise corrosion
  - Cathodic inhibitors: zinc, calcium carbonate, polyphosphate and phosphate.
  - Anodic inhibitors: chromates, molybdates, phosphate and polyphosphate, nitrite and phosphonates.
2. Operate the system with a positive Langelier Index to minimise corrosion, and use scale inhibitors to eliminate scaling.

#### Corrosion Inhibitors

Cathodic	Anodic
Zinc	Chromates
Calcium Carbonate	Molybdates
Polyphosphate	Phosphate and Polyphosphate
Phosphate	Nitrite
	Phosphonates

**Table showing Inhibitors and their limitations**

Antiscalant	Scale Inhibitor	
	Threshold Inhibition	Crystal Modifications
Polyphosphates	Yes	-
Tannin	-	Yes
Phosphonates	Yes	-
Polycarboxylic acid	Yes	Yes
Polymaleic acid	Yes	Yes

### 9.5.3 Fouling

There are two types of fouling - one due to presence of suspended solids (SS) and particles of dust coal dust which tend to get deposited on heat transfer surfaces in low velocity areas resulting in 'under deposit corrosion'. The other type of fouling results from biological impurities - algae, fungi and bacteria. Bio-fouling results in reduced heat transfer and also corrosion.

Fouling due to deposits can be controlled by installing 'side stream filters'. Around 3-5% of the re-circulation flow is filtered through these filters.

Bio-fouling can be controlled by addition of a combination of oxidising and non-oxidising biocides. The cheapest available oxidising biocide is chlorine. Chlorine dissolves in water and forms hypochlorous (HOCl) and hydrochloric (HCl) acids. HOCl is an effective biocide.

At elevated pH, HOCl forms hypochlorite (OCI) ion which is not very effective. Chlorine dioxide (ClO<sub>2</sub>) and bromine are alternative biocides.

Non-oxidising biocides are usually proprietary formulations. The basic ingredients include quaternary ammonium compound. Non-oxidising biocides need to be bio-degradable and lose effectiveness after the initial kill of bacteria by over 90%. The bacterial growth starts again and is again killed by addition of biocides after it reaches unacceptable levels of 2X10<sup>-5</sup> org/ml.

The best approach towards microbial control is to keep a static control by using chlorine continuously and overcoming its limitations by converting it into bromine for higher pH systems and systems contaminated with ammonia.

Use of bio-dispersants helps chlorine to penetrate slimes.

## 9.6 Cycles of Concentration (COC)

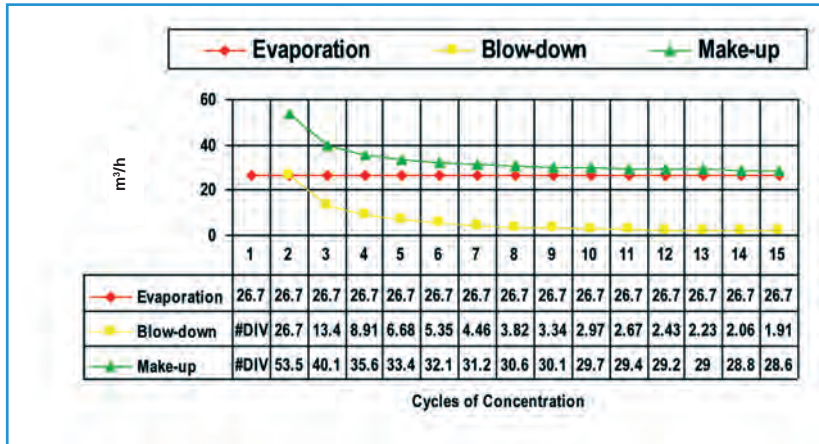

Fig 9.4 - Make-up water requirements as a function of cycles of concentration

Estimating water balance in cooling tower is given in Annexure-9.

## 9.7 Recovery of Water from Blowdown

It is possible to recover water for reuse from cooling tower blowdown (CTBD). Blowdown water has moderately high TDS and silica and hardness. Feed water TDS can easily be estimated as feed water TDS x Cycles of concentration (COC)

Silica can be reduced by adsorbing it on MgO precipitate in a high rate solids contact clarifier by addition of lime and dolomite and a flocculant.

Clarified water will be filtered and treated through an RO unit for removal of TDS. An ultra filter removes colloidal particles and microorganisms.

Hardness in cooling water is removed either by a softener or by addition of antiscalants. Addition of sodium meta bisulphate (SMBS) will remove free residual chlorine which may be present.

# Chapter 10

## BOILER FEED WATER TREATMENT

**Demineralisation section at a chemical plant**



**Softener at a power plant**







## 10.0 BOILER FEED WATER TREATMENT

### 10.1 Introduction

Boilers convert water into steam using the heat input from fuels like coal, fuel oil or natural gas. Steam is used to generate power, run machinery, heat liquids and for distillation processes.

### 10.2 Classification of Boilers

Boilers are broadly classified into land and marine boilers based on their location. Land boilers are further classified into shell or fire tube and water tube boilers.

Shell or fire tube boilers produce steam by heat transfer from the heat source into water confined within a cylindrical vessel or a shell. Hot gases pass through a sequence of tubes and are designed as packaged units ready to be installed and started up, and requiring only connection to services like fuel, water and electricity to function.

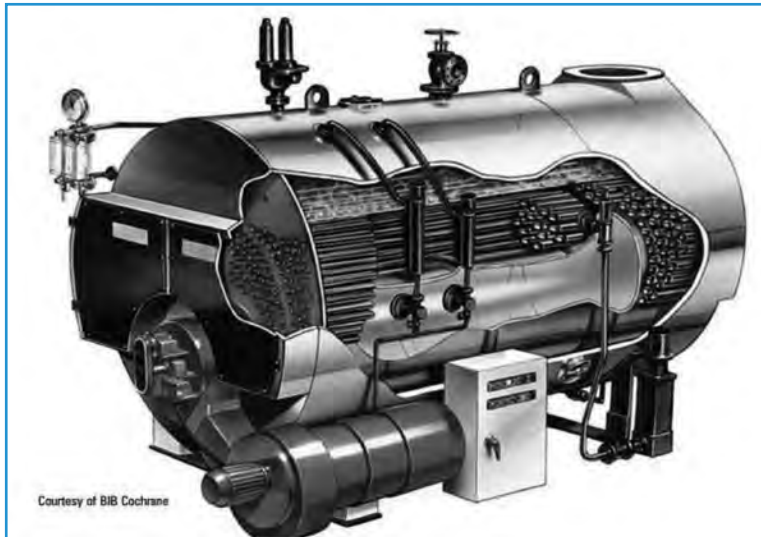

*Fig 10.1 - View of shell type boiler*

Water tube boilers produce steam by heat transfer from the heat source into water confined within a tube. Water tube boilers consist of a 'steam drum' and a 'mud drum' interconnected by tubes arranged in a particular

shape. As evaporation takes place, the dissolved solids present in incoming water get concentrated in the boiler water in the steam/mud drum. Continuous or intermittent blow down from the steam drum helps in maintaining the solids in boiler water within the limits prescribed by the boiler manufacturer. Any precipitates or sludge formed is periodically removed from the system by blowdown from the mud drum.

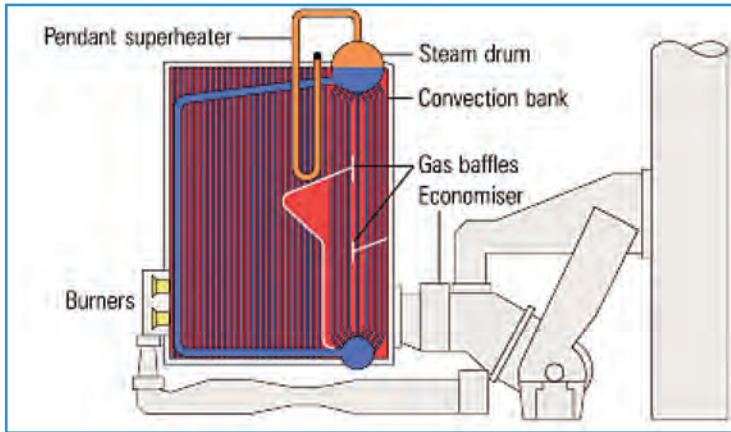
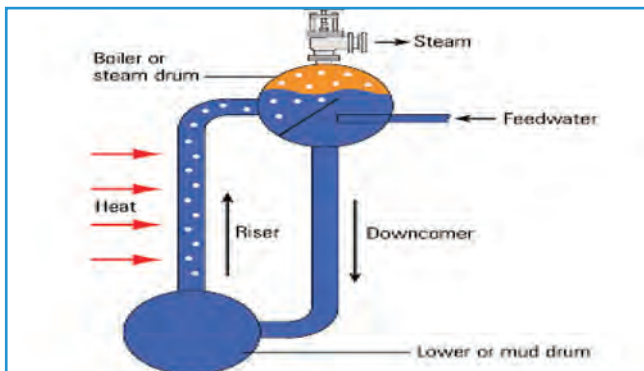

*Fig 10.2 - Typical water tube boiler*

Water tube boilers are further classified into natural circulation, forced circulation and once through boilers.

### 10.2.1 Natural circulation boilers

Where the density difference between steam and water causes the circulation of water through the riser and downcomer tubes. The steam drum and the mud drum are connected through these tubes.



*Fig 10.3 - Natural circulation boilers*

### 10.2.2 Forced circulation boilers

In these boilers the density difference between steam and water is very low for natural circulation to take place and hence a pump is used to force the water from the mud drum to the steam drum through the riser tubes.

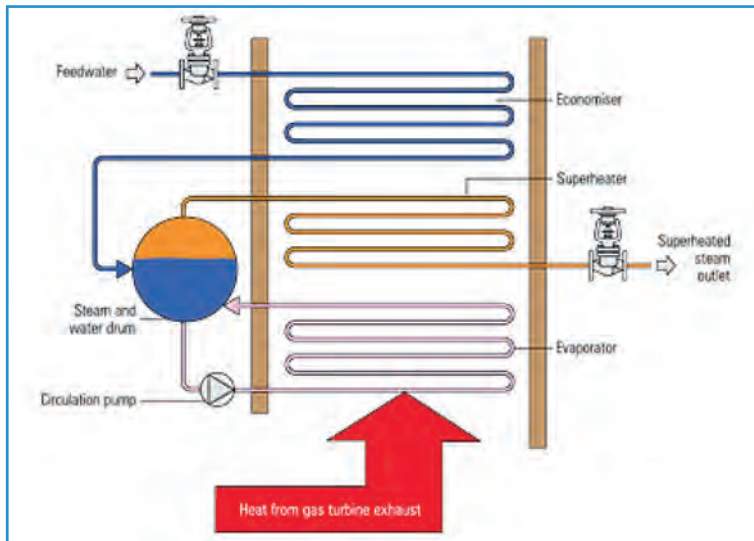

*Fig 10.4 - Forced circulation boilers*

### 10.2.3 Once through boilers

In these boilers, the entire quantity of incoming feed water is evaporated in the tube and there is no drum to contain and concentrate the solids entering the circuit. These boilers therefore require water of a high purity and boiler water is treated with all volatile chemicals.

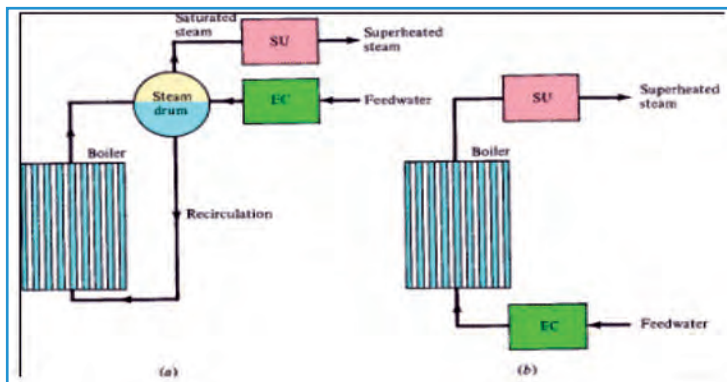

*Fig 10.5 - Once through boilers*

### 10.3 Operational Problems

There are generally three problems encountered during the operation of boilers:

1. Scaling and or deposits
2. Corrosion and
3. Carryover of solids into steam (caused by priming and or foaming)

#### 10.3.1 Scaling and/or deposits

Scaling is caused by the presence of hardness salts in feed water to the boiler. Solubility of hardness salts decreases with an increase in temperature and tends to precipitate on the boiler tube. Scales are crystalline and are heat insulators. Build-up of scale reduces water flow and retards heat transfer from the hot gases to water resulting in an increase in fuel consumption. Overheating of tubes can result in an explosion.



*Fig 10.6 – Photograph of severely scaled boiler tube*

#### 10.3.2 Boiler deposits

Hardness in water can be removed by processes like softening or demineralisation. Deposits are normally corrosion products brought from other parts of a boiler system and allowed to deposit at low flow areas. Deposits too must be removed from the system as they can promote corrosion as well.



*Fig 10.7 - Photograph of boiler tubes with deposits*

**Common deposits in boilers**

Type	Typically caused by
Silica	Steam Blanketing/Low OH/High BFW silica
Alumina	Steam Blanketing/BFW Alumina
Iron Oxide	BFW Iron/Condensate Corrosion/Pre-boiler corrosion
Copper	BFW Copper/Condensate Corrosion/Pre-boiler Corrosion
Sodium Salts	Evaporation to dryness
High Solids	Improper control of TDS

**10.3.3 Corrosion**

Corrosion is due to the presence of dissolved oxygen and carbon dioxide in feed water. Dissolved oxygen results in a pitting type of corrosion and can be removed by deaeration in a thermal deaerator and or by addition of an oxygen scavenger like sodium sulphite or hydrazine. Hydrazine is considered carcinogenic and is being replaced by DEHA (diethyl hydroxyl amine).

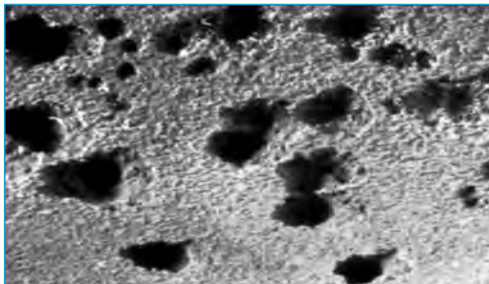

*Fig 10.8 - Boiler tube with pitting type corrosion*

### Types of corrosion in boilers

Type	Typically caused by
Oxygen Attack	BFW oxygen
Alkalinity Concentration	Concentration of caustic under deposits
Acid Attack	Acid leaks into BFW or condensate
Chelant/Polymer Attack	Excessive chemical concentration
Ammonia Attack	High ammonia returned in condensate or from BFW

Carbon dioxide volatilises with steam and dissolves in the condensate resulting in a grooving type of corrosion. It can be eliminated by addition of ammonia or an amine (morpholine, cyclohexyl amine or a filming amine).

#### 10.3.4 Carryover

Carryover is the general term that describes all types of entrainment of water from the boiler into the steam, caused by foaming, priming or mechanical separator inefficiency. Impurities in steam may arise from volatilisation of dissolved solids in boiler waters. This possibility increases with increasing boiler pressure.

#### 10.3.5 Foaming

Steam released from bursting bubbles moves towards the steam outlet carrying with it the smaller water droplets and sweeping any foam present in the same direction. The steam also drags the surface of the boiler water towards the steam outlet, so that the water level there may be higher than elsewhere. Depending upon the location of the water level indicators and controls, this may be followed by the automatic or manual admission of more water to the boiler, further increasing the water level.

#### 10.3.6 Priming

Several of the mechanical factors that tend to produce carryover may reinforce each other; for example, as the general water level is raised, the volume of the steam space is decreased, the velocity of the steam across the surface is thereby increased and the cloud of water droplets and foam are brought nearer to the steam outlet. Also, sudden large increases in steam demand cause a temporary reduction in pressure with a consequent increase in the specific volume of the steam.

This may result in slugs of boiler water entering the steam outlet. This condition is known as priming.

Additionally, operating the boiler below the design pressure will have a similar effect.

Factors that influence carryover are:

- a) Boiler water level
- b) Steaming rate
- c) Sudden changes in steam demand
- d) Operation at less than the design pressure of the boiler

Impurities in boiler water tend to increase the surface tension of the water and so impair the separation of steam from the water, thus increasing the tendency to foam. Dissolved solids, and particularly those causing caustic alkalinity, suspended solids, oil, detergents and organic impurities can stabilise the bubble film.

**Antifoams** Addition of a few mg/l of certain surface active agents to the boiler water can overcome foaming. The choice of the antifoam depends on operating conditions. Foaming is primarily due to frequent upsets in heat load. It can be corrected by operating the boiler at more or less uniform load.

**Foaming** can also be due to presence of organic impurities in feed water. Adequate treatment of water coupled with addition of antifoam should help in most cases.

## 10.4 Blowdown

All boiler make-up water contains impurities. As steam is released, impurities build up. The increasing concentration of these impurities, such as dissolved solids, can lead to carryover into the steam causing damage to piping, steam traps and even process equipment. In order to maintain boiler water solids within the limits prescribed by the boiler manufacturer, a small portion of boiler water is removed from the system. This is called 'blowdown'. Blowdown is released from beneath the water surface in the steam drum, mud drum, bottom header or from the bottom of the boiler. Blowdown rates can vary from one percent (of feed water) to as much as 10%. Too little blowdown can result in build up of impurities and too much of it can lead to waste of water, treatment chemicals and energy.

Percentage blowdown =  $\frac{\text{TDS (mg/l) of feedwater}}{\text{TDS (mg/l) of blowdown}}$  expressed as a percentage of feed water flow.

Maximising condensate return is another way to minimise blowdown water. Increasing condensate return increases cycles of concentration, decreases chemical usage, decreases blowdown and conserves the heat value of condensate.



## 10.5 Boiler Feed Water Treatment

### 10.5.1 Low and medium pressure boilers

Feed water to low and medium pressure boilers is generally softened to prevent scaling.

Addition of catalysed sodium sulphite or hydrazine removes dissolved oxygen. Corrosion of condensate return lines is minimised by addition of an amine.

**a) Softening** - The process of softening removes only hardness. All other parameters like alkalinity, dissolved solids or silica remain unaltered. One should determine the parameter limiting blowdown and alter the treatment scheme accordingly. Processes alternative to softening are:

**b) Dealkalisation** - The process involves the use of a weak acid resin in  $H^+$  form which removes alkalinity associated with hardness (temporary hardness). The process is most suited to waters in which alkalinity is either equal to or exceeds hardness. Dissolved solids get reduced to the extent of hardness removal.

Alkalinity can also be removed by blending softened water with water passed through a strong acid cation exchanger in  $H^+$  form. Alkalinity present in softened water neutralises the acidity present in SAC treated water.

**c) Desilicisation** - This process is most suited to those waters where TDS is low but silica is high and hence is the limiting parameter for blowdown. The process involves the use of a strong base resin in  $OH^-$  form which removes silica to a very low level. The feed must be softened to prevent hardness deposition on the strong base resin.

**d) Demineralisation** - Demineralisation involves complete removal of dissolved solids. Demineralisation by ion exchange process uses ion exchange resins that are styrene-DVB based copolymers with a functional group.

Two types of Ion exchange resins are used. A strong acid cation (SAC) exchanger converts all the salts present in water into acids which are neutralised by the strong base anion (SBA) resins, producing water free from dissolved solids.

Reverse osmosis (RO) followed by mixed bed (MB) demineralisation is also used for removal of dissolved solids.

### 10.5.2 High pressure boilers

Feed water to high pressure boilers must be high purity. Demineralised water (conductivity less than  $2\mu\text{S}/\text{cm}$  @  $25^\circ\text{C}$  and total silica less than 20 ppb as  $\text{SiO}_2$ ). The treatment scheme is:

1. SAC-Degasser-SBA-MB or
2. RO-Degasser-MB

DM water is deaerated in a thermal deaerator and dosed with hydrazine for removal of residual oxygen. Ammonia or an amine like morpholine or cyclohexyl amine is added to prevent condensate return.

## 10.6 Boiler Water Treatment for High Pressure Boilers

Boiler water chemistry for drum boilers has evolved in the last few years for two primary reasons. First, much more is known today about water wall corrosion mechanisms, particularly with regard to traditional treatment programs. Secondly, issues related to carryover of products from boiler drums to steam turbines are also much better understood.

Basic objective of all boiler water treatment programmes is to eliminate or minimise corrosion of all parts of the boiler-turbine circuit.

Mild and low alloy steels are used mainly in the construction of boilers, heat recovery steam generator (HRSG) evaporators and feed water heaters. Copper alloys can be used in condensers. High alloy steels and austenitic stainless materials are used in super heaters, re-heaters and steam turbines. Protection against corrosion is provided by the protective oxides which grow on all the surfaces.

In conventional fossil fuelled and HRSG plants a number of corrosion mechanisms can occur in the water/steam cycle. These are:

Under deposit corrosion (UDC) can lead to hydrogen damage, caustic gouging and acid phosphate corrosion.

Hydrogen damage occurs when acidic conditions concentrate beneath deposits. Caustic gouging occurs when caustic soda concentrates beneath the deposits. Acid phosphate corrosion takes place when acid phosphates (di-and/or mono-sodium phosphate) concentrate beneath the deposits.

Flow accelerated corrosion (FAC) is the accelerated dissolution of the protective layer of magnetite on the surface of carbon steel components. It occurs typically at locations of turbulence in the flow.

Corrosion fatigue (CF) is the failure of boiler components due to repetitive applied stress causing damage to the protective oxide layer.

Pitting corrosion occurs due to inadequate shut down procedures throughout the cycle.

Stress corrosion cracking (SCC) is the corrosion of stainless steel components in the super heater, re heater and steam turbine due to presence of impurities like NaOH and chloride.

There are essentially three treatment programmes for high pressure boilers and HRSG evaporators

1. All volatile treatment (AVT) - Only alkalisng agents, typically ammonia or an amine are added to boiler water. There are two variations of AVT viz

AVT (O) - carried out under oxidising conditions. This is the feed water treatment programme now employed for most drum units. In this programme, the small amount of air that leaks in through the condenser is allowed to remain and ammonia is injected to raise the pH to a range of 9.2 to 9.6.

If the cation conductivity of the feed water is maintained below  $0.2 \mu\text{S}/\text{cm}$ , the magnetite ( $\text{Fe}_3\text{O}_4$ ) layer that naturally develops on carbon steel becomes interspersed and covered with a coating of ferric oxide hydrate ( $\text{FeOOH}$ ), which is not susceptible to Flow Accelerated Corrosion (FAC).

AVT(R) - carried out under reducing conditions by addition of hydrazine. This results in the formation of a protective layer of magnetite ( $\text{Fe}_3\text{O}_4$ ) which is a combination of  $\text{FeO}$  and  $\text{Fe}_2\text{O}_3$ .

2. Oxygenated treatment (OT) - Both ammonia and oxygen are added to the boiler water. With OT, pure oxygen is deliberately injected into the condensate and feed water to induce formation of the  $\text{FeO} \cdot \text{OH}$  protective coating. The condensate must be very pure (cation conductivity  $\leq 0.15 \mu\text{S}/\text{cm}$ ) for this treatment to work properly. Hence, this programme is restricted to plants fitted with condensate polisher.
3. Phosphate treatment (PT) - Phosphate treatment of drum boilers is still the most common method to protect the boiler components against corrosion, coordinated and congruent phosphate treatments, where the chemical feed consisted primarily of tri-sodium phosphate ( $\text{Na}_3\text{PO}_4$ ) but with some di-sodium phosphate ( $\text{Na}_2\text{HPO}_4$ ) and even sometimes mono-sodium phosphate ( $\text{NaH}_2\text{PO}_4$ ) blended in, are no longer practised.

Under PT, only tri-sodium phosphate ( $\text{Na}_3\text{PO}_4$ ) is utilised, with perhaps a bit of caustic (less than 1 part-per-million (ppm)).

While the recommended phosphate range is 0.2 ppm (absolute minimum) to 10 ppm, most chemists tend to control chemistry at the lower end of the range. This can lead to 'phosphate hide out' and to the potential for solids carryover into steam,

The typical pH range for this programme is 9.0 to 10.0, with no more than 1 ppm of free caustic.

A very critical aspect of these programmes is that even minor in-leakage of contaminants from a condenser tube leak may introduce chlorides and sulphates to the boiler water. These contaminants and chlorides in particular, can concentrate underneath deposits and initiate hydrogen damage of boiler tubes.

4. Caustic Treatment (CT) - An alternative to phosphate treatment is caustic treatment of evaporator circuits. The advantages of caustic treatment is two-fold.

One, the elimination of phosphate also eliminates phosphate carryover to the turbine, which has been a problem at numerous plants. Secondly, caustic is best at neutralising chloride or sulphate salts that may enter the system. However, NaOH chemistry must be carefully monitored as caustic can directly attack boiler tubes, particularly under deposits.

## 10.7 Condensate treatment

Contaminants likely to be present in condensates are:

- 'Crud' or corrosion products, mostly oxides of iron, nickel or copper
- Dissolved solids present as ionic impurities
- Hydrocarbons

Treatment schemes used for the treatment of condensate may include one of the following:

### **Scheme-1 SAC – MB**

The strong acid cation polisher acts as a filter to remove suspended particles, if any, present in the condensate. It also converts dissolved solids into acids which are readily removed in the mixed polisher.

### **Scheme-2 Micron Cartridge Filter - MB**

If it is suspected that the condensate has only suspended iron particles, the micron cartridge filter will remove the same. The MB unit will polish the water.

### **Scheme-3 Oil Coalescer - MB**

Condensate may have traces of oil (hydrocarbons) due to a leak in the heat exchanger especially if the steam has been used as the heating medium for hydrocarbon streams.

Traces of hydrocarbons can be removed from condensate in oil coalescers using an oleophobic **INDION** OSR resin which removes oil from condensate contaminated with traces of oil.

The treated condensate can then be polished in a MB polisher.

### **Scheme-4 Primary ACF/Secondary ACF - MB**

The scheme uses activated carbon having large pores for adsorption of oil in condensate. Two units - primary and secondary, are used in series with provision for interchanging the piping connections.

The primary unit removes oil by straining and the secondary by adsorption. On exhaustion, carbon from the primary is replaced with fresh carbon and the piping connections are interchanged such that the vessel which was originally the primary unit is now the secondary unit and vice versa.

Treated water from the pair of units is treated in a mixed bed polisher.

# Chapter 11

## DESALTING PROCESS

**Sea water reverse osmosis at a thermal plant**





## 11.0 DESALTING PROCESSES

### 11.1 Introduction

The term desalting refers to the removal of salts from water - mostly from sea or brackish water, and falls into two broad categories – thermal and membrane processes.

Thermal processes include Multi Stage Flash Distillation (MSF), Multiple Effect Distillation (MED) and Vacuum Compression Distillation (VCD).

Membrane processes include Reverse Osmosis (RO), Electro Dialysis (ED) and Electro Dialysis Reversal (EDR).

### 11.2 Multi Stage Flash Distillation (MSF)

In the MSF process, sea water is heated in a vessel called the brine heater. This is generally done by condensing steam on a bank of tubes that passes through the vessel which, in turn, heats the sea water. This heated sea water then flows into another vessel, called a stage, where the ambient pressure is such that the water will immediately boil. The sudden introduction of the heated water into the chamber causes it to boil rapidly, almost exploding or flashing into steam. Generally, only a small percentage of this water is converted to steam (water vapour), depending on the pressure maintained in this stage, since boiling will continue only until the water cools (furnishing the heat of vaporisation) to boiling point. Typically, an MSF plant can contain from 4 to about 40 stages.

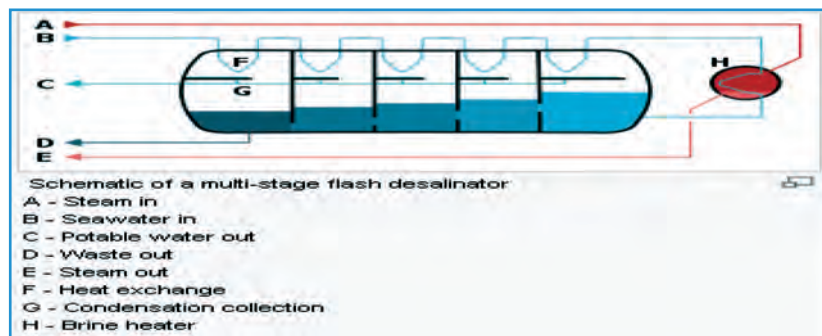

*Fig 11.1 - Multi stage flash evaporator*



The steam generated by flashing is converted to fresh water by being condensed on tubes of heat exchangers that run through each stage. The tubes are cooled by the incoming feed water going to the brine heater. This, in turn, warms up the feed water so that the amount of thermal energy needed in the brine heater to raise the temperature of the sea water is reduced.

Multi stage flash plants have been built commercially since the 1950s. They are generally built in units of about 4,000 to 30,000 m<sup>3</sup>/d (1 to 8 mgd). The MSF plants usually operate at the top feed temperatures (after the brine heater) of 90 - 120° C. One of the factors that affects the thermal efficiency of the plant is the difference in temperature from the brine heater to the condenser on the cold end of the plant. Operating a plant at the higher temperature limits of 120° C tends to increase the efficiency, but it also increases the potential for detrimental scale formation and accelerated corrosion of metal surfaces.

### 11.3 Multiple Effect Distillation (MED)

Multiple effect distillation (MED), like the MSF process, takes place in a series of vessels (effects) and uses the principle of reducing the ambient pressure in the various effects. This permits the sea water feed to undergo multiple boiling without supplying additional heat after the first effect.

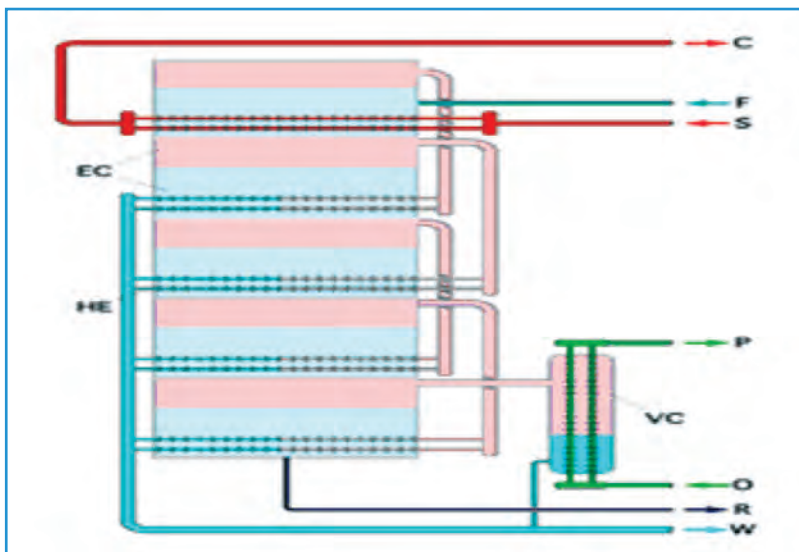

Fig 11.2 - Multiple effect distillation system

In an MED plant, the sea water enters the first effect and is raised to the boiling point after being pre-heated in tubes. The sea water is either sprayed or otherwise distributed onto the surface of evaporator tubes in a thin film to promote rapid boiling and evaporation. The tubes are heated by steam from a boiler, or other source, which is condensed on the opposite side of the tubes. The condensate from the boiler steam is recycled to the boiler for reuse.

Only a portion of the sea water applied to the tubes in the first effect is evaporated. The remaining feed water is fed to the second effect, where it is again applied to a tube bundle. These tubes are in turn being heated by the vapours created in the first effect. This vapour is condensed to fresh water product, while giving up heat to evaporate a portion of the remaining sea water feed in the next effect. This continues for several effects, with 8 or 16 effects being found in a typical large plant.

MED plants are typically built in units of 2,000 to 10,000 m<sup>3</sup>/d (0.5 to 2.5 mgd). Some of the more recent plants have been built to operate with a top temperature (in the first effect) of about 70° C, which reduces the potential for scaling of sea water within the plant but, in turn, increases the need for additional heat transfer area in the form of tubes.

#### 11.4 Vapour Compression (VC) Distillation

The vapour compression (VC) distillation process is generally used for small and medium scale sea water desalting units and for evaporating RO reject stream. The heat for evaporating the water comes from the compression of vapour rather than the direct exchange of heat from steam produced in a boiler.

The plants which use this process are generally designed to take advantage of the principle of reducing boiling point temperature by reducing the pressure. Two primary methods are used to condense vapour so as to produce enough heat to evaporate incoming sea water: a mechanical compressor or a steam jet. The mechanical compressor is usually electrically driven, allowing the sole use of electrical power to produce water by distillation.

With the steam jet-type of VC unit, also called a thermo compressor, a venturi orifice at the steam jet creates and extracts water vapour from the main vessel, creating a lower ambient pressure in the main vessel. The extracted water vapour is compressed by the steam jet. This mixture is condensed on the tube walls to provide the thermal energy (heat of condensation) to evaporate the sea water being applied on the other side of the tube walls in the vessel.

VC units are usually built in the 20 to 2,000 m<sup>3</sup>/d (0.005 to 0.5 mgd) range. They are often used for resorts, industries and drilling sites where fresh water is not readily available.

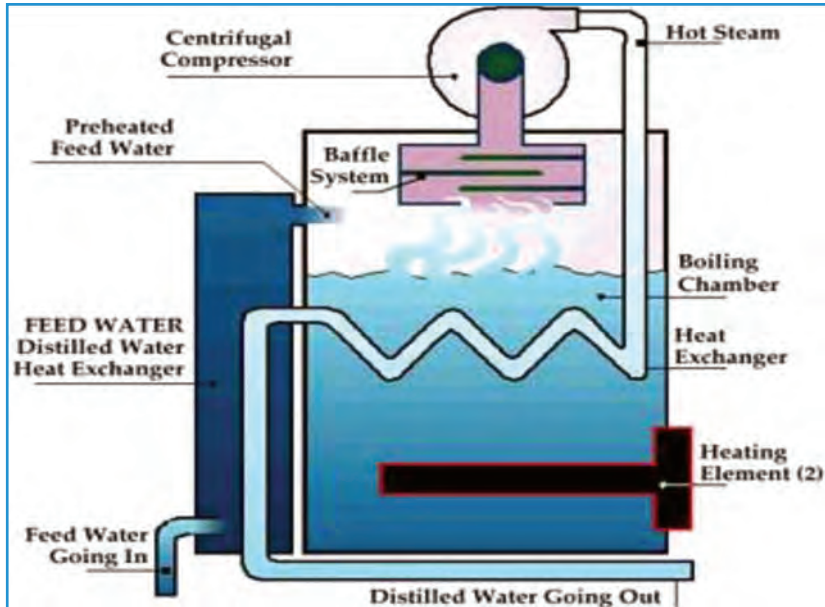

*Fig 11.3 - Schematic view of vapour compressor distillation system*

## 11.5 Electro Dialysis

Electro dialysis is a cost-effective way to desalt brackish water and depends on the following general principles:

- Most salts dissolved in water are ionic, being positively (cationic) or negatively (anionic) charged
- These ions are attracted to electrodes with an opposite electric charge
- Membranes can be constructed to permit selective passage of either anions or cations

The dissolved ionic constituents in a saline solution, such as sodium (+), chloride (-), calcium (+ +), and carbonate (- -), are dispersed in water, effectively neutralising their individual charges. When electrodes connected to an outside source of direct current like a battery are placed in a container of saline water, electrical current is carried through the solution, with the ions tending to migrate to the electrode with the opposite charge.

For these phenomena to desalinate water, membranes that will allow either cations or anions (but not both) to pass are placed between a pair of electrodes. These membranes are arranged alternatively with an anion-selective membrane followed by a cation-selective membrane. A spacer sheet that permits water to flow along the face of the membrane is placed between each pair of membranes.

The basic electro dialysis consists of several hundred cell pairs bound together with electrodes on the outside, and referred to as a membrane stack. Feed water passes simultaneously in parallel paths through all of the cells to provide a continuous flow of desalted product water and brine to emerge from the stack. Depending on the design of the system, chemicals may be added to the streams in the stack to reduce the potential for scaling. An electro dialysis unit is made up of the following basic components:

- Pretreatment
- Membrane stack
- Low pressure circulation pump
- DC power supply (rectifier)
- Post-treatment

## 11.6 Electro Dialysis Reversal Process (EDR)

The electro dialysis reversal process (EDR) unit operates on the same general principle as a standard electro dialysis plant except that both the product and the brine channels are identical in construction. At intervals of several times an hour, the polarity of the electrodes is reversed, and the flows are simultaneously switched so that the brine channel becomes the product water channel, and the product water channel becomes the brine channel.

The result is that the ions are attracted in the opposite direction across the membrane stack. Immediately following the reversal of polarity and flow, enough of the product water is dumped until the stack and lines are flushed out, and the desired water quality is restored. This flush takes about 1 or 2 minutes, and then the unit can resume producing water. The reversal process is useful in breaking up and flushing out scales, slime and other deposits in the cells before they can build up and create a problem. Flushing allows the unit to operate with fewer pretreatment chemicals and minimises membrane fouling.

Electro dialysis has the following characteristics that lend it to various applications :

- Capability for high recovery (more product and less brine)
- Energy usage that is proportional to the salts removed
- Ability to treat water with a higher level of suspended solids than RO
- Lack of effect by non-ionic substances such as silica
- Low chemical usage for pretreatment

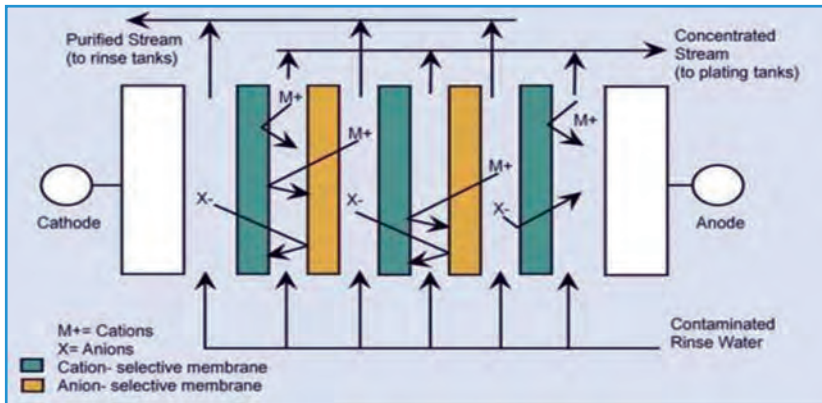

Fig 11.4 - Schematic diagram of electro dialysis reversal process

## 11.7 Reverse Osmosis (RO)

Reverse osmosis (RO) is a membrane separation process in which the water from a pressurised saline solution is separated from the solutes (the dissolved material) by flowing through a membrane. No heating or phase change is necessary for this separation. The major energy required for desalting is for pressurising the feed water.

In practice, the saline feed water is pumped into a closed vessel where it is pressurised against the membrane. As a portion of the water passes through the membrane, the remaining feed water increases in salt content. At the same time, a portion of this feed water is discharged without passing through the membrane.

Without this controlled discharge, the pressurised feed water would continue to increase in salt concentration, creating problems such as precipitation of supersaturated salts and increased osmotic pressure across the membranes. The amount of the feed water discharged to waste in this brine stream varies from 20% to 70% of the feed flow, depending on the salt content of the feed water.

An RO system is made up of the following basic components:

- Pretreatment
- High pressure pump
- Membrane assembly
- Post-treatment

RO membranes are made in a variety of configurations. Commercially successful are spiral wound, hollow fibre, plate and frame, and tubular. These configurations are used to desalt both brackish and sea water, although the construction of the membrane and pressure vessel will vary depending on the manufacturer and expected salt content of the feed water.

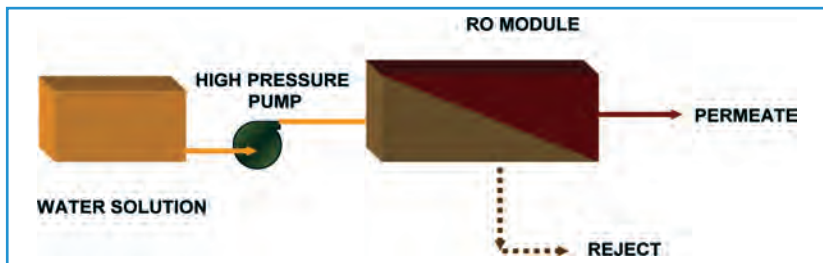

Fig 11.5 - Block diagram for typical RO system

### 11.7.1 Spiral wound membrane element

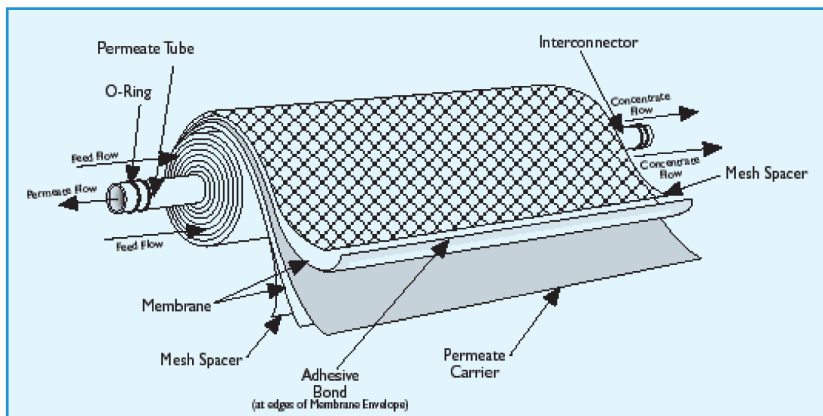

Fig 11.6 - Cut away view of spiral wound membrane element

### 11.7.2 RO skid



*Fig 11.7 - Photograph of fully assembled RO skid*

### 11.7.3 Developments in RO processes

Two developments have helped to reduce the operating costs of RO plants during the past decade:

#### **Low pressure energy saving membranes**

Low pressure membranes are being widely used to desalt brackish water.

#### **Energy recovery systems**

The energy recovery devices are connected to the concentrate stream as it leaves the pressure vessel. The water in the concentrate stream loses only about 1 to 4 bar (15 to 60 psi) relative to the applied pressure from the high pressure pump.

These energy recovery devices are mechanical and generally consist of turbines or pumps of some type that can transfer pressure energy of RO reject to RO feed.

The pressure required for RO treatment is provided by a high pressure pump. Because of the relatively high energy requirements, most sea water reverse osmosis (SWRO) systems are equipped with an energy recovery device that recovers energy from the pressurised RO concentrate leaving the system. The energy recovery system typically recaptures anywhere from 20 - 50% of the initial pumping energy.

The three most successful energy recovery systems are

- Turbo chargers
- Pelton wheel
- Pressure exchangers

### Turbo Charger

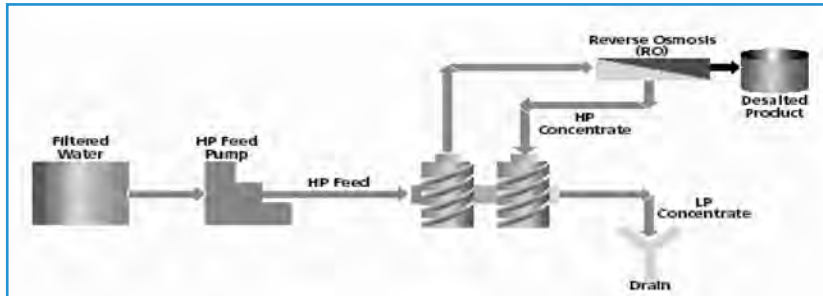

*Fig 11.8 - Process flow diagram of Turbo Charger*

The turbo charger essentially acts like a reverse running pump, where the RO concentrate is used to turn a turbine that is coupled to a pump section with its impeller on the turbine shaft. The energy transfer from the RO concentrate to the RO feed through the turbo charger increases the pressure of the RO feed and thus reduces the external energy requirements for the RO feed. The figure illustrates the typical flow diagram of RO system using a turbo charger for energy recovery.

### Pelton Wheel

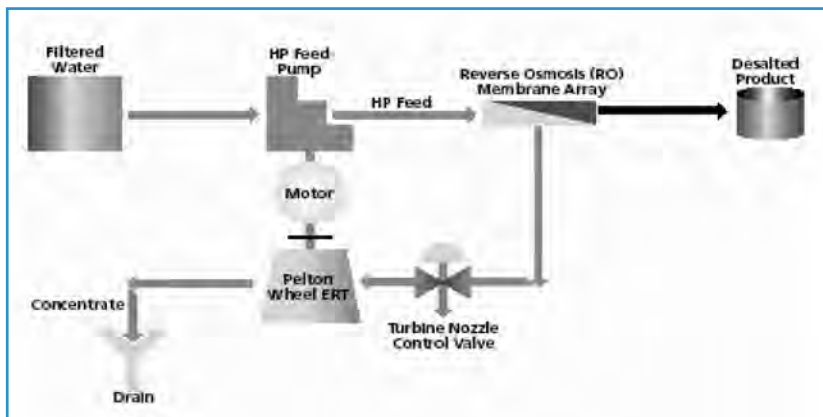
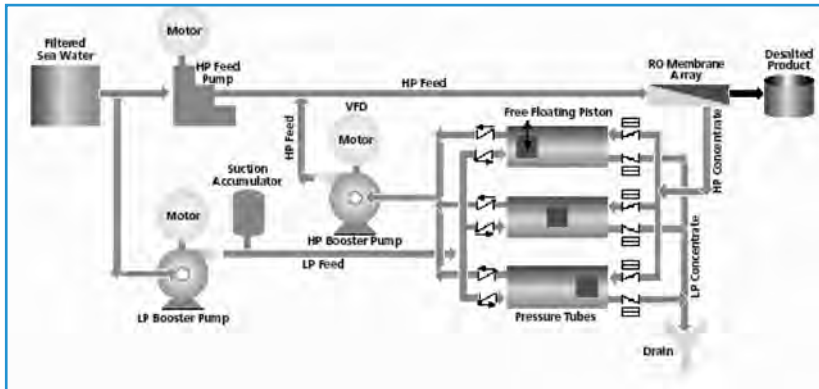

*Fig 11.9 – Process flow diagram of Pelton Wheel*



A nozzle valve is used to direct object of high pressure RO concentrate on to the bucket type blades of Pelton Wheel. This causes the wheel to turn the kinetic energy of the jet into rotating mechanical energy. By coupling the shaft of the Pelton Wheel to the motor or pump, this energy can be used to reduce the electrical energy that is needed to pump the RO feed water. The figure illustrates the process flow diagram of a typical RO system using the Pelton Wheel as energy recovery device.

**Pressure Exchanger**



*Fig 11.10 - Process flow diagram of Pressure Exchanger*

The pressure exchanger uses a system of piston and valves to transfer the pressure of the RO concentrate to part of the RO feed. A high pressure booster pump then pumps the pressurised feed to the required RO feed pressure. The remaining RO feed is pumped by a high pressure pump. The figure illustrates the process flow diagram of a typical RO system using pressure exchanger for energy recovery.

# Chapter 12

## WASTE WATER TREATMENT

**Effluent treatment plant at a steel industry**



**Membrane bioreactor at a construction company**



**Upflow anaerobic sludge blanket (UASB) at a paper industry**



**Zero liquid discharge plant at a synthetic rubber industry**





## 12.0 WASTE WATER TREATMENT

### 12.1 Introduction

Industries consume fresh water for various applications and in turn generate effluents that require to be treated either for safe discharge into the environment or for recovery of water for reuse whenever it is economical.

Based on the process employed by different type of industries, contaminants present in waste waters will vary. Waste water from refineries and petrochemical industries contains predominantly hydrocarbons, oil and grease and organic matter in the form of biological oxygen demand (BOD) and chemical oxygen demand (COD). Effluents from metallurgical and plating industries will contain heavy metals etc.

Industries also generate sewage - almost 80% of water consumed for drinking and sanitation is converted into sewage which needs to be treated for removal of oil and grease, BOD, COD and suspended solids.

Fresh water can be recovered from treated sewage as well and the recovered water can be recycled back into process.

### 12.2 Categories of Effluents

Effluent characteristics vary widely depending on the nature of the industry and hence it is difficult to standardise a treatment scheme applicable to all industries. However it is possible to group the effluents into three broad categories and generally lay down certain guidelines for treatment of effluents. These are:

#### 12.2.1 Low strength effluents

Characterised by TSS less than 100 mg/l, BOD less than 300 mg/l and COD less than 500 mg/l.

The treatment scheme will be oil and grease removal and biological treatment followed by tertiary treatment with possible recovery of water for recycle. Since TDS is not very high it may not need any treatment for removal of TDS.

Options for oil and grease removal are API separator, tilted plate interceptor (TPI) or dissolved air flotation (DAF).

Options for biological treatment are fluidised media reactor (FMR), membrane bioreactor (MBR), activated sludge and extended aeration processes.

Tertiary treatment may consist of disinfection by chlorine or ozone followed by filtration through granular media or activated carbon filters.

### **12.2.2 Medium strength effluents**

Characterised by TSS less than 1000 mg/l, BOD less than 500 mg/l and COD less than 1200 mg/l.

The proposed treatment scheme will be oil and grease removal, primary treatment followed by biological and tertiary treatment, with possible recovery of water for reuse. Equipment for oil removal will be the same as that for low strength effluents.

Options for primary treatment include hopper bottom tank, lamella or solids contact clarifier.

Options for secondary or biological treatment are FMR, MBR, activated sludge, extended aeration or sequential batch reactor.

Options for tertiary treatment include disinfection by chlorine or ozone followed by filtration.

Options for recovery of water are the membrane processes depending upon the quality of treated water required.

### **12.2.3 High strength effluents**

TSS greater than 1000 mg/l, BOD greater than 5000 mg/l and COD greater than 15000 mg/l.

The proposed treatment scheme is oil and grease removal, pretreatment and biological treatment followed by tertiary treatment. Equipment for removal of oil and grease remain the same.

Options for pretreatment will remain the same as that for medium strength effluents

Options for biological treatment will include anaerobic sludge blanket reactor and advanced oxidation processes in addition to those considered for medium strength effluents.

Options for tertiary treatment and for recovery of water will remain the same as that for medium strength effluents.

## 12.3 Heavy Metal Removal

### 12.3.1 Typical heavy metals found in industrial waste water

Heavy metals (as soluble ions) are common contaminants in industrial waste waters. Because of their toxicity to the environment they are typically removed prior to waste water discharge.

The most common heavy metal contaminants are: arsenic, iron, barium, nickel, cadmium, selenium, chromium, silver, copper, zinc and lead.

### 12.3.2 Precipitation of heavy metals

The heavy metal content of waste water can be effectively removed to acceptable levels by precipitating the metal in an insoluble form. Heavy metals are typically precipitated from waste water as:

- Hydroxides
- Sulphides or sometime sulphates
- Carbonates
- Metal co-precipitation during flocculation with iron or aluminium salts is also possible for some metals (e.g. arsenic)

### 12.3.3 Precipitation of heavy metals as hydroxides

Precipitation by hydroxide formation is the most common heavy metal precipitation method. The precipitation typically follows the reaction:

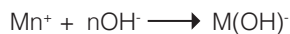

Many heavy metals are amphoteric. Therefore their solubility reaches a minimum at a specific pH (different for each metal).

Addition of caustic materials is used to raise the pH. The most common caustics are:

- Sodium hydroxide (NaOH)
- Calcium hydroxide ( $\text{Ca}(\text{OH})_2$  lime)

Sodium hydroxide is more expensive than lime.

Lime has the advantage of also acting as a coagulant during the precipitation/settling process, whereas NaOH does not.

Lime may react with sulphate in the waste water producing a hard precipitate and resulting in scaling formation.

### 12.3.4 Solubility of metal hydroxides as a function of pH

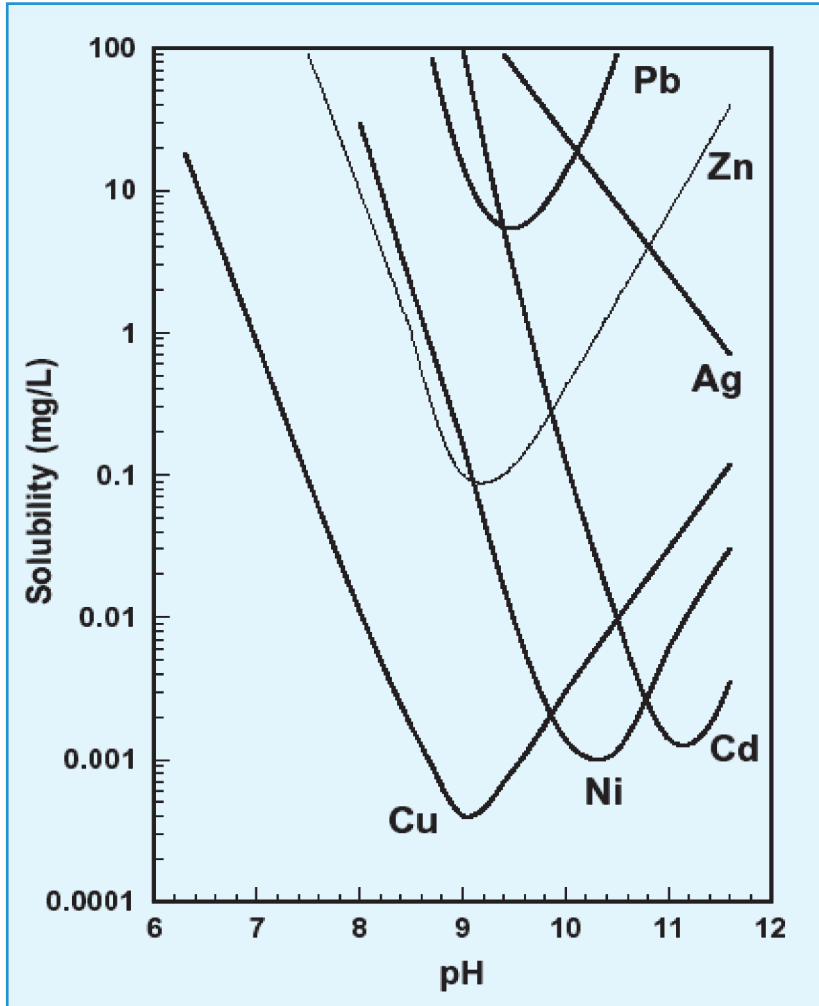

*Fig 12.1 - Solubility of metal hydroxide as a function of pH*

### 12.3.5 Waste water pretreatment prior to metal precipitation

If the waste water contains complexing agents that can keep the metals in solution and prevent them from precipitating, the complexing agent must be destroyed prior to metal precipitation as hydroxides.

This is especially true in the case of cyanide salts because many heavy metals form strong complexes with cyanide. Cyanide is typically removed via oxidation with chlorine under alkaline conditions.

**Solubility of metal sulphides as a function of pH**

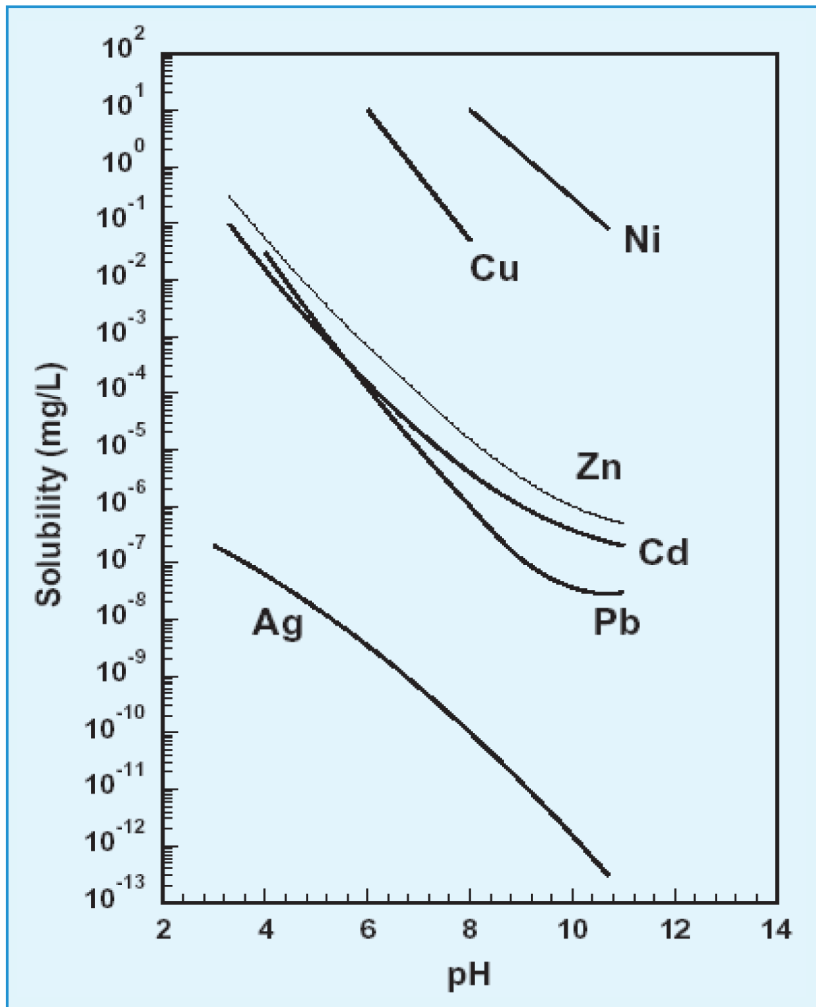

Fig 12.2 - Solubility of metal sulphides as a function of pH



Metal sulphides are typically very insoluble. Therefore metals can be precipitated by adding sulphide ions ( $S^{2-}$ ).

Metal sulphides have much lower solubility than the corresponding metal hydroxides, thus allowing lower residual metal concentrations in the treated waste water.

Hydrogen sulphide ( $H_2S$ ) is a weak acid and dissociates in two steps according to:



Sulphide salts undergo hydrolysis, partially reforming the un-dissociated acid:



$S^{2-}$  is not the dominating species until the pH is very high (~14). Hence, by adding a sulphide salt equilibrium is generated, resulting in only the partial formation of the  $S^{2-}$  ions actually used in precipitation.

Sulphide precipitation is always conducted under alkaline conditions to promote sulphide ion formation.

Sulphide precipitation is rather insensitive to the presence of chelating agents.

Sulphide precipitates tend to form colloidal particles requiring the addition of coagulants to settle. However, sulphide sludge is easier to dewater than hydroxide sludge.

Sulphide sludge is more prone to oxidation resulting in re-solubilisation of the metals as sulphates.

Evolution of  $H_2S$  is a potential hazard if the pH is not carefully maintained in the alkaline region.

## 12.4 Processes for Removal of Oil (Hydrocarbons) from Industrial Effluents

### 12.4.1 API oil separator

An API oil-water separator is a device designed to separate gross amounts of oil and suspended solids from the waste water effluents of oil refineries, petrochemical plants, chemical plants, natural gas processing

plants and other industrial sources. The name is derived from the fact that such separators are designed according to standards published by the American Petroleum Institute (API).

The API separator is a gravity separation device designed by using Stokes Law to define the rise velocity of oil droplets based on their density and size. The design of the separator is based on the specific gravity difference between the oil and the waste water because that difference is much smaller than the specific gravity difference between the suspended solids and water. Based on that design criterion, most of the suspended solids will settle to the bottom of the separator as a sediment layer, the oil will rise to top of the separator, and the waste water will be the middle layer between the oil on top and the solids on the bottom.

Typically, the oil layer is skimmed off and subsequently re-processed or disposed of, and the bottom sediment layer is removed by a chain and flight scraper (or similar device) and a sludge pump. The water layer is sent to further treatment consisting usually of a dissolved air flotation (DAF) unit for further removal of any residual oil and then to some type of biological treatment unit for removal of undesirable dissolved chemical compounds.

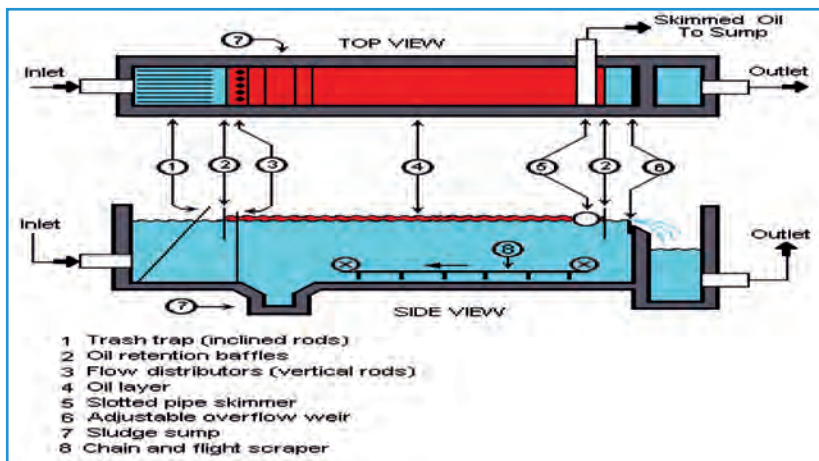

*Fig 12.3 - A typical gravimetric API separator*

### 12.4.2 Parallel plate separator

Parallel plate separators are similar to API separators but they include tilted parallel plate assemblies (also known as parallel packs). The underside of each parallel plate provides more surfaces for suspended oil droplets to coalesce into larger globules. Any sediment slides down the topside of each parallel plate. Such separators still depend upon the difference in specific gravity between the suspended oil and the water. However, the parallel plates enhance the degree of oil-water separation. The result is that a parallel plate separator requires significantly less space than a conventional API separator to achieve the same degree of separation.

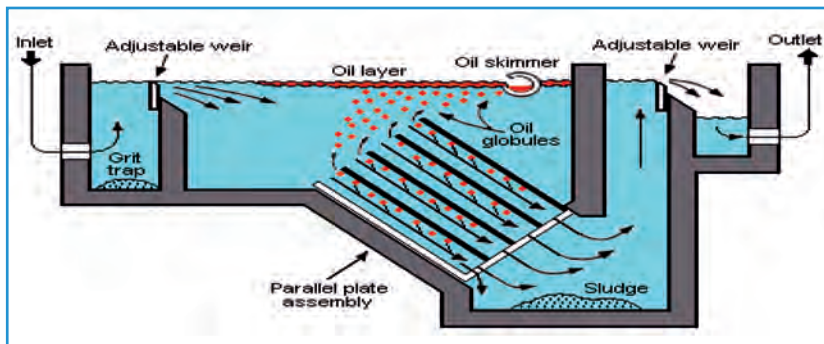

*Fig 12.4 - Typical parallel plate separator*

### 12.4.3 TPI oil separator

The corrugated plate pack in a TPI (tilted plate interceptor)/CPI (corrugated plate interceptor) separator, used in oily water treatment for removal of free oil, is the heart of our various purification systems consisting of number of parallel corrugated plates. A plate pack is a housing of flat plastic plates (strengthened by resins) and stiffened by a frame made from plastic material (strengthened by resins) and/or stainless steel.

The number of plates per plate pack is also factored to a certain extent on economy of size of the separator. The number of plate packs per TPI/CPI separator is calculated based on the effluent flow and its characteristics to the unit.

The liquid to be treated flows through the spaces between the corrugated plates in each plate pack. Ideal condition for separation is achieved in the TPI/CPI separator by simulating a laminar flow condition through the plate pack.

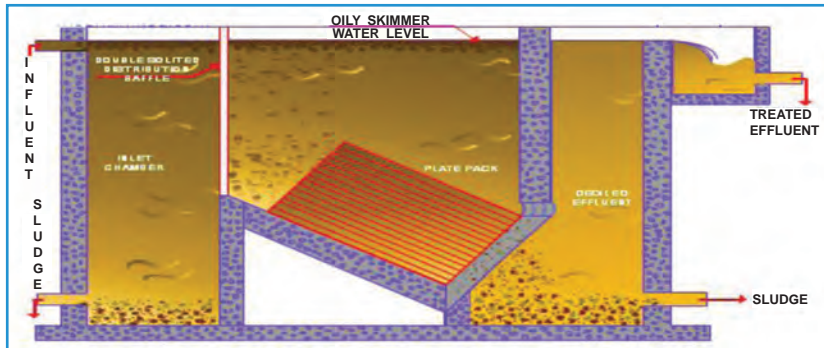

Fig 12.5 - A typical TPI oil separator

### Comparison of TPI vs API Oil Separator

Sr. No.	Feature	TPI Unit	API Unit
1.	Space Requirement	Low (~20 % of API Unit)	High
2.	Power Consumption	Nil	Yes
3.	Moving Parts	Nil	Yes
4.	Wear & Tear	Nil	Yes
5.	Maintenance	Nil	High
6.	Oil Removal Efficiency	Very High	High
7.	Min. Oil Removal Globule Size	50 Micron	150 Micron
8.	Susceptibility to Shock Oil Loads	No	Yes
9.	Susceptibility to Shock Hydraulics Loads	Marginal	High
10.	Ease of Construction	Yes as Prefabricated Construction	No
11.	Ease of Installation	Yes	No
12.	Future Expansion	Very easy by adding plate pack modules	Not possible as new unit has to be installed
13.	Requirement of Spares	No	Yes
14.	Cost of Unit	Low	High
15.	Downtime due to Maintenance	No	Yes

#### 12.4.4 Dissolved air flotation

Dissolved air flotation (DAF) is a treatment process that clarifies waste waters (or other waters) by the removal of suspended matter such as oil or solids. The removal is achieved by dissolving air in the water or waste water under pressure and then releasing the air at atmospheric pressure in a flotation tank or basin. The released air forms tiny bubbles which adhere to the suspended matter causing the suspended matter to float to the surface of the water where it may then be removed by a skimming device.

Dissolved air flotation is very widely used in treating the industrial waste water effluents from oil refineries, petrochemical and chemical plants, natural gas processing plants, paper mills, general water treatment and similar industrial facilities.

The feed water to the DAF float tank is often (but not always) dosed with a coagulant (such as ferric chloride or aluminum sulphate) to flocculate the suspended matter.

A portion of the clarified effluent water leaving the DAF tank is pumped into a small pressure vessel (called the air drum) into which compressed air is also introduced. This results in saturating the pressurised effluent water with air. The air-saturated water stream is recycled to the front of the float tank and flows through a pressure reduction valve just as it enters the front of the float tank, which results in the air being released in the form of tiny bubbles. The bubbles adhere to the suspended matter, causing the suspended matter to float to the surface and form a froth layer which is then removed by a skimmer. The froth-free water exits the float tank as the clarified effluent from the DAF unit.

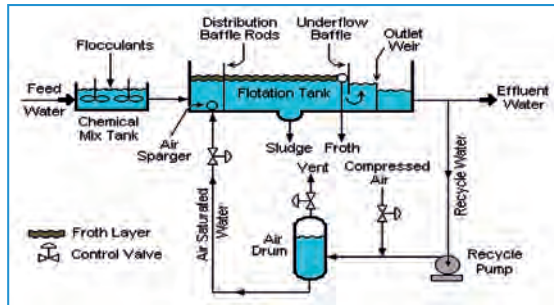

*Fig 12.6 – A typical dissolved air flotation unit*

Some DAF unit designs utilise parallel plate packing material, lamellas, to provide more separation surface and therefore to enhance the separation efficiency of the unit.

DAF systems can be categorised as circular (more efficient) and rectangular (more residence time). The former type requires just 3 minutes. The rectangular type requires 20 to 30 minutes. One of the bigger advantages of the circular type is its spiral scoop.

### 12.4.5 Oil coalescer

The use of oleophilic **INDION** OCR resin material in the coalescing process for the separation of emulsified oil from water is the basis of the double step coalescer technology. This system is specifically designed to treat steam condensate streams in order to remove emulsified oil contamination and to make them suitable for recovery. The coalescer filter is a vertical upflow pressure filter. The de-oiling process consists of filtering the oily water stream through two separate coalescing zones.

In the primary coalescing zone, the separation of the emulsified oil droplets from the water stream occurs on the surface of the resin beads, where a thin oil film is formed during the process, due to the special characteristics of the resin material. When the oil film thickness increases, the coalesced oil migrates upward within the resin layer.

As a consequence, the upper layer of the resin bed is always almost saturated with oil, so that it releases the coalesced oil in form of larger droplets which move upward, towards the secondary coalescing zone.

The secondary coalescing zone is fitted with a coarser oleophilic media having the function to aggregate the oil droplets coming from the primary zone into larger oil drops which are made free to move upward to the top of the vessel, where the free oil can be removed practically free of water.

A differential pressure indicator across the primary coalescing zone shows the clogging of the resin layer due to the suspended solids is removed from the treated water and trapped on the resin supporting net. When the pressure drop exceeds a given figure, a backwash is required.

Experience teaches that when de-oiling condensate water, the solids content in the influent stream is so little that backwashing is very seldom required (every several months) and the coalescing process really becomes a continuous process, with practically no interruption of the service.

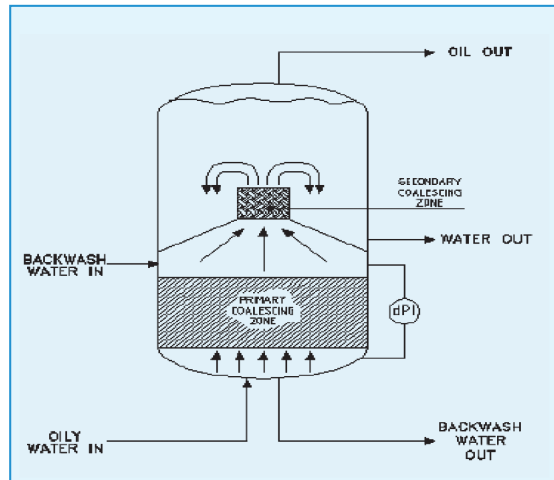

*Fig 12.7 - A typical oil coalescer unit*

In such a condition the resin has a life of more than five years and can operate continuously at a temperature up to 100° C. Higher temperature such as 120° C can be accepted for limited time (few hours).

#### 12.4.6 Rotating oil drum skimmer

##### Operations

The hydrocarbon recovery drum skimmer consists of a cylinder covered with oleophilic skin.

The device, continually rotating on the surface of the water, selectively picks up the hydrocarbons which are then recovered by stationary scraper in a collecting trough.

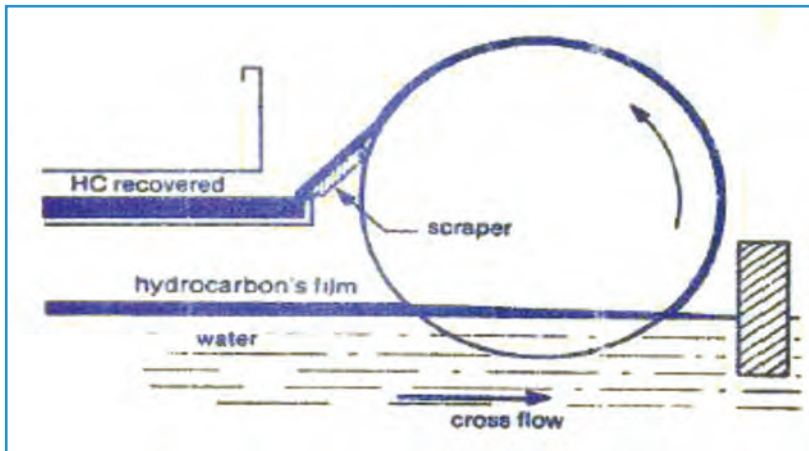

Fig 12.8 - Rotating oil drum skimmer

##### Advantages

- Continuous recovery of the decanted oil gives reduced evaporation losses at the surface of the separator
- Selective recovery of the decanted hydrocarbons allows to reduce the percentage of water in the slops (by manual intervention, this percentage is between 60% to 95%, average 90%) and thus reduces dehydration costs
- Recovery of auto combustible slops
- Simple device requiring no modification of existing separators
- Automatic, reducing operating cost

## 12.5 Treatment of Sewage

### 12.5.1 Packaged sewage treatment plant

#### Primary settlement

The plant is designed for receiving raw sewage and settling the gross solids without recourse to mechanical means. It incorporates lamella plates or parallel plates to enhance efficiency and utilisation of space. The primary settlement zone reduces the suspended solids by 75% and the BOD by 25% to 30%. This zone is relatively maintenance free and contains no moving mechanical or electrical devices. Lockable covers with easy man access and sufficient ventilation are provided. The re-circulation from the aerator and the return of humus sludge into the primary settlement zone inhibits the settled effluent from becoming anaerobic, which prevents bad odour.

#### Aerobic treatment

The settled sewage is treated by means of an efficient and compact system (the aerator bio-zone) requiring minimal power input and maintenance. It is a combined fixed film reactor and active aeration system mounted on a horizontal shaft. The rotational media is a spiral formation enclosed in an outer drum to provide active aeration, intense surface area and net hydraulic lift. The bio-zone is self-cleansing and no extraneous pumping or sludge returns are required. For process efficiency it is, in effect, a plug flow system.

#### Final settlement

The final settlement or humus tank is a discrete compartment denying ingress of untreated or partially treated liquor. The design is similar to the primary settlement tank on an upward flow basis.

#### Features

- All in one single tank package sewage treatment plant
- Modular design 2642 - 26417 gallons/day
- Compact and simple to operate
- High quality effluent
- Three month sludge storage capacity
- Minimal maintenance
- GRP construction tank, so no corrosion



### Advantages

- Minimum land usage
- Minimum power and chemical requirement
- Low operating cost

## 12.5.2 Fluidised media reactor (FMR)

### Process

In the **INDION** FMR, raw sewage enters at the top of the tank. In the aeration zone, air is introduced at the bottom of the tank through fine bubble diffusers. The media will be in suspension due to the turbulence created by the air. Bacteria required for oxidation of the organic matter are attached to the media and some suspended in the tank. After oxidation, the bacteria grow in number and need to be separated from the aeration tank liquor.

The lamella section inside the settling zone helps for clarification and separation of biomass (sludge) and clear water overflow into the chlorine contact tank. Lamella plates help in increasing the settling area and removing the particles effectively in a smaller plant area. In the chlorine contact tank, sodium hypochlorite (NaOCl) is added to disinfect the clarified sewage. Baffles are provided to increase contact time of treated sewage with chlorine.

Valves are used for sludge removal as well as MLSS (mother liquor suspended solids) adjustment. The chlorinated, treated sewage then flows out of the **INDION** FMR either for further treatment or for disposal.

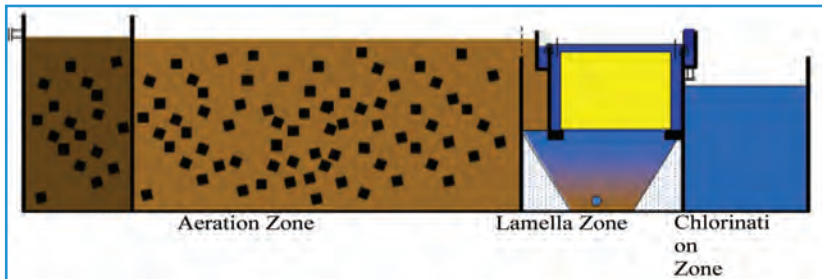

Fig 12.9 - Schematic of fluidised media reactor

**Features**

- Single tank design
- 1/3 space of conventional sewage treatment plant
- Uses high porosity moving media for bacteria to grow
- Useful for modification/capacity extension of existing sewage treatment plants.

**Advantages**

- Minimum land usage
- Minimum power and chemical requirement
- Low operating cost

**12.5.3 Membrane bioreactor (MBR)**

**Process**

It is among the latest technologies in biological treatment, designed to produce high quality treated water from waste water with highest possible contamination reduction without using any chemicals.

What makes MBR so successful is the effectiveness of the submerged membrane filtration in the biological process. It is this membrane treatment that produces high quality permeates from domestic sewage and industrial waste water. The submerged membranes used in the biological process remove suspended matter from activated sludge, and provide a stable and reliable unit with consistent performance.

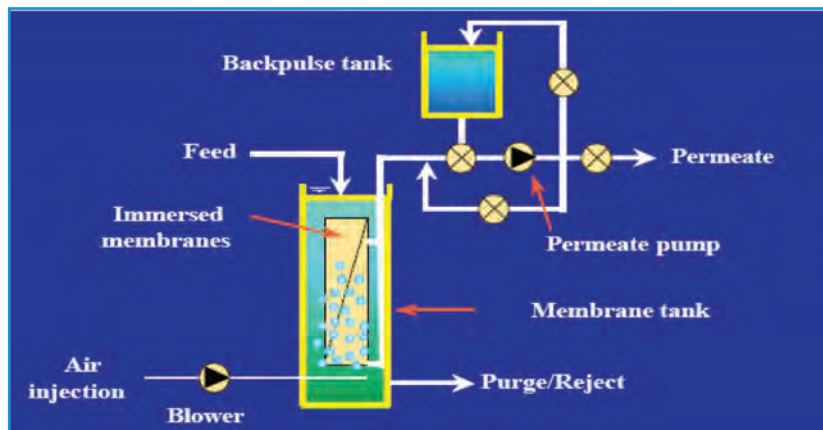

*Fig 12.10 - Schematic of membrane bioreactor*

**Features**

- Single packaged unit with minimal civil construction
- Modular in construction and design
- Compact, requires 25% of a conventional system
- Low energy consumption (1.14 kwh/1,000 gallons) for filtration
- Up to 99.9999% removal of total coliform
- No chemicals required during treatment

**Advantages**

- Minimum land usage
- Minimum power and chemical requirement
- Low operating cost

**12.6 Anaerobic Processes**

Anaerobic digestion is a biological process that uses bacteria that live and reproduce in an environment containing no free or dissolved oxygen, to treat sludge that is a by-product of the waste water treatment process.

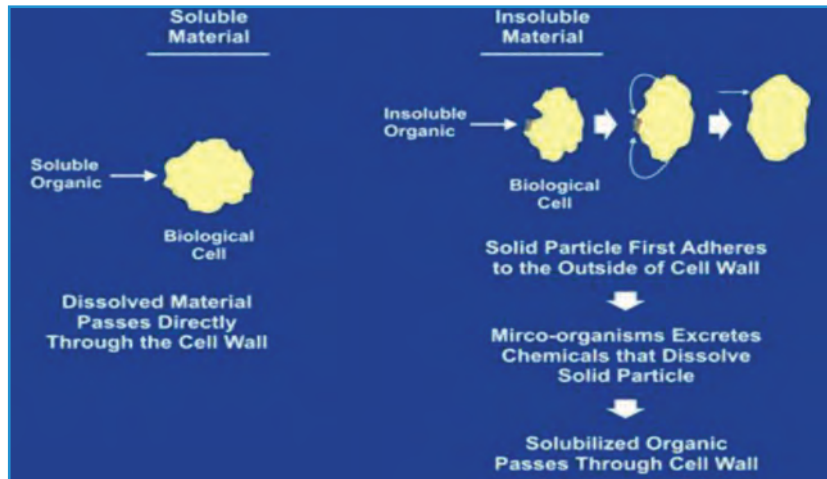

Fig 12.11 - Soluble and insoluble material

### **Functions of anaerobic digestion**

- Breaking down organic matter into simple compounds
- Minimising further biological activity
- Transforming portions of solids into liquid and gas
- Reducing the sludge solids to be dewatered
- Producing methane gas (CH<sub>4</sub>) for fuel
- Eliminating some pathogenic bacteria
- Reducing sludge odours

### **Anaerobic sludge digestion steps**

- First complex organic compounds are converted into soluble forms
- Second complex soluble organic matter is changed to volatile (organic) acid
- Third organic acids are broken down by a different type of microorganisms to form methane gas, but at much slower rate

### **Microbes are grouped into acid formers and methane formers.**

#### **Acid formers**

- Convert soluble organic solids to organic acid
- Enzymes break down insoluble organics to soluble organics
- High energy, rapid growing
- Not as sensitive to environmental changes

#### **Methane formers**

- In a balanced system organic acids are consumed at the same rate as produced
- Get little energy from the organic acid
- Grow slowly compared to acid formers
- Susceptible to pH and temperature changes
- Do the work of stabilisation

#### **Transfer mechanism**

Insoluble organics are broken down to soluble organics by enzymes. Acid forming bacteria convert soluble organic solids to organic acids matter into organic acids. Methane forming bacteria act on the organic acids and convert them to carbon dioxide (CO<sub>2</sub>) and methane (CH<sub>4</sub>).

## By-products of digestion

### Digested sludge

This consists of inorganic solids and volatile solids that are not easily digested.

### Production of gases

Methane (65% to 70%) for fuel, carbon dioxide (30% to 35%) and lesser gases hydrogen sulphide etc.

### Operating parameters

Parameters	Approximate value
Alkalinity	2000 to 5000 mg/l (as CaCO <sub>3</sub> )
Volatile acid	50 to 300 mg/l (< 500 mg/l)
VA/Alkalinity ratio	0.1 to 0.35
pH	6.6 to 7.2
Temperature	93 to 100° F
Carbon dioxide in gas	30% to 35% by volume
Methane in gas	65% to 70% by volume

## 12.7 Aerobic Processes

Aerobic means with air or oxygen. Aerobic bacteria are a higher life form and, when digesting waste, are utilising dissolved oxygen or air in the waste water.

An 'aerobic activated sludge' process takes place in an oxygen enriched environment. The treatment of the waste happens within a few short hours as compared to a septic process using anaerobic digestion, which can be in the order of 70 to 90 days, depending on temperature.

Aerobic digestion has two main phases within the treatment cycle:

1. Aerobic digestion is called activated sludge which is formed through aeration of the incoming sewage where it is mixed with the previously grown deposit of so called humus known as a bacterial biomass, where digestion of organic matter and ammonia takes place.
2. The bacterial biomass quite readily flocculates and settles in a quiet zone where the solids are retained after settling and the clear water is removed by decanting. The settled solids stay within the system, to become mixed with the new incoming sewage to be digested and oxidised through continuous never ending cycles of aeration in an oxygen enriched environment within the treatment system.

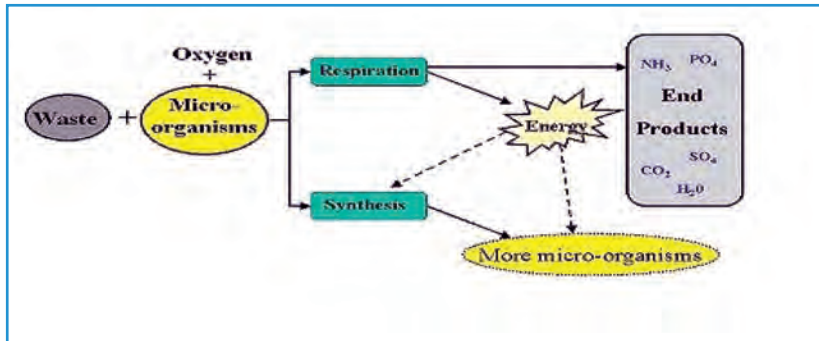

Fig 12.12 - Path of aerobic digestion

An activated sludge biomass that has been established for a period greater than 5 days develops sufficient aerobic bacteria to digest ammonia and other organic nitrogen to nitrates. During the 'off' periods of cycled aeration where the dissolved oxygen is depleted, an anoxic environment becomes part of the process. This causes the aerobic bacteria to respire on nitrates during this period, which converts them to free nitrogen.

Activated sludge process is amenable for control of several important operating parameters which can be tuned to a particular application. As the digestion and oxidation of the waste is more efficient, there is little or no de-sludging required except under extreme heavy load conditions. Oxidation processes convert all organic matter to simple carbon compounds, gases, and water.

Naturally occurring aerobic bacteria are more aggressive and, driven with the energy of dissolved oxygen in an aerobic chamber, offer a far more effective and efficient treatment process, where rapid digestion of the waste takes place in a relatively smaller vessel.

## 12.8 Some of the Specific Contrasts Between Aerobic and Anaerobic Treatment

### 12.8.1 Temperature

Temperature affects both aerobic and anaerobic reactions, but the anaerobic process requires a higher operating temperature than the aerobic process in order to obtain a practically applicable reaction rate. Available data indicate that 10° C reduction in temperature reduces both aerobic and anaerobic reactions rates by a factor of two. Loss of

treatment efficiency, in both the aerobic and the anaerobic processes, due to temperature reduction may be compensated by increasing the biomass. The anaerobic process can often cost effectively use biogas generated by the process to heat the reactor and maintain performance efficiency.

### **12.8.2 pH and alkalinity**

Aerobic process operates most effectively over a range of pH 6.5 to 8.5. In most instances, a completely mixed activated sludge system is a self neutralising process, in that caustic alkalinity reacts with  $\text{CO}_2$  generated by the biological reaction and yields bicarbonate. Volatile acids biodegrade to  $\text{CO}_2$  and  $\text{H}_2\text{O}$  is then stripped from the reactor. No external neutralisation is typically required as long as the effluent BOD is less than 25 mg/l.

In the anaerobic process, the methanogenic bacteria are pH sensitive and generally have an optimum range of pH 6.5 to 7.5. It is especially important for the methano-bacteria to maintain at least pH 6.2 in the system. If moderate levels of sulphates are present, then it is preferable to maintain a pH of 7 to 8 to avoid hydrogen sulphide toxicity problems. It is desirable to have bicarbonate alkalinity in the range of 2,500 to 5,000 mg/l in order to provide buffer capacity to handle volatile acid increases with a minimal decrease in pH. Alkalinity and pH are often controlled by adding bicarbonate to the reactor.

### **12.8.3 Excess sludge production and nutrient requirements**

For most waste waters, the net sludge yield from aerobic activated sludge treatment is in the order of 0.5 kg VSS/Kg of COD removed. By contrast the sludge yield from anaerobic treatment is approximately 0.1 kg VSS/kg COD removed. Anaerobic bacteria contain approximately the same cell composition as all other types of bacteria. Hence, nutrients are required in the same proportions in anaerobic and aerobic systems to enable good cell growth. The difference is that cell production is less in anaerobic systems and nutrient requirements are therefore proportionately less. Nitrogen and phosphorous quantities added to the system need to be approximately 5% and 1%, respectively, of the change in total cell mass. As a thumb rule, anaerobic waste sludge production and nutrient requirements will be about one-fifth those of aerobic processes.

### 12.8.4 Comparison of aerobic and anaerobic treatment

Parameters	Anaerobic	Aerobic
Energy requirements	Low	High
Degree of treatment	Moderate (60 to 90%)	High (95%+)
Sludge production	Low	High
Process stability (to toxic compounds and load change)	Low to moderate	Moderate to high
Start up time	2 to 4 months	2 to 4 weeks
Nutrient requirements	Low	High for certain industrial wastes
Odour	Potential odour problems	Less opportunity for odour
Alkalinity requirements	High for certain industrial wastes	Low
Biogas production	Yes	No





## ANNEXURES



# ANNEXURE - 1

## WATER ANALYSIS REPORT

The water analysis report contains the following information

Client  
 Sampling Date  
 Source

Parameter	Unit
Colour	Hazen
Odour	-
Taste	mg/l
Suspended Solids	mg/l
Turbidity	NTU
pH	
P-Alkalinity	mg/l CaCO <sub>3</sub>
M-Alkalinity	mg/l CaCO <sub>3</sub>
Equivalent Mineral Acidity	mg/l CaCO <sub>3</sub>
Chloride	mg/l CaCO <sub>3</sub>
Sulphate	mg/l CaCO <sub>3</sub>
Nitrates	mg/l CaCO <sub>3</sub>
Fluoride	mg/l CaCO <sub>3</sub>
Total Hardness	mg/l CaCO <sub>3</sub>
Calcium	mg/l CaCO <sub>3</sub>
Magnesium	mg/l CaCO <sub>3</sub>
Sodium	mg/l CaCO <sub>3</sub>
Iron	mg/l Fe
Silica	mg/l SiO <sub>2</sub>
Total Dissolved Solids	mg/l
Conductivity @25°C	µS/cm
Oxygen Absorbed (OA)	mg/l
Chemical Oxygen Demand	mg/l
Biochemical Oxygen Demand	mg/l
Total Organic Carbon	mg/l

## ANNEXURE - 2

### DETERMINATION OF BICARBONATES, CARBONATES AND HYDROXIDES

Take a 100 ml sample of water in a beaker and add phenolphthalein indicator. If carbonates and/or hydroxides are present it will develop a yellow colour. Titrate the solution against a 0.1 N hydrochloric acid till the solution turns colourless. Record the burette reading (say 0.5 ml). To the same sample add methyl orange indicator and titrate till the solution changes from pink to blue colour. Record the reading (say 3 ml).

Carbonates =  $2p = 0.5 \text{ ml} \times 2 = 1 \text{ meq/ml} = 50 \text{ mg/l as CaCO}_3$

Total alkalinity = 3 ml = 3 meq/ml = 150 mg/l as  $\text{CaCO}_3$ . Water contains (150 - 50) or 100 mg/l bicarbonates and 50 mg/l carbonates.

The table below helps in finding out the quantity of hydroxides, carbonates and bicarbonates present.

#### Alkalinity Relationship

	Bicarbonates	Carbonates	Hydroxides
P AIK = 0	M ALK		
P-AIK < M-AIK/2	M ALK - 2 P AIK	2 P AIK	
P-AIK = M-AIK/2		M ALK	
P-AIK > M-AIK/2		2 (M-AIK-P AIK)	2 P AIK - M ALK
P AIK = M AIK			M ALK

## ANNEXURE - 3

### UNITS OF CONCENTRATION

#### Volumetric concentration

This is a measure of the quantity of matter dissolved or dispersed in a given volume of water.

It is indicated as mg/l, g/l, g/m<sup>3</sup>, kg/m<sup>3</sup>.

Also expressed in percentage form as % w/v, x% w/v means x kg of pure substance are present in 100 litres of solution.

Milli equivalent per litre (meq/l)

Equivalent per litre (eq/l)

$$\text{meq/l} = \frac{\text{mg/l}}{\text{equivalent weight}}$$

$$\text{equivalent weight} = \frac{\text{atomic weight or molecular weight}}{\text{number of charges of same sign or valency}}$$

In water treatment it is customary to express concentration of all ions as mg/l CaCO<sub>3</sub> for convenience. Molecular weight of CaCO<sub>3</sub> is 100 and its valency is 2. Its equivalent weight is 100/2 or 50.

$$\text{ppm CaCO}_3 = \frac{\text{mg/l of element}}{\text{equivalent weight of element}} \times 50$$

$$\begin{aligned} 1 \text{ English degree} &= 1 \text{ grain/gal} \\ &= 14.38 \text{ ppm CaCO}_3 \end{aligned}$$

For example, molecular weight of calcium is 40 and it has a valency of 2. Hence, its equivalent weight is 20. If concentration of Ca is mentioned as 80 mg/l as Ca, this is equal to 80/20 or 4 meq/l.

To get concentration in terms of CaCO<sub>3</sub>, multiply this value by 50, the answer is 4x50 or 200 mg/l as CaCO<sub>3</sub>.

### **Weight concentration**

This is the quantity dissolved or dispersed in a given weight of water.

It is indicated as mg/kg, g/t or ppm (parts per million).

As density of water is 1 kg/l, the ppm is synonymous with mg/l.

Also expressed in percentage form as % w/w.

x% w/w means - x kg pure substance are present in 100 kg of solution.

### **Useful relationships**

#### **Concentrations of ions must be expressed as mg/l CaCO<sub>3</sub>**

Total Cations (TC) = Total Anions (TA)

(Silica is not considered as it is only very weakly dissociated in water. Strong base resins, due to their high basicity, remove silica and hence it is considered as a load on strong base resin).

TA = M-alkalinity + EMA where EMA = Cl+SO<sub>4</sub>+NO<sub>3</sub>+F

Total Hardness (TH) = Ca+Mg

Sodium (Na<sup>+</sup>) = TC-TH

Temporary Hardness = M Alk if TH > M Alk

TH if TH < M Alk

Permanent Hardness = TH - M Alk

Sodium Alkalinity = M Alk - TH

## ANNEXURE - 4

### DETERMINATION OF OPERATING EXCHANGE CAPACITY

Name of the resin	Type of resin	Ionic form for testing	Process application	Regene-rant used	Ionic load for capacity	Break-through point	Treated water is analysed for
INDION 236	WAC	H	Dealkalisation	HCl dilute	M-Alk.	30 mg/l M-Alk.	M-Alk.
INDION 652	WAC	H	Dealkalisation	HCl dilute	M-Alk.	30 mg/l M-Alk.	M-Alk.
INDION 225 H	SAC	H	Deionisation	HCl dilute	Total Cation	1 ppm as Na	Sodium
INDION 225 Na	SAC	Na	Softening	NaCl, 10%	Total hardness (T.H.)	10 ppm T.H.	T.H.
INDION 220 Na	SAC	Na	Softening	NaCl, 10%	Total Hardness (T.H.)	10 ppm T.H.	T.H.
INDION 850	WBA	FBF	Removal of Mineral acidity	NaOH dilute	EMA	5 ppm Cl	Chloride
INDION 860	WBA	FBF		NaOH dilute	EMA	5 ppm Cl	Chloride
INDION TWB	WBA	FBF		NaOH dilute	EMA	5 ppm Cl	Chloride
INDION FFP	SBA-I	Cl	Deionisation	NaOH dilute	Total Anion + SiO <sub>2</sub>	0.2 ppm SiO <sub>2</sub>	Silica (as SiO <sub>2</sub> )
INDION 810	SBA-I	Cl	Deionisation	NaOH dilute	Total Anion + SiO <sub>2</sub>	0.2 ppm SiO <sub>2</sub>	Silica (as SiO <sub>2</sub> )
INDION GS 300	SBA-I	Cl	Deionisation	NaOH dilute	Total Anion + SiO <sub>2</sub>	0.2 ppm SiO <sub>2</sub>	Silica (as SiO <sub>2</sub> )
INDION NIP	SBA-II	Cl	Deionisation	NaOH dilute	Total Anion + SiO <sub>2</sub>	0.5 ppm SiO <sub>2</sub>	Silica (as SiO <sub>2</sub> )
INDION 820M	SBA-II	Cl	Deionisation	NaOH dilute	Total Anion + SiO <sub>2</sub>	0.5 ppm SiO <sub>2</sub>	Silica (as SiO <sub>2</sub> )
INDION GS 300	SBA-II	Cl	Deionisation	NaOH dilute	Total Anion + SiO <sub>2</sub>	0.5 ppm SiO <sub>2</sub>	Silica (as SiO <sub>2</sub> )
INDION 830	Org. Scav.	Cl	Organic removal	NaCl, 10%	KMnO <sub>4</sub> , V or TOC	KMnO <sub>4</sub> , V or TOC	KMnO <sub>4</sub> /TOC
INDION BSR	Chela-ting	Na	Brine softening	HCl & NaOH	Total Hardness	20 ppb Ca + Mg	T.H.
INDION MSR	Chela-ting	SH	Hg removal	HCl conc.	Mercury	0.01 ppm Hg	Mercury
INDION SIR	Chela-ting	Na	Metal removal	HCl + NaOH	Specific Metal	as specified	Metal impurity



## ANNEXURE - 5

### GUIDELINES FOR TROUBLESHOOTING AND MAINTENANCE OF ION EXCHANGE UNITS

#### 1.0 Troubleshooting

Sr. No	Defects	Causes	Remedies
1	Decrease in capacity between two successive regenerations	a) Flow instrument defective	Check
		b) Plant being used intermittently	Avoid this
		c) Insufficient chemicals used	Check
		d) Increase in ionic load	Check analysis
		e) Resin quantity insufficient in the unit	Check and top up
		f) Channeling in bed	Check and ensure uniform distribution / collection
		g) Resin dirty	Give prolonged backwash
		h) Resin fouled	If cation resin give hydrochloric acid wash and if anion resin give alkaline brine treatment
		i) Resin deteriorated	Check and replace charge
2	Treated quality not up to the standard	a) Cation exhausted	Check
		b) Anion exhausted	Check
		c) Mixed bed exhausted	Check
		d) MB resin not in uniform mixed state	Repeat air mix and rinse
		e) Some valves like backwashing leaking	Check
		f) Sodium slip from cation is high	Check raw water analysis, Change in Na/TC and SiO <sub>2</sub> /TA ratio. Use more chemicals
		g) SiO <sub>2</sub> slip from anion unit is high	
		h) Unit idle	Check
		i) Unit not sufficiently rinsed	Rinse to satisfactory quality
		j) Excessive/low flow rate	Adjust to between unit min/ max flow rate
		k) Channeling	Check and ensure uniform collection/distribution
		l) Resin fouled	Check resin and give alkaline brine/HCl treatment
		m) Resin deteriorated	Check resin and replace

Sr. No	Defects	Causes	Remedies
3.	Mixed bed quality not good	a) Resin not separated properly during backwash	Give extended backwash after exhausting the bed
		b) Air mix not proper	Repeat
		c) Final rinse not proper	Repeat
		d) Some valves may be leaking and contaminating the treated water	Check and examine
4	Unit rinse take long time	a) Flow rate too low	Increase the flow rate
		b) Unit exhausted	Regenerate the unit
		c) Backwash valve passing	Check and rectify
		d) Anion resin organically fouled	Give alkaline brine treatment
		e) Mixed bed air mix not satisfactory	Carry out air mix once again
		f) Acid/alkali pockets formed in the unit	Faulty design, check and rectify. Temporarily backwash (followed by air scour of MB) and rinse again
5	Flow rate too low	a) Choked valve and suction strainer of pump	Check
		b) Cavitation in the pump	Check
		c) Low inlet pressure	Check pump
		d) Distribution or collection system choked	Check
		e) Resin trap at outlet choked	Check and clean
		f) Control valve shut due to low off-take	Increase off-take
6	Pressure drop across the bed increasing	a) Pressure guage defective	Check and rectify / replace
		b) Defective valves	Check
		c) Packed resin bed and resin fines	Give extended backwash with open manhole and scrape off fines from top surface of the resin
		d) Collecting system choked	Check, repeat backwash
7.	Resin being lost from unit	a) Excessive backwash pressure	Check inlet pressure and reduce if necessary
		b) Faulty collecting system	Examine same for breakage
		c) Inlet strainer damaged	Check and replace
8	Ejector not working	a) Low power water	Check this pressure
		b) Air lock in the unit	Backwash and open air release
		c) Choked or defective valves	Examine and rectify
		d) Ejector nozzle choked	Check
		e) Too much back pressure from the unit	Check for choking of collecting system, passage of inlet/outlet valves
		f) Bulge in pipe rubber lining	Check and rectify

Sr. No	Defects	Causes	Remedies
9	Incorrect reading from rotameters	a) Choked orifice, sub orifice or impulse lines	Check and clean
		b) Dirty glass and float	Check and clean
		c) Float corroded	Check and replace
		d) Instrument not calibrated	Recalibrate
10	Improper reading from flow indicator/totaliser	a) Choked impulse lines/orifice	Check and clean
		b) DP Transmitter requires calibration	Recalibrate
		c) Leakage in signal between transmitter and panel	Check
11	Improper opening and closing of pneumatically operated valves	a) Defective solenoid valves	Check
		b) Leakage in air line from solenoid valve to the respective control valve	Check
		c) Improper contact of micro switch giving false indication to panel	Check

## 2.0 Maintenance

### 2.1 General maintenance

The water treatment plant should be inspected externally every six months and any damaged paintwork on vessels, pipework and valves renewed.

An internal inspection of vessels is also recommended every six months, although this period could be extended if service experience indicates that a longer period would not jeopardise the performance.

When carrying out external examination of pipework, valves and vessels bear in mind that evidence of external corrosion may be due to underlying causes such as a damaged lining in a vessel or pipe subjected to hydrochloric acid or caustic soda.

Consequently when removing scale on such items (e.g. bulk storage tanks, measuring tanks) exercise caution. If there is any possibility of a breakthrough consult the water treatment plant chemist or engineer. If the internal and external inspections are carried out systematically at regular intervals, and a record kept of any work carried out, there will be little likelihood of the unexpected happening.

In addition, rectify leaking valves and joints immediately by tightening nuts and bolts or changing sealing joints (gasket). Replace gland packing when required. Don't let leaks persist. Keep the water treatment plant dry and well swept.

If it is necessary for maintenance personnel to enter any of the treatment units, rubber or soft soled shoes must be worn and great care taken to avoid damage to any rubber lining and internal lateral systems. Feet should be placed on the lateral clamping bars, not on the laterals themselves and every effort taken to avoid standing on the small plastic strainers. Entry into the vessels should be discouraged but, if unavoidable, must be carried out under the supervision of the water treatment plant chemist or engineer.

On demineralising and mixed bed units, internal studs, nuts, bolts, and washers are made of high grade stainless steel, and it is essential that only the right quality replacements are used. The stainless steel is virtually non-magnetic and therefore the quality of a replacement can easily be confirmed with a magnet. Any items showing magnetic properties must be rejected.

Whenever a bolt or nut abuts against rubber, use the special rectangular plate washer. When tightening down on these washers ensure that friction between the nut (or bolt head) and the washer does not cause the washer to rotate and bite into the rubber lining.

Valves should be inspected regularly and gland packing wherever used should be replaced regularly. Valves of the plug type and some of diaphragm type which require lubrication should be attended to regularly.

### **2.1.1 Cation, anion and mixed bed units**

Inspect all units externally every six months including connecting pipework and valves. Chip away any loose paintwork and scale and make good with fresh paint. When the unit has been removed from service for internal inspection, close the manual inlet and outlet isolating valves as a safety measure and then open the AIR RELEASE and DRAIN valves.

Remove the manhole cover and examine the internal lining in the unit. If the lining is damaged and shows signs of bulging or lifting, or is suspect, carry out a spark test and rectify. Check procedures involved with your maintenance department. If the condition of the lining below the level of the resin is suspected, the resin will have to be removed.

Carry out an extended backwash with the manhole cover open and observe the bed performance. The water should break through evenly. If it breaks through from one side of the vessel and floods over the bed surface, or the bed breaks into lumps (indicating packing and channelling) backwash at the fastest possible flow rate without bringing

resin over, and stir with a stout rod until the bed is level and is of consistent density. Remove any 'fines' etc. by skimming the top surface and then shovelling them out.

After backwashing, drain the unit down and then note and record the bed level to some convenient point. Compare this measurement with the last recorded level as a check for resin loss. Note that in order to obtain an accurate bed measurement, the level must always be taken immediately following a backwashing operation. If the condition or performance of the resin is in suspect, take samples (approximately 150 mm and again 450 mm) and "arrange to get the sample analysed".

Refill the cation or anion unit by backwashing and double check bed depth, then refit the manhole cover.

On mixed bed units, carry out an air mix operation and observe the surface of the bed. The entire top water and resin should be in a fairly vigorous 'bubbling' stage.

When the mixed bed unit has been remixed, replace the manhole cover and open the AIR RELEASE valve. Fill the unit with water. Open the inlet valve and when water free of air flows from the AIR RELEASE pipe, close the AIR RELEASE valve.

## **2.1.2 Acid and caustic tanks**

### **2.1.2.1 Acid measuring tanks**

Every six months inspect all measuring tanks externally, including connecting pipework and valves. Remove any loose paintwork and scale and make good with fresh paint. If the internal condition of the tank is affected, the tank cover must be removed under the supervision of the water treatment plant chemist or engineer and the interior inspected, cleaned and repaired.

### **2.1.2.2 Caustic measuring tank**

Every six months inspect the measuring tank externally, including connecting pipework and valves. Remove any loose paintwork and scale and make good with fresh paint.

When the tank is empty, examine the inside and clean out any sludge from the bottom of the tank.

### 2.1.2.3 Bulk acid and caustic soda storage tanks

Every six months inspect both tanks externally including connecting pipework and valves. Remove any loose paintwork and scale, and make good with fresh paint.

If the internal condition of the tank is suspected, provision will have to be made for draining the tank, and any residual liquor and sludge diluted and neutralised.

## 2.2 Bed Depth

An ion exchange plant is designed to give a specified treated water quality when run on a particular raw water, the analysis of which has been used for the design. An economical quantity of resin required is decided upon and also an economical quantity of regenerant to achieve the required quality of treated water and capacity between regenerations.

The resin volume is a very important factor. If this is less, then a reduced capacity is obtained. A procedure is given below for measuring the ion exchange resin bed depth from which, by knowing the cross-section area of the pressure vessel, the resin volume can be computed.

### 2.2.1 Equipment

A scale long enough to measure the distance from the bottom of the unit to the top flange of the manhole. A length of 25 mm x 25 mm wood may be used. Alternatively, a length of PVC, GI or MS pipe.

#### **Note:**

For rubber lined units, GI or MS pipes should not be used as they might cause damage to the lining or to the collecting systems.

If a pipe or length of wood is used, a separate scale is required to measure the distance.

#### **Method:**

Open the top manhole.

Open WASH OUTLET, and then slowly open WASH INLET valves. This will fluidise the resin bed.

After 3-5 minutes carefully insert the measuring pipe into the unit, through the resin, until it reaches the bottom.

**Note:**

Where a SILEX under bed is employed, the pipe is to be inserted down to this level.

Where no SILEX is used, the collecting system may be one of several types - header and lateral, or strainer on plate. In both cases polypropylene strainers are employed. Hence, care should be taken to see that no damage occurs to these or other components. This pipe should be carefully manoeuvred so that it reaches the bottom plate.

Hold the pipe vertical. Mark off the distance to a convenient reference point such as the manhole flange.

Remove the pipe and repeat procedure to check the depths at two other points, then remove pipe.

Measure the distance marked-off on the pipe (A).

Continue backwashing for 10 minutes then close WASH INLET valve. This results in the resin settling down under gravity.

After 5 minutes of settlement, slowly open the RINSE OUTLET valve and let the unit drain slowly at a flow rate not exceeding  $4.5 \text{ m}^3/\text{h}/\text{m}^2$  of bed area.

When the water drains down to the resin bed level, close the RINSE OUTLET valve.

Re-insert the measuring pipe through the manhole down to the bed surface and mark off the depth up to the same reference point. Repeat this at two other points.

Remove the pipe and measure this distance (B).

Open the WASH INLET valve slowly and allow the unit to fill up. When water comes out from the wash outlet pipe, close the WASH INLET and WASH OUTLET valves. Close the manhole.

Knowing the cross-section area of the pressure vessel and the depth of resin (A-B), calculate the resin volume and check that it is as per the TECHNICAL DATA SHEET.

**Note:**

The bed depth of both the strong acid cation and strong base anion resins are measured in the exhausted form of these resins.

## 2.3 Air scour and extended backwash

Due to prolonged use under varying pressure and flow conditions, the ion exchange resin tends to break up. Normal annual loss, known as attrition loss, is about 5%. The particles thus formed are known as 'fines'. These fines if allowed to remain in the resin bed tend to choke the bed, thus increasing the pressure drop across the bed and reducing the flow through it. Some of these particles thus formed are normally eliminated during backwash but those which go down deep into the resin bed are not removed. Hence it is advisable to remove these fines. IT IS RECOMMENDED THAT THIS BE DONE ONCE IN THREE MONTHS.

### 2.3.1 Equipment

An air hose of sufficient length to reach the bottom of the resin bed. The hose should be weighed at the end to facilitate its reaching the bottom of the resin bed.

Air supply at 0.5 kg/cm<sup>2</sup> g.

A bucket to remove the fines.

### 2.3.2 Method

Open the BACKWASH OUTLET valve.

Open the manhole.

Close the BACKWASH OUTLET valve and open the RINSE OUTLET valve.

Drain the water till level is about 300 mm above the resin bed.

Insert the air hose halfway into the resin bed taking care to see it does not reach the bottom of the bed and disturb the under bed if any.

Connect the hose to air supply and start the air.

Move the hose throughout the resin.

Continue this operation for 15 minutes.

Cut off air supply and remove the air hose.

Open BACKWASH OUTLET valve and slowly open BACKWASH INLET valve taking care that the effluent water does not carry good resin beads.

After the backwashing is over, close the BACKWASH INLET valve and the BACKWASH OUTLET valve by.

Open RINSE OUTLET valve and drain the water to slightly below the resin bed level.

Scrape off 6 mm (1/2") layer from the top of the resin bed and discard this (see note).

Close the manhole cover.

The unit is now ready for further use.



**Note:**

In case a ladder is to be used for reaching the resin bed, care should be taken that there is no damage to the rubber lining, if the vessel is rubber lined.

## 2.4 Resin Sampling

### 2.4.1 For softeners, cation, anion exchange units

**Equipment:**

One pipe (25 mm diameter) of sufficient length (with stopper or cork at one end) to dip at least 500 mm into the resin bed.

Polyethylene bag to hold approximately 300 ml of resin.

**Procedure:**

Do a normal backwash of the unit.

Allow the resin bed to settle under gravity for 3-5 minutes.

Open the manhole.

Open RINSE OUTLET valve and allow the water to drain slowly down to the resin bed (5-10 minutes.)

Insert the pipe piece corked at one end into the resin bed. The pipe piece should go into the bed to a depth of about 300 mm.

Release the cork for a minute or so. Then re-cork the pipe.

Quickly withdraw the pipe and hold the polyethylene bag at the open end i.e. the end which was dipped inside the resin bed.

Release the cork and tap the pipe.

If no resin falls into the bag, blow into the pipe from the other end.

See that the resin sample so collected is about 300 ml.

Drain water from the bag if any and seal the bag so that the resin is kept in a moist condition.

Close the manhole and use the unit as per requirement.

## 2.4.2 For mixed bed units

### **Equipment:**

Polyethylene bag to hold 300 ml of sample.

A 500 ml beaker.

String or tongs to lower the beaker into the unit.

### **Procedure:**

Open the manhole and do the air mix as stated under operation.

After 5 minutes of mixing and while air mixing is going on, lower the beaker and withdraw it after it is full of resin.

Transfer about 300 ml of resin into the polyethylene bag and seal the bag. Use the unit as required.

After samples have been taken, the units should be filled up with an upflow of water. This should be done very slowly especially in units where plastic distribution systems are employed. Ensure that the water rises up through the resin bed evenly; the dry resin bed should not rise up in a mass.

### **Despatching samples:**

Pack the samples securely and despatch it to the supplier labelled with the following particulars. Please note that the RESIN SAMPLE SHOULD ALWAYS BE SENT IN A MOIST CONDITION.

Contract Number.

Sender's name and address to which analysis report is to be sent.

Type of resin.

Unit from which the resin was taken.

State of resin i.e. exhausted or regenerated.

## 2.5 Resin Removal and Replacement

The performance of the ion exchange resins used in the treatment units will gradually deteriorate and therefore needs to be replaced at varying intervals depending upon service conditions and the type of resin being used. When it is necessary to remove the resin either for replacement or to gain access to the vessel for repair purpose, the following procedure should be adopted.

**Necessary equipment:**

Mild steel rubber lined spool piece approximately 100 mm long and with flanges suitable to match the resin outlet pad dimensions.

Cast iron rubber lined diaphragm valve suitable for connecting the spool piece above.

Mild steel rubber lined bend with suitable flanges at one end for connecting the above valve.

Sufficient hessian sacks to contain the resin must be clean and should not be torn.

**Resin removal:**

Isolate the unit and open the air release valve.

Remove the unit manhole cover and open the rinse outlet valve.

Drain the water completely.

Open the blind from resin outlet pad and fit the spool piece, valve and bend, in that order. Use rubber gaskets at joints and required fasteners.

Close rinse outlet valve and open the unit inlet valve partially to admit water into the unit.

Throttle the valve connected to the resin outlet pad to control the resin flow and collect the resin in the hessian bags.

When all the resin up to the resin outlet pad has been removed, close the unit inlet valve and open the unit backwash inlet valve to fluidise the bed and to remove resin below the level of the resin pad.

Close all the valves.

**Resin replacement:**

Opportunity may be taken at this stage to thoroughly inspect the vessel; internal fittings and repairs may be carried out.

Fill 3/4 of the unit with water by opening the wash inlet valve.

Pour the correct quantity and type of resin.

Check the resin bed.

Replace the manhole cover.

Total quantity of water passed through the resin since use, and number of regenerations carried out.

**Note:**

Contract number and type of resin can be checked from the operation manual.

Some treatment units such as the ones operating on counter flow regeneration have a collecting system near the resin surface. Extreme care should be taken when inserting the pipe so that no damage is done to this.

Care is required to see that no damage is done to any rubber covered and plastic items.

## 2.6 Treatment of Organic Fouling

**Introduction:**

Some raw water supplies contain appreciable quantities of organic matter of vegetable origin. Most of this organic matter is removed during the demineralising process and is removed from the ion exchange resin during regeneration, but some remains in the anion exchange resin. If unchecked this reduces the efficiency of the anion exchange resin.

Organic fouling shows itself in one or more of the following ways:

Prolonged rinse time. The rinse may have to be continued for more than the stipulated time to obtain the required quality of demineralised water.

Unsatisfactory demineralised water quality.

Conductivity of demineralised water may not fall below the stipulated figure.

Residual silica in demineralised water may increase slowly.

Reduced capacity. The quantity of good demineralised water obtained per regeneration may fall steadily.

These effects will occur slowly. A sudden drop in quality or capacity can usually be ascribed to some other cause e.g. a change in raw water characteristics, or incorrect operation of the plant. Before assuming that organic fouling is taking place, the raw water analysis should be checked and the plant regenerated carefully. A resin sample should be sent for analysis.

IT IS RECOMMENDED THAT TREATMENT OF ORGANIC FOULING SHOULD BE DONE, AS A ROUTINE, ONCE IN THREE MONTHS.

**Equipment:**

Tank to hold alkaline brine solution (see note).

Stirring arrangement in the tank.

Pump or ejector with relevant pipework and valves for alkaline brine injection.

**Chemical requirement:**

Two resin bed volumes of alkaline brine solution containing 10% w/v NaCl and 1% w/v NaOH.

**Chemical preparation:**

Prepare the required volume of alkaline brine at the appropriate concentrations depending on the system of injection that will be used for the purpose. For example, if the solution is to be pumped directly into the unit prepare two resin bed volumes of 10 % NaCl and 1 % NaOH for injection. If an ejector (1:1 ratio) or a pump and a mixing tee arrangement is used, prepare a lower volume but of higher concentration to account for dilution water. In all cases ensure that you inject two resin bed volumes at a concentration of 10 % NaCl and 1 % NaOH.

**Method:**

Open INLET valve and AIR RELEASE valve to fill up water in the vessel. When water flows out through air release pipe, close air release and inlet valves.

Next inject alkaline brine solution at the same flow rate as is done in normal alkali injection.

After all the alkaline brine solution is injected into the unit close the valves.

Let the resin soak in the alkaline brine solution for eight hours or overnight.

After the soak, open INLET valve and AIR RELEASE valve.

When water comes out of the air release pipe, close AIR RELEASE valve.

Open FINAL RINSE valve and adjust the rate to the final rinse flow rate. Continue rinsing for 45 minutes or till effluent is clear, whichever is later.

Regenerate the unit with double the quantity of caustic than normally used for regeneration.

**Note:**

The total volume of alkaline brine should be about twice the volume of resin i.e. if the resin is 100 litres then the volume of alkaline brine solution will be 200 litres but care should be taken that concentration of NaCl in the solution should be 10% and of caustic soda 1%.

In case the ejector etc. are not incorporated with the unit then a pump is necessary to inject brine into the vessel. In this case the brine is injected into the vessel from the manhole.

If the tank already provided for regeneration is not sufficient to hold the entire quantity of alkaline brine, then the injection of brine could be done in two stages. If such is the case, the brine is injected once, the resin is soaked and then the brine injection is done again.

The salt used should be of vacuum dried quality to avoid precipitation of calcium and magnesium hydroxides on the resin bed.

## ANNEXURE - 6

### TROUBLESHOOTING OF ULTRA FILTRATION AND REVERSE OSMOSIS UNITS

#### 1.0 Ultra Filtration Unit

Problem	Checkpoints	Solutions
Total increase in bacterial count	Check the total count every day and make a trend analysis over a period of time	Sanitise either with chemicals or hot water with proper retention
	Analyse the sample	This will help to analyse the cause
	Check the components, gaskets, tricolour clamps	Change gaskets Check alignment of pipework
	Check the surface finish of the components used	Passivation or electropolishing of the piping joints
	Check the conditions of weld joints	Reweld/rework/replace in case of any problem
	Check whether the ultra filtration system is idle for more time or is in continuous operation	Run the system continuously
	Avoid exposing to light	At least cover the membranes with dark paper
	Check the gaskets in valves and aging	Replace if required
Reduction in flow rate	Check the flow rate and calculate % reduction	Check for any blocks
	Check organic matter/COD/BOD/TOC/TSS/Turbidity	Modify the pretreatment
	Check the total count	Chemical cleaning/hot water sanitising
	Check for any foreign particles	Remove particles
	Check for leakage on joints	Attend to the leakage
	Bio-film formation due to idle condition	Use chemicals to clean the UF system
	Fibre breakage	Check and plug the fibres
	Check the valves	Ensure proper opening/dosing operation of valves
	Check the air pressure in case of automatic unit	Low pressure can cause problems in the opening/closing of valves
	Check the flow metre	Calibrate the metre

Problem	Checkpoints	Solutions
Slimy layer/ colour change of UF membrane	Avoid exposure to sunlight or light source	Wrap/cover ultra filtration membranes with dark paper
	Remove the bio-film	Sanitise with either chemicals or hot water with proper retention
	Low velocity	Operate at high velocity or at full flows as per design Chemical dosing
	Check the components, gaskets, triclover clams	Arrest leakage if any
Treated water colour	Check for high TOC/organics	Modify the pretreatment
	Check the high turbidity	Modify the pretreatment
	Check for iron and other heavy metals	Modify the pretreatment
	Rust formation on the pipelines	Remove the rust with ultra filtration treated water and check the material
High pressure drop	Check the flow rate	Adjust flow as per design Chemical cleaning of UF
	Check the colour of membrane	Chemical cleaning, hot water sanitising
	Check the actual flow rate v/s design	Adjust flow rates
	Feed and reject pressure reading mismatch	Calibrate pressure gauges for proper reading
	Check organic matter	Modify the pretreatment
	Check for high TVC	Modify the pretreatment
	Check the flow	Calibrate the metre
Leakage of joints	Check the nature of leakage	Check alignment of joints
	Check the components, gaskets, triclover clamps	Replace if required
	Check the surface finish of the components used	Rework/ electropolish/replace the components
	Check for rust formation or any other spots or scaling or corrosion on pipework or fittings	Check the material of construction
	Check the condition of weld joints	Check the material of construction
	Check pH of feed water	Low pH can cause corrosion
	Check for chlorine	Chlorine can cause corrosion Drain the chemically sanitised water
	Check the welding	Poor welding needs rectification,
	Check the workmanship	Rectify and improve
High TOC value at outlet	Check the inlet	Modify the pretreatment
	Check the fibres	Plug the broken fibres
High endotoxin value at outlet	Check the total viable count at inlet	Modify the pretreatment
	Check the storage tank	Avoid stagnation of water
	Check for algae in storage tank	Chlorinate water in storage tank



## 2.0 Reverse Osmosis Troubleshooting Matrix

Possible Cause	Possible Location	Pressure Drop	Feed Pressure	Salt Passage
<b>Metal Oxide Fouling</b> (e.g. Fe, Mn, Cu, Ni, Zn)	1 <sup>st</sup> stage lead elements	Rapid increase	Rapid increase	Rapid increase
<b>Colloidal Fouling</b> (organic and/or inorganic complexes)	1 <sup>st</sup> stage lead elements	Gradual increase	Gradual increase	Slight increase
<b>Mineral Scaling</b> (e.g. Ca, Mg, Ba, Sr)	Last stage tail elements	Moderate increase	Slight increase	Marked increase
<b>Polymerised Silica</b>	Last stage tail elements	Normal to increased	Increased	Normal to increased
<b>Biological Fouling</b>	Any stage, usually lead elements	Marked increase	Marked increase	Normal to increased
<b>Organic Fouling</b> (dissolved NOM)	All stages	Gradual increase	Increased	Decreased
<b>Antiscalant Fouling</b>	2 <sup>nd</sup> stage most severe	Normal to increased	Increased	Normal to increased
<b>Oxidant damage</b> (e.g. Cl <sub>2</sub> , ozone, KMnO <sub>4</sub> )	1 <sup>st</sup> stage most severe	Normal to decreased	Decreased	Increased
<b>Hydrolysis damage</b> (out of range pH)	All stages	Normal to decreased	Decreased	Increased
<b>Abrasion damage</b> (carbon fines, etc)	1 <sup>st</sup> stage most severe	Normal to decreased	Decreased	Increased
<b>O-ring leaks</b> (at interconnectors or adapters)	Random (typically at feed adapter)	Normal to decreased	Normal to decreased	Increased
<b>Glue line leaks</b> (due to permeate back-pressure in service or standby)	1 <sup>st</sup> stage most severe	Normal to decreased	Normal to decreased	Increased
<b>Glue line leaks</b> (due to closed permeate valve while cleaning or flushing)	Tail element of a stage	Increased (based on prior fouling & high delta P)	Increased (based on prior fouling & and high delta P)	Increased

## 2.1 Discussion on Foulants

### 2.1.1 Calcium carbonate scale

Calcium carbonate is a mineral scale and may be deposited from almost any feed water if there is a failure in the antiscalant/dispersant addition system or in the acid injection pH control system that results in a high feed water pH. An early detection of the resulting calcium carbonate scaling is absolutely essential to prevent the damage that crystals can cause on the active membrane layers. Calcium carbonate scale that has been detected early can be removed by lowering the feed water pH to between 3.0 and 5.0 for one or two hours. Longer resident accumulations of calcium carbonate scale can be removed by a low pH cleaning with a citric acid solution.

### 2.1.2 Calcium, barium & strontium sulphate scale

Sulphate scale is a much “harder” carbonate and is more difficult to remove. Sulphate scale may be deposited if there is a failure in the antiscalant / dispersant feed system or if there is an over feed of sulphuric acid in pH adjustment. Early detection of the resulting sulphate scaling is absolutely essential to prevent the damage that crystals can cause on the active membrane layers. Barium and strontium sulphate scales are particularly difficult to remove as they are insoluble in almost all cleaning solutions, so special care should be taken to prevent their formation.

### 2.1.3 Calcium phosphate scale

This scale is particularly common in municipal waste waters and polluted water supplies which may contain high levels of phosphate. This scale can generally be removed with acidic pH cleaners.

### 2.1.4 Metal oxide/hydroxide foulants

Typical metal oxide and metal hydroxide foulants are iron, zinc, manganese, copper, aluminum, etc. They can be the result of corrosion products from unlined pipes and tanks, or result from the oxidation of the soluble metal ion with air, chlorine, ozone, potassium permanganate, or they can be the result of a pretreatment filter system upset that utilises iron or aluminum-based coagulant aids.

### 2.1.5 Polymerised Silica Coating

A silica gel coating resulting from the super-saturation and polymerisation of soluble silica can be very difficult to remove. It should be noted that this type of silica fouling is different from silica-based colloidal foulants, which may be associated with either metal hydroxides or organic matter. Silica scale can be very difficult to remove by traditional chemical cleaning methods. If traditional methods are unsuccessful, there do

exist harsher cleaning chemicals, like ammonium bifluoride, that have been used successfully at some sites but they are considered rather hazardous to handle and can damage equipment.

### **2.1.6 Colloidal foulants**

Colloids are inorganic or mixed inorganic/organic based particles that are suspended in water and will not settle by gravity. Colloidal matter typically contains one or more of the following major components: iron, aluminum, silica, sulphur or organic matter.

### **2.1.7 Dissolved natural organic matter (NOM) organic foulants**

The sources of dissolved NOM foulants are typically derived from the decomposition of vegetative material into surface waters or shallow wells. The chemistry of organic foulants is very complex, with the major organic components being either humic acid or fulvic acid. Dissolved NOMs can quickly foul RO membranes by being absorbed onto the membrane surface. Once absorption has occurred, then a slower fouling process of gel or cake formation starts. It should be noted that the mechanism of fouling with dissolved NOM should not be confused with the mechanism of fouling created by NOM organic material that is bound up with colloidal particles.

### **2.1.8 Microbiological deposits**

Organic-based deposits resulting from bacterial slimes, fungi, moulds, etc. can be difficult to remove, particularly if the feed path is plugged. Plugging of the feed path makes it difficult to introduce and distribute the cleaning solutions. To inhibit additional growth, it is important to clean and sanitise not only the RO system, but also the pretreatment, piping, dead-legs, etc. The membranes, once chemically cleaned, will require the use of an approved biocide and an extended exposure to be effective.

## **2.2 Selection and Use of Cleaning Chemicals**

There are a number of factors involved in the selection of a suitable cleaning chemical (or chemicals) and proper cleaning protocol. The first time you have to perform a cleaning, it is recommended to contact the manufacturer of the equipment, the RO element manufacturer, or an RO specialty chemical and service supplier. Once the suspected foulant(s) is identified, one or more cleaning chemicals will be recommended. These cleaning chemical(s) can be generic or can be private-labelled proprietary chemicals. Typically, the generic chemicals can be of technical grades and are available from local chemical supply companies. Proprietary RO cleaning chemicals can be more expensive, but may be easier to use and you cannot rule out the advantage of the intellectual knowledge supplied

by these companies. Some independent RO service companies can determine the proper chemicals and cleaning protocol for your situation by testing, at their facility, a fouled element pulled from your system.

It is not unusual to use a number of different cleaning chemicals in a specific sequence to achieve optimum cleaning. Typically, a high pH cleaning is used first to remove foulants like oil or biological matter, followed by a low pH cleaning to remove foulants like mineral scale or metal oxides/hydroxides fouling. There are times that the orders of high and low pH cleaning solutions is reversed or one solution only is required to clean the membranes. Some cleaning solutions have detergents added to aid in the removal of heavy biological and organic debris, while others have a chelating agent like EDTA added to aid in the removal of colloidal material, organic and biological material, and sulphate scale. It is important to remember that the improper selection of a cleaning chemical, or sequence of chemical introduction, can make the situation worse.

Membrane system operator should thoroughly investigate the signs of fouling before selecting a cleaning chemical and cleaning protocol. Some forms of fouling (iron deposits and scaling commonly associated with well waters) may require only a simple low pH cleaning. However, for most complex fouling phenomena, the following sequence are recommended.

1. Flushing with permeate with addition of non-oxidising biocide (DBNPA or similar type) at the end of the flushing.
2. High pH cleaning in place (CIP)
3. Flushing with permeate until pH on the brine side is below pH 8.5
4. Low pH CIP
5. Acid flushing with permeate and non-oxidising biocide (DBNPA or similar type)

## **2.3 General Precautions in Selection and Usage of Cleaning Chemicals**

- If you are using a proprietary chemical, make sure the chemical has been qualified for use with your membrane by the chemical supplier
- If you are using generic chemicals, make sure the chemical has been qualified for use with your membrane
- Use the least harsh cleaning regimen to get the job done. This includes the cleaning parameters of pH, temperature, and contact time. This will optimise the useful life of the membrane

- Clean at the recommended target temperatures to optimise cleaning efficiency and membrane life
- Use the minimal amount of chemical contact time to optimise membrane life
- Be prudent in the adjustment of pH at the low and high pH range to extend the useful life of the membrane. A “gentle” pH range is 4 to 10, while the harshest pH range is 2 to 12
- Oil and biologically-fouled membranes should not use a low pH clean-up first as the oil and biological matter will congeal
- Cleaning and flushing flows should usually be in the same direction as the normal feed flow to avoid potential telescoping and element damage. In certain cases, where heavy feed end fouling has occurred, reverse flow cleaning may be more effective in removing the foulant
- When cleaning a multi-stage RO, the most effective cleaning is one stage at a time so that cleaning flow velocities can be optimised and foulants removed from upstream stages
- Flushing out detergents with higher pH permeate can reduce foaming problems
- Verify that proper disposal requirements for the cleaning solution are followed
- If your system has been fouled biologically, you may want to consider the extra step of introducing a sanitising biocide chemical before and after a successful cleaning. Biocides can be introduced before and immediately after cleaning, periodically (e.g. once a week), or continuously during service. You must be sure that the biocide is compatible with the membrane, does not create any health risks, is effective in controlling biological activity, and is not cost-prohibitive
- For safety reasons, always add chemicals slowly to an agitated batch of make-up water
- For safety reasons, always wear safety glasses and protective gear when working with chemicals
- For safety reasons, don't mix acids with caustics. Thoroughly rinse the first cleaning solution from the RO system before introducing the next solution

## 2.4 Selecting a Cleaning Solution

The recommended generic chemical solutions for cleaning an RO membrane element is based on the foulant to be removed.

### Recommended chemical cleaning solutions

Foulant	Gentle Cleaning Solution	Harsher Cleaning Solution
Calcium carbonate scale	1	4
Calcium, barium or strontium Sulphate scale	2	4
Metal oxides/hydroxides (Fe, Mn, Zn, Cu, Al)	1	5
Inorganic colloidal foulants	1	4
Mixed inorganic/organic colloidal foulants	2	6
Polymerised silica coating	None	7
Biological matter	2 or 3	6
NOM organic matter (naturally occurring)	2 or 3	6

## 2.5 Description of cleaning solutions

### Note:

The notation (w) denotes that the diluted chemical solution strength is based on the actual weight of the 100% pure chemical or active ingredient.

### Solution 1:

This is a low pH cleaning solution of 2.0% (w) citric acid ( $C_6H_8O_7$ ). It is useful in removing inorganic scale (e.g. calcium carbonate, calcium sulphate, barium sulphate, strontium sulphate) and metal oxides/hydroxides (e.g. iron, manganese, nickel, copper, zinc), and inorganic-based colloidal material.

### Note:

Citric acid is available as a powder.

### Solution 2:

This is a high pH cleaning solution (target pH of 10.0) of 2.0% (w) of STPP (sodium tripolyphosphate) ( $Na_5P_3O_{10}$ ) and 0.8% (w) of Na-EDTA (sodium salt of ethylamine diamine tetra acetic acid). It is specifically recommended for removing calcium sulphate scale and light to moderate levels of organic foulants of natural origin. STPP functions as an inorganic-

based chelating agent and detergent. Na-EDTA is an organic-based chelating cleaning agent that aids in the sequestering and removal of divalent and trivalent cations and metal ions. STPP and Na-EDTA are available as powders.

**Solution 3:**

This is a high pH cleaning solution (target pH of 10.0) of 2.0% (w) of STPP (sodium tripolyphosphate) ( $\text{Na}_5\text{P}_3\text{O}_{10}$ ) and 0.025% (w) Na-DDBS ( $\text{C}_{12}\text{H}_{25}(\text{CH}_2)_{11}\text{SO}_3\text{Na}$ ) (sodium salt of dodecyl benzene sulfonate). It is specifically recommended for removing heavier levels of organic foulants of natural origin. STPP functions as an inorganic-based chelating agent and detergent. Na-DDBS functions as an anionic detergent.

**Solution 4:**

This is a low pH cleaning solution (target pH of 2.5) of 0.5% (w) of HCl (hydrochloric) acid. It is useful in removing inorganic scale (e.g. calcium carbonate, calcium sulphate, barium sulphate, strontium sulphate and metal oxides/hydroxides (e.g. iron, manganese, nickel, copper, zinc) and inorganic-based colloidal material. This cleaning solution is considered to be harsher than Solution 1. HCl acid, a strong mineral acid, is also known as muriatic acid. HCl acid is available in a number of concentrations: (180 Baume = 27.9%), (200 Baume = 31.4%), (220 Baume = 36.0%).

**Solution 5:**

This is a lower pH cleaning solution (natural pH is between pH 4 and 6. No pH adjustment is required) 1.0% (w) of  $\text{Na}_2\text{S}_2\text{O}_4$  (sodium hydrosulfite). It is useful in the removal of metal oxides and hydroxides (especially iron fouling), and, to a lesser extent, calcium sulphate, barium sulphate and strontium sulphate. Sodium hydrosulfite is a strong reducing agent and is also known as sodium dithionite. The solution will have a very strong odour so proper ventilation is required. Sodium hydrosulfite is available as a powder.

**Solution 6:**

This is a high pH cleaning solution (target pH of 11.5) of 0.1% (w) of NaOH (sodium hydroxide) and 0.03% (w) of SDS (sodium dodecyl Sulphate). It is useful in the removal of organic foulants of natural origin, colloidal foulants of mixed organic/inorganic origin, and biological material (fungi, mold, slimes and biofilm). SDS is a detergent that is an anionic surfactant that will cause some foaming. This is considered to be a harsh cleaning regimen.

**Solution 7:**

This is a high pH cleaning solution (target pH of 11.5) of 0.1% (w) of NaOH (sodium hydroxide). It is useful in the removal of polymerised silica. This is considered to be a harsh cleaning regimen.

## ANNEXURE - 7

### TABLE FOR CONVERTING TO CALCIUM CARBONATE

	Symbol	Ionic Weight	Equivalent Weight	To convert to CaCO <sub>3</sub> multiply by
<b>Cation</b>				
Aluminium	Al <sup>+++</sup>	27	9	5.56
Ammonium	NH <sub>4</sub> <sup>++</sup>	18	18	2.78
Barium	Ba <sup>++</sup>	137.4	68.7	0.728
Calcium	Ca <sup>++</sup>	40.1	20.05	2.49
Copper	Cu <sup>++</sup>	63.6	31.8	1.57
Hydrogen	H <sup>+</sup>	1.0	1.0	50.0
Iron (Ferrous)	Fe <sup>++</sup>	55.85	27.8	1.80
Iron (Ferric)	Fe <sup>+++</sup>	55.85	18.6	2.69
Magnesium	Mg <sup>+++</sup>	24.3	12.2	4.10
Manganese	Mn <sup>++</sup>	54.9	27.5	1.82
Potassium	K <sup>+</sup>	39.1	39.1	1.28
Sodium	Na <sup>+</sup>	23.0	23.0	2.17
<b>Anion</b>				
Bicarbonate	HCO <sub>3</sub> <sup>-</sup>	61	61	0.82
Bisulphate	HSO <sub>4</sub> <sup>-</sup>	97.1	97.1	0.515
Bisulphite	HSO <sub>3</sub> <sup>-</sup>	81.1	81.1	0.617
Carbonate	CO <sub>3</sub> <sup>--</sup>	60	30	1.67
Chloride	Cl <sup>-</sup>	35.5	35.5	1.41
Fluoride	F <sup>-</sup>	19	19	2.63
Hydroxide	OH <sup>-</sup>	17	17	2.94
Nitrate	NO <sub>3</sub> <sup>-</sup>	62	62	0.807
Phosphate (Monovalant)	H <sub>2</sub> PO <sub>4</sub> <sup>-</sup>	97	97	0.516
Phosphate (Divalent)	HOP <sub>4</sub> <sup>--</sup>	96	48	1.04
Phosphate (Trivalent)	PO <sub>4</sub> <sup>---</sup>	95	31.7	1.58
Sulphate	SO <sub>4</sub> <sup>--</sup>	96.1	48	1.04
Sulphide	S <sup>--</sup>	32.1	16	3.12
Sulphite	SO <sub>3</sub> <sup>--</sup>	80.1	40	1.25
Alum (Filter)	Al <sub>2</sub> (SO <sub>4</sub> ) <sub>3</sub> ·18H <sub>2</sub> O	666.1	111	0.45
Alum (Ammonium)	Al <sub>2</sub> (SO <sub>4</sub> ) <sub>3</sub> (NH <sub>4</sub> ) <sub>2</sub> SO <sub>4</sub> ·24 H <sub>2</sub> O	906.2	151	0.331



	Symbol	Ionic Weight	Equivalent Weight	To convert to CaCO <sub>3</sub> multiply by
Alum (Potassium)	Al <sub>2</sub> (SO <sub>4</sub> ) <sub>3</sub> ·K <sub>2</sub> SO <sub>4</sub> ·24H <sub>2</sub> O	948.4	158	0.316
Aluminium Hydroxide	Al(OH) <sub>3</sub>	78	26	1.92
Aluminium Oxide	Al <sub>2</sub> O <sub>3</sub>	101.9	17	2.94
Aluminium Sulphate (Anhydrous)	Al <sub>2</sub> (SO <sub>4</sub> ) <sub>3</sub>	342.1	57	0.978
Ammonia	NH <sub>3</sub>	17	17	2.94
Ammonium Hydroxide	NH <sub>4</sub> OH	35	35	1.43
Barium Carbonate	BaCO <sub>3</sub>	197.3	98.7	0.507
Barium Chloride	BaCl <sub>2</sub>	208.3	104.1	0.48
Barium Hydroxide	Ba(OH) <sub>2</sub> ·8H <sub>2</sub> O	315.3	157.7	0.317
Barium Sulphate	BaSO <sub>4</sub>	233.4	116.7	0.429
Calcium Bicarbonate	Ca(HCO <sub>3</sub> ) <sub>2</sub>	162.1	81.1	0.617
Calcium Carbonate	CaCO <sub>3</sub>	100.1	50	1
Calcium Chloride	CaCl <sub>2</sub>	111.0	55.5	0.902
Calcium Hydroxide (Hydrated Lime)	Ca(OH) <sub>2</sub>	74.1	37.1	1.35
Calcium Nitrate	Ca(NO <sub>3</sub> ) <sub>2</sub>	162.0	81	0.61
Calcium Oxide (Quicklime)	CaO	56.1	28	1.79
Calcium Phosphate	Ca <sub>3</sub> (PO <sub>4</sub> ) <sub>2</sub>	310.2	51.7	0.967
Calcium Sulphate (Anhydrous)	CaSO <sub>4</sub>	136.1	68.1	0.735
Calcium Sulphate (Gypsum)	CaSO <sub>4</sub> ·2H <sub>2</sub> O	172.1	86.1	0.581
Carbon Dioxide	CO <sub>2</sub>	44	44	1.14
Chlorine (Gas)	Cl <sub>2</sub>	70.9	35.5	1.41
Copper Sulphate (Blue Vitriol)	CuSO <sub>4</sub> ·5H <sub>2</sub> O	249.6	124.8	0.401
Disodium Phosphate	Na <sub>2</sub> HPO <sub>4</sub> ·12H <sub>2</sub> O	358.2	119.4	0.418
Disodium Phosphate (Anhydrous)	Na <sub>2</sub> HPO <sub>4</sub>	142.0	47.3	1.06
Ferric Chloride (Anhydrous)	FeCl <sub>3</sub>	162.2	54.1	0.925
Ferric Chloride (Hydrate)	FeCl <sub>3</sub> ·6H <sub>2</sub> O	270.2	90.1	0.555

	Symbol	Ionic Weight	Equivalent Weight	To convert to CaCO <sub>3</sub> multiply by
Ferric Hydroxide	Fe(OH) <sub>3</sub>	106.9	35.6	1.40
Ferric Sulphate	Fe <sub>2</sub> (SO <sub>4</sub> ) <sub>3</sub>	399.8	66.6	0.751
Ferrous Sulphate (Anhydrous)	FeSO <sub>4</sub>	151.9	76.0	0.658
Ferrous Sulphate (Copperas)	FeSO <sub>4</sub> ·7H <sub>2</sub> O	277.9	139	0.36
Hydrazine	N <sub>2</sub> H <sub>4</sub>	32	32	1.56
Hydrochloric Acid	HCl	36.5	36.5	1.37
Hydrofluoric Acid	HF	20	20	2.50
Magnesium Bicarbonate	Mg(HCO <sub>3</sub> ) <sub>2</sub>	146.3	73.2	0.683
Magnesium Carbonate	MgCO <sub>3</sub>	84.3	42.2	1.19
Magnesium Chloride	MgCl <sub>2</sub>	95.2	47.6	1.05
Magnesium Hydroxide	Mg(OH) <sub>2</sub>	58.3	29.2	1.71
Magnesium Nitrate	Mg(NO <sub>3</sub> ) <sub>2</sub>	148.0	74	0.675
Magnesium Oxide	MgO	40.3	20.2	2.48
Magnesium Phosphate	Mg <sub>3</sub> (PO <sub>4</sub> ) <sub>2</sub>	262.9	43.8	1.14
Magnesium Sulphate (Anhydrous)	MgSO <sub>4</sub>	120.4	60.2	0.83
Magnesium Sulphate (Epsom Salts)	MgSO <sub>4</sub> ·7H <sub>2</sub> O	246.4	123.2	0.405
Manganese Oxide	MnO <sub>2</sub>	86.9	21.7	2.30
Monosodium Phosphate (Anhydrous)	NaH <sub>2</sub> PO <sub>4</sub>	120	40	1.25
Monosodium Phosphate	NaH <sub>2</sub> PO <sub>4</sub> ·H <sub>2</sub> O	138	47	1.09
Morpholine	C <sub>4</sub> H <sub>9</sub> NO	87	87	0.575
Nitric Acid	HNO <sub>3</sub>	63	63	0.794
Phosphoric Acid	H <sub>3</sub> PO <sub>4</sub>	98	32.7	1.53
Potassium Carbonate	K <sub>2</sub> CO <sub>3</sub>	138.2	69.1	0.724
Potassium Chloride	KCl	74.6	74.6	0.67
Potassium Hydroxide	KOH	56.1	56.1	0.891

	Symbol	Ionic Weight	Equivalent Weight	To convert to CaCO <sub>3</sub> multiply by
Potassium Iodide	KI	166	166	0.301
Potassium Nitrate	KNO <sub>3</sub>	101.1	101.1	0.495
Potassium Permanganate	KMNO <sub>4</sub>	157	159	0.317
Silver Chloride	AgCl	143.3	143.3	0.349
Silver Nitrite	AgNO <sub>3</sub>	169.9	169.9	0.294
Silica	SiO <sub>2</sub>	60.1	60.1	0.835
Sodium Bicarbonate	NaHCO <sub>3</sub>	84.0	84	0.595
Sodium Bisulphite	NaHSO <sub>3</sub>	104.1	104.1	0.96
Sodium Carbonate (Soda Ash)	Na <sub>2</sub> CO <sub>3</sub>	106	53	0.943
Sodium Chloride	NaCl	58.5	58.5	0.8555
Sodium Fluoride	NaF	42	42	1.19
Sodium Hydroxide	NaOH	40	40	1.25
Sodium Metaphosphate	NaPO <sub>3</sub>	102	102	0.49
Sodium Nitrate	NaNO <sub>3</sub>	85	85	0.588
Sodium Sulphate	Na <sub>2</sub> SO <sub>4</sub>	142.1	71	0.704
Sodium Sulphite	Na <sub>2</sub> SO <sub>3</sub>	126.1	63	0.794
Sulphur Dioxide	SO <sub>2</sub>	64.1	32	1.56
Sulphuric Acid	H <sub>2</sub> SO <sub>4</sub>	98.1	49	1.02
Sulphurous Acid	H <sub>2</sub> SO <sub>3</sub>	82.1	41	1.22
Trisodium Phosphate	Na <sub>3</sub> PO <sub>4</sub> · 12 H <sub>2</sub> O	380.0	126.7	0.395
Trisodium Phosphate (Anhydrous)	Na <sub>3</sub> PO <sub>4</sub>	164.0	54.7	0.914

## ANNEXURE - 8

### CONVERSION OF COMMON UNITS

From	To	Multiply by
To	From	Divide by
inch (in)	metre (m)	0.0254
foot (ft)	metre (m)	0.3048
yard (yd)	metre (m)	0.9144
<b>AREA</b>		
in <sup>2</sup>	m <sup>2</sup>	0.0006452
ft <sup>2</sup>	m <sup>2</sup>	0.0929
yd <sup>2</sup>	m <sup>2</sup>	0.8361
<b>VOLUME</b>		
in <sup>3</sup>	litre (l)	0.01639
ft <sup>3</sup>	litre (l)	28.32
yd <sup>3</sup>	litre (l)	764.6
Imp. Gallon (U.K.)	litre (l)	4.546
U.S. Gallon (gal.)	litre (l)	3.785
<b>MASS</b>		
grain (gr)	gram (g)	0.0648
Ounce	gram (g)	28.35
pound (lb)	gram (g)	453.6
<b>PRESSURE</b>		
Atmosphere (atm)	kPa	101.3
Bar	kPa	100.0
lb/ft <sup>2</sup>	kPa	0.04788
lb/in <sup>2</sup> = psi	bar	0.069
lb/in <sup>2</sup> = psi	kPa	6.895

## ANNEXURE - 9

### CONDUCTIVITY OF SOLUTIONS AT VARIOUS TEMPERATURES

	0° C 32° F	18° C 64° F	25° C 77° F	50° C 122° F
HCl	0.66	0.89	1.00	1.37
H <sub>2</sub> SO <sub>4</sub>	0.66	0.87	1.00	1.38
NaCl	0.53	0.86	1.00	1.57
NaOH	0.54	0.89	1.00	1.51
KOH	0.55	0.89	1.00	1.50

## ANNEXURE - 10

### RECOMMENDED MAXIMUM IMPURITY LEVELS FOR HCl, NaOH AND NaCl

#### Hydrochloric Acid (HCl)

Fe	0.01%
Other metals, total	10 mg/l
Organic matter	0.01%
Sulphuric acid, as SO <sub>3</sub>	0.4%
Oxidants (HNO <sub>3</sub> , Cl <sub>2</sub> )	5 mg/l
Suspended matter as turbidity	~ 0
Inhibitors	None

#### Sodium Hydroxide (NaOH)

NaCl	0.6%
NaClO <sub>3</sub>	30 mg/l
Na <sub>2</sub> CO <sub>3</sub>	0.75%
Fe	10 mg/l
Heavy metals (total)	5 mg/l
SiO <sub>2</sub>	50 mg/l
Na <sub>2</sub> SO <sub>4</sub>	0.2%

#### Sodium Chloride (NaCl)

SO <sub>4</sub> <sup>- -</sup>	1%
Mg <sup>++</sup> Ca <sup>++</sup>	0.5%

## ANNEXURE - 11

### TYPICAL ANALYSIS FOR DIFFERENT CAUSTIC QUALITIES

Compound	Mercury1 Grade	Rayon1 Grade	Regular Diaphragm Grade	Regular Technical Flake
NaOH	51%	50.1%	50.4%	98%
Na <sub>2</sub> CO <sub>3</sub>	0.02%	0.2%	0.2%	0.5-1%
NaClO <sub>3</sub>	1 mg/l	2 mg/l	0.5%l	2 mg/l
NaCl	0.002%	0.2-.05%	1-2%	0.4-1.5%
NaSO <sub>4</sub>	10 mg/l	0.1%l	0.03%	0.3%
Fe	1 mg/l	10 mg/l	15 mg/l	10 mg/l
Heavy metals (total)	2 mg/l	4 mg/l	N.S.	2 mg/l
SiO <sub>2</sub>	10 mg/l	40 mg/l	N.S.	500 mg/l

## ANNEXURE - 12

### CONVERSION OF CONDUCTIVITY TO RESISTANCE

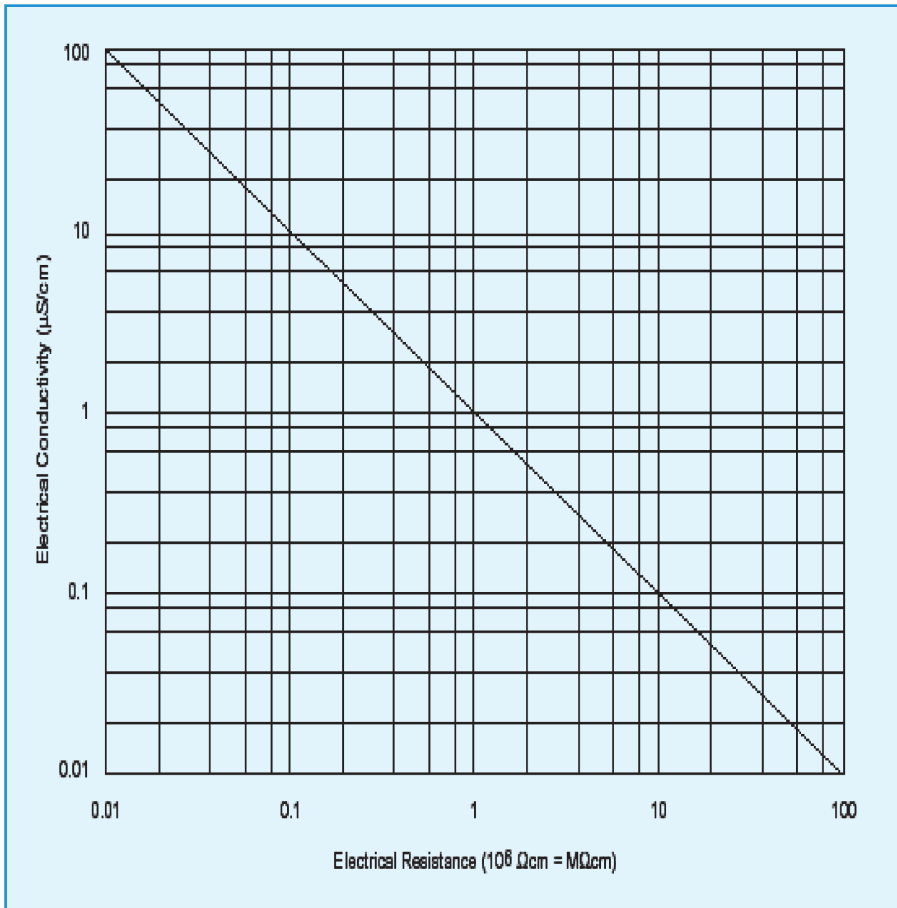



## ANNEXURE - 13

### CONDUCTIVITY OF WATER AS FUNCTION OF TEMPERATURE

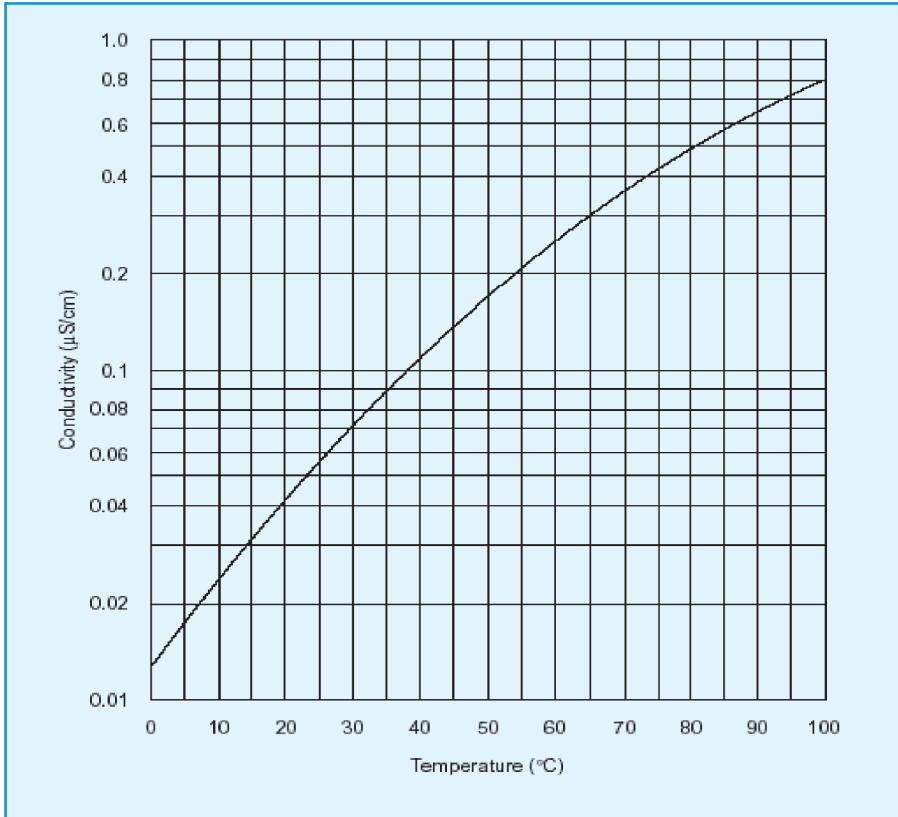

## ANNEXURE - 14

### CONDUCTANCE VS TOTAL DISSOLVED SOLIDS

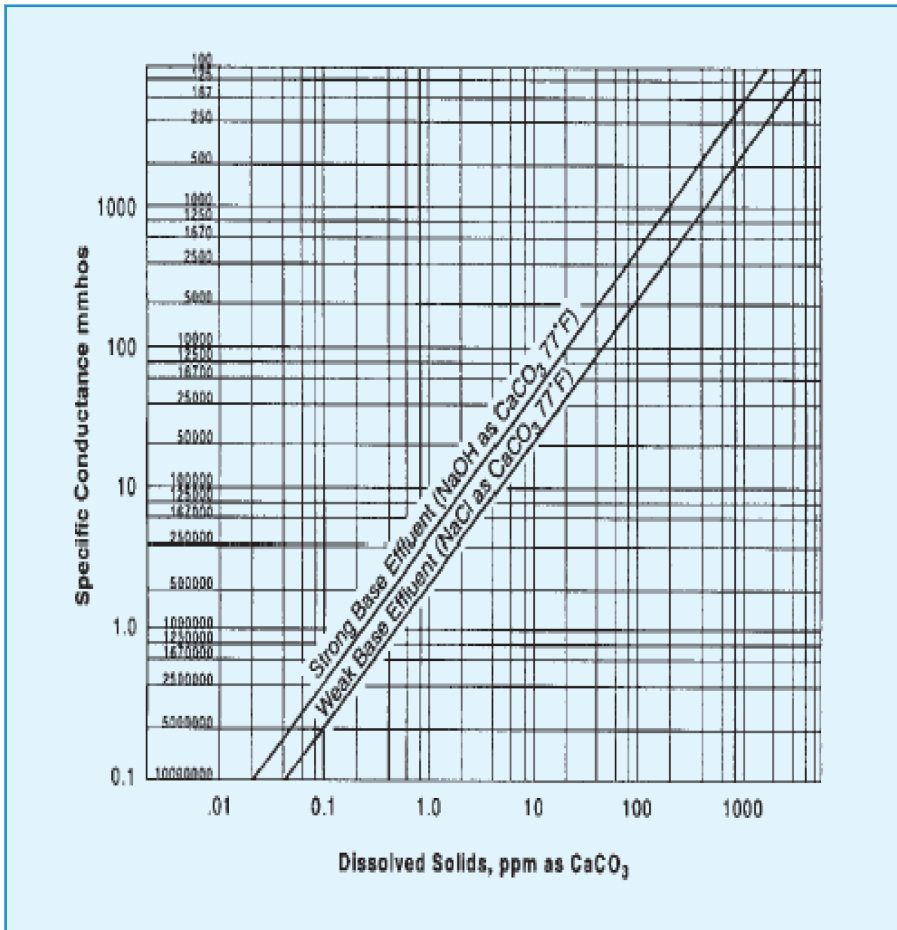

## ANNEXURE - 15

### RELATIONSHIP BETWEEN DISSOLVED SOLIDS AND CONDUCTANCE IN DEMINERALISATION OPERATIONS

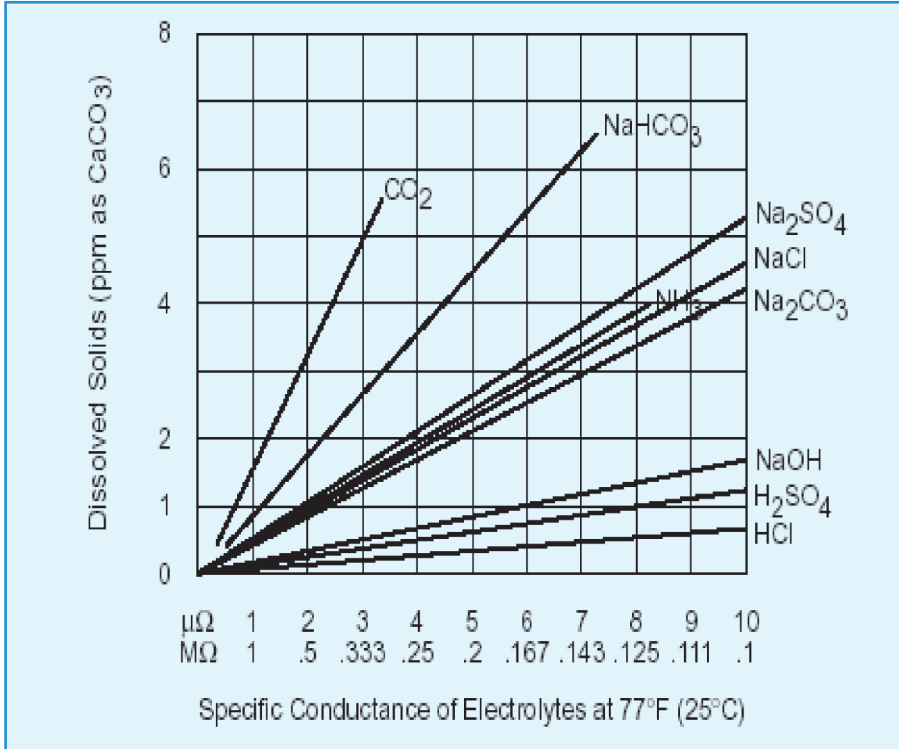

## ANNEXURE - 16

### pH OF PURE WATER AS FUNCTION OF TEMPERATURE

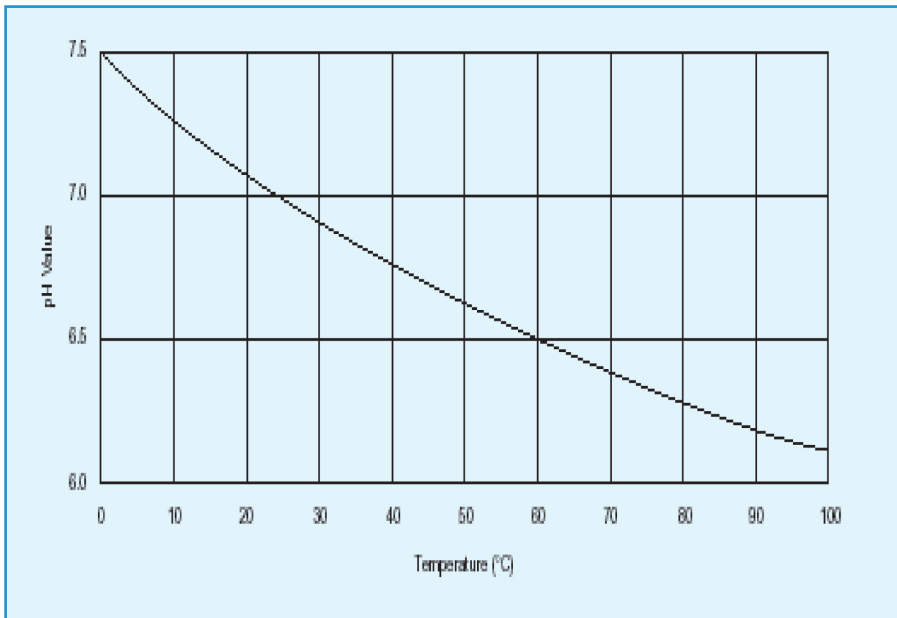

## ANNEXURE - 17

### pH OF BASIC SOLUTIONS AT 25° C (77° F)

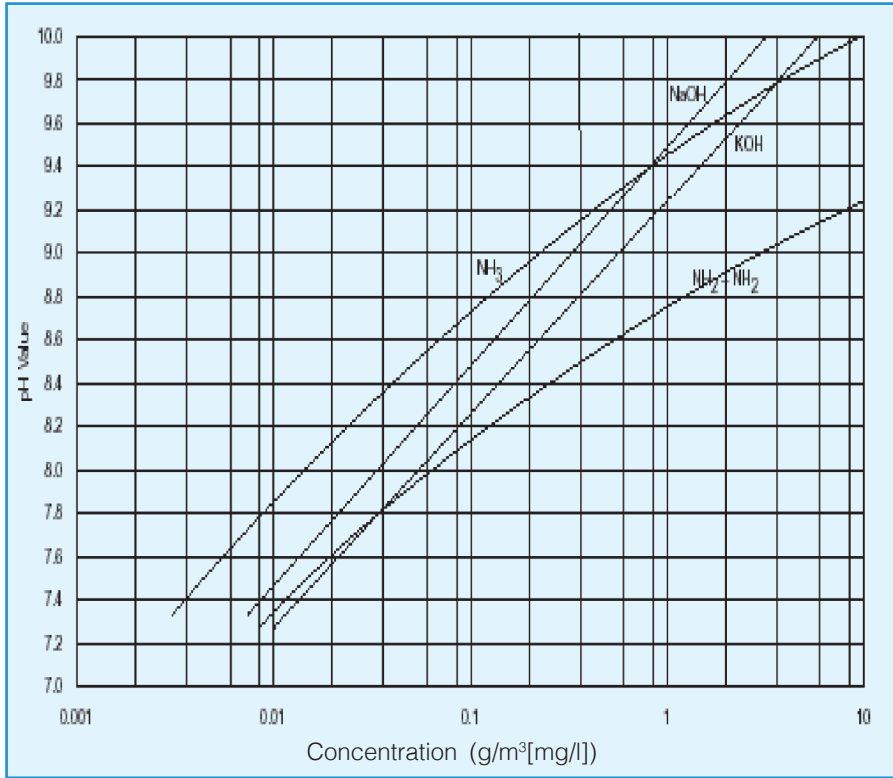

## ANNEXURE - 18

### pH OF ACID SOLUTIONS AT 25° C (77° F)

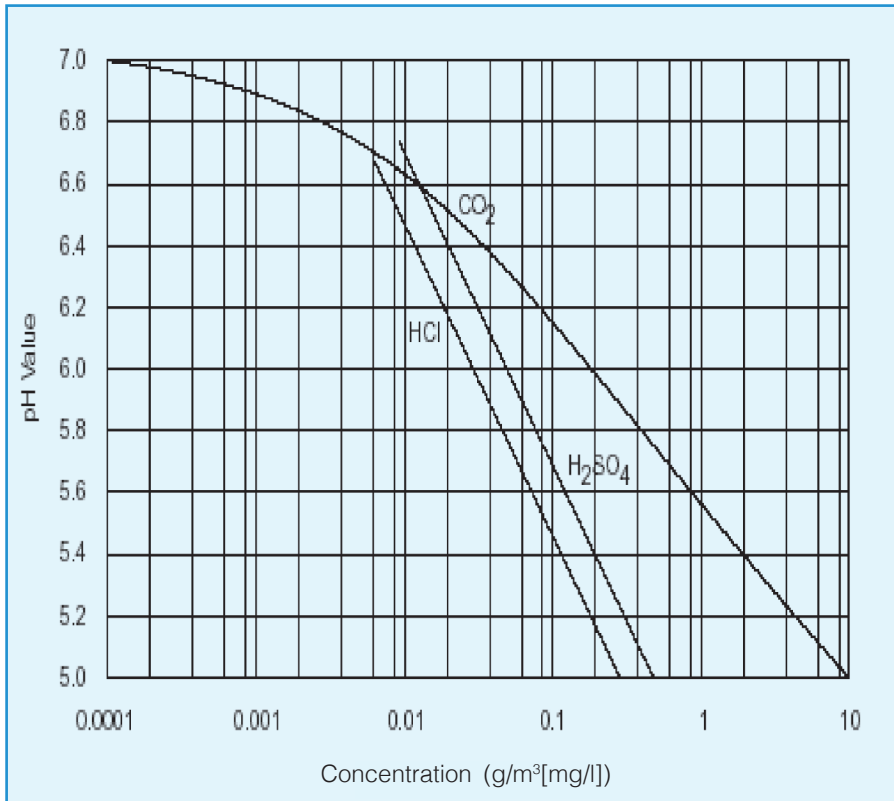

## ANNEXURE - 19

### SPECIFICATIONS OF FILTER MEDIA

Sr. No.	Parameters	Unit	Value	Remarks
1	<b>Anthracite</b>			
	Density	kg/m <sup>3</sup>	800	For use in dual media filters
	Bed Depth	M	0.610 – 0.194	
	Service Flow	m <sup>3</sup> /h/m <sup>2</sup>	12.22	
	Backwash Flow	m <sup>3</sup> /h/m <sup>2</sup>	29.32 – 43.97	
2	<b>Activate Alumina</b>			
	Density	kg/m <sup>3</sup>	688	For removal of fluoride, arsenic and humic acid
	Bed Depth	M	0.914+	
	Service Flow	m <sup>3</sup> /h/m <sup>2</sup>	2.44 – 4.88	
	Backwash Flow	m <sup>3</sup> /h/m <sup>2</sup>	19.54 – 24.43	
3	<b>Crushed Marble (Calcite)</b>			
	Density	kg/m <sup>3</sup>	1600	For correction of pH of RO treated water
	Bed Depth	M	0.610 – 0.762	
	Service Flow	m <sup>3</sup> /h/m <sup>2</sup>	4.88 – 14.66	
	Backwash Flow	m <sup>3</sup> /h/m <sup>2</sup>	24.43 – 29.32	
4	<b>Granular Activated Carbon</b>			
	Density	kg/m <sup>3</sup>	400	For removal of free chlorine, odour and taste
	Bed Depth	M	0.610 – 0.914	
	Chlorine Removal Service Flow	m <sup>3</sup> /h/m <sup>2</sup>	7.33 – 12.22	
	Organic Removal Service Flow	m <sup>3</sup> /h/m <sup>2</sup>	2.44 – 7.33	
	Backwash Flow	m <sup>3</sup> /h/m <sup>2</sup>	19.54 – 24.43	
5	<b>Kdf 85</b>			
	Density	kg/m <sup>3</sup>	1200	For removal of Iron, manganese and H <sub>2</sub> S
	Bed Depth	M	0.254+	
	Service Flow	m <sup>3</sup> /h/m <sup>2</sup>	36.65	
	Backwash Flow	m <sup>3</sup> /h/m <sup>2</sup>	73.29	
6	<b>Manganese Greensand</b>			
	Density	kg/m <sup>3</sup>	1361	For removal of iron, manganese and H <sub>2</sub> S
	Bed Depth	M	0.762 – 0.914	
	Service Flow	m <sup>3</sup> /h/m <sup>2</sup>	4.88 – 12.22	
	Backwash Flow	m <sup>3</sup> /h/m <sup>2</sup>	29.32 – 36.65	

Sr. No.	Parameters	Unit	Value	Remarks
7	<b>Multi-Media (Anthracite, Sand And Garnet)</b>			
	Density	kg/m <sup>3</sup>	1463	For use as depth filter and reduce SDI
	Bed Depth	M	0.914	
	Service Flow	m <sup>3</sup> /h/m <sup>2</sup>	24.43	
Backwash Flow	m <sup>3</sup> /h/m <sup>2</sup>	36.65		
8	<b>Sand</b>			
	Density	kg/m <sup>3</sup>	1600	For removal of suspended solids
	Bed Depth	M	0.457 – 0.914	
	Service Flow	m <sup>3</sup> /h/m <sup>2</sup>	7.33 – 12.22	
Backwash Flow	m <sup>3</sup> /h/m <sup>2</sup>	36.65 – 48.86		



## ANNEXURE - 20

### INDIAN STANDARD SPECIFICATIONS FOR DRINKING WATER (IS: 10500)

S.No	Parameter	Unit	Requirement desirable Limit	Remarks
1.	Colour	Hazen	5	May be extended up to 50 if toxic substances are suspected
2.	Turbidity	NTU	10	May be relaxed up to 25 NTU in the absence of alternate
3.	pH	-	6.5 to 8.5	May be relaxed up to 9.2 in the absence
4.	Total Hardness	mg/l	300	May be extended up to 600 mg/l
5.	Calcium as Ca	mg/l	75	May be extended up to 200 mg/l
6.	Magnesium as Mg	mg/l	30	May be extended up to 100 mg/l
7.	Copper as Cu	mg/l	0.05	May be relaxed up to 1.5 mg/l
8.	Iron	mg/l	0.3	May be extended up to 1 mg/l
9.	Manganese	mg/l	0.1	May be extended up to 0.5 mg/l
10.	Chlorides	mg/l	250	May be extended up to 1000 mg/l
11.	Sulphates	mg/l	150	May be extended up to 400 mg/l
12.	Nitrates	mg/l	45	No relaxation
13.	Fluoride	mg/l	0.6 to 1.2	If the limit is below 0.6 water should be rejected, max. limit is extended to 1.5
14.	Phenols	mg/l	0.001	May be relaxed up to 0.002 mg/l
15.	Mercury	mg/l	0.001	No relaxation
16.	Cadmium	mg/l	0.01	No relaxation
17.	Selenium	mg/l	0.01	No relaxation
18.	Arsenic	mg/l	0.05	No relaxation
19.	Cyanide	mg/l	0.05	No relaxation
20.	Lead	mg/l	0.1	No relaxation
21.	Zinc	mg/l	5.0	May be extended up to 10.0 mg/l
22.	Anionic Detergents (MBAS)	mg/l	0.2	May be relaxed up to 1
23.	Chromium as Cr <sup>6+</sup>	mg/l	0.05	No relaxation
24.	Poly Nuclear Aromatic Hydrocarbons	mg/l	--	--
25.	Mineral Oil	mg/l	0.01	May be relaxed up to 0.03
26.	Residual free Chlorine	mg/l	0.2	Applicable only when water is chlorinated

## ANNEXURE - 21

### WORLD HEALTH ORGANIZATION STANDARDS FOR DRINKING WATER (1993)

Element/ substance	Symbol/ formula	Normally found in fresh water/surface water/ ground water	Health based guideline by the WHO
Aluminium	Al		0.2 mg/l
Ammonia	NH <sub>4</sub>	< 0.2 mg/l (up to 0.3 mg/l in anaerobic waters)	No guideline
Antimony	Sb	< 4 µg/l	0.005 mg/l
Arsenic	As		0.01 mg/l
Asbestos			No guideline
Barium	Ba		0.3 mg/l
Berillium	Be	< 1 µg/l	No guideline
Boron	B	< 1 mg/l	0.3 mg/l
Cadmium	Cd	< 1 µg/l	0.003 mg/l
Chloride	Cl		250 mg/l
Chromium	Cr <sup>+3</sup> , Cr <sup>+6</sup>	< 2 µg/l	0.05 mg/l
Colour			Not mentioned
Copper	Cu		2 mg/l
Cyanide	CN <sup>-</sup>		0.07 mg/l
Dissolved oxygen	O <sub>2</sub>		No guideline
Fluoride	F	< 1.5 mg/l (up to 10)	1.5 mg/l
Hardness	mg/l CaCO <sub>3</sub>		No guideline
Hydrogen sulphide	H <sub>2</sub> S		No guideline
Iron	Fe	0.5 - 50 mg/l	No guideline
Lead	Pb		0.01 mg/l
Manganese	Mn		0.5 mg/l
Mercury	Hg	< 0.5 µg/l	0.001 mg/l
Molybdenum	Mb	< 0.01 mg/l	0.07 mg/l
Nickel	Ni	< 0.02 mg/l	0.02 mg/l
Nitrate and nitrite	NO <sub>3</sub> <sup>-</sup> , NO <sub>2</sub> <sup>-</sup>		50 mg/l total nitrogen
Turbidity			Not mentioned
pH			No guideline
Selenium	Se	< < 0.01 mg/l	0.01 mg/l
Silver	Ag	5 – 50 µg/l	No guideline
Sodium	Na	< 20 mg/l	200 mg/l
Sulphate	SO <sub>4</sub>		500 mg/l
Inorganic tin	Sn		No guideline
TDS			No guideline
Uranium	U		1.4 mg/l
Zinc	Zn		3 mg/l

## ANNEXURE - 22

### 1.0 Typical Feed Condensate Analysis for Sub-Critical Power Plant

Sr. No	Parameters	Unit	Value Start up	Value Normal	Value Leakage
1	Ammonia (NH <sub>3</sub> )	ppb	1,500	500	500
2	Sodium	ppb	---	10	---
3	Iron	ppb	---	50	---
4	Copper	ppb	--	5	---
5	Silica	ppb	150	30	---
6	Chlorides	ppb	--	10	---
7	pH	---	9.5	8.0 - 8.5	---
8	Total Dissolved Solids	ppb	2,000	100	2,000
9	Conductivity @ 25° C	µS/cm	--	1.0 -2.0	---
10	Crud	ppb	500 (av)	25	---

### 2.0 Typical Effluent Condensate Analysis for Sub-Critical Power Plant

Sr. No	Parameters	Unit	Value Start up	Value Normal	Value Leakage
1	Cycle of operation		H-Cycle	H-Cycle	H-Cycle
2	Cycle time	days	2	15	2
3	Ammonia (NH <sub>3</sub> )	ppb	---	---	---
4	Sodium	ppb	---	2	20
5	Iron	ppb	50	5	---
6	Copper	ppb	--	1	---
7	Silica	ppb	20	5	15
8	Chlorides	ppb	--	2	---
9	pH	---	6.8 – 7.2	6.8 – 7.2	---
10	Total Dissolved Solids	ppb	---	20	---
11	Conductivity @ 25° C	µS/cm	0.2	0.1	---
12	Crud	ppb	150	5	---

### 3.0 Typical Feed Condensate Analysis for Super Critical Power Plant

Sr. No	Parameters	Unit	Value Start up	Value Normal	Value Leakage
1	Ammonia (NH <sub>3</sub> )	ppb	1500	100	100
2	Sodium	ppb	---	10	---
3	Iron	ppb	---	50	---
4	Copper	ppb	--	5	---
5	Silica	ppb	150	30	---
6	Chlorides	ppb	--	10	---
7	pH	---	9.5	8.0 - 8.5	---
8	Total Dissolved Solids	ppb	2000	100	2000
9	Conductivity @ 25° C	μS/cm	--	1.0 -2.0	---
10	Crud	ppb	500 (av)	25	---

### 4.0 Typical Effluent Condensate Analysis for Super Critical Power Plant

Sr. No	Parameters	Unit	Value Start up	Value Normal	Value Leakage
1	Cycle of operation	-	H-Cycle	H-Cycle	H-Cycle
2	Cycle time	days	2	30	2
3	Ammonia (NH <sub>3</sub> )	ppb	---	---	---
4	Sodium	ppb	---	2	20
5	Iron	ppb	50	5	---
6	Copper	ppb	--	1	---
7	Silica	ppb	20	5	15
8	Chlorides	ppb	--	2	---
9	pH	---	6.8 – 7.2	6.8 – 7.2	---
10	Total Dissolved Solids	ppb	---	20	---
11	Conductivity @ 25° C	μS/cm	0.2	0.1	---
12	Crud	ppb	150	5	---

## 5.0 Feed Condensate Analysis comparison for Super Critical Power Plant (660 MW) in Normal Operation

Sr. No	Parameters	Unit	BTPC Bulk Tender (11 X 660 Mw)	ALFA INFRAPROP (TCE)	L&T JP Nigree (DCPL)
1	Ammonia (NH <sub>3</sub> )	ppb	(11 X 660 Mw)	100	100
2	Sodium	ppb	10	10	10
3	Iron	ppb	50	50	50
4	Copper	ppb	---	10	10
5	Silica	ppb	30	30	30
6	Chlorides	ppb	10	10	20
7	pH @ 25° C	---	8.8 – 9.5	---	8.8 – 9.3
8	Total Dissolved Solids	ppb	100	---	100
9	Conductivity @ 25° C	μS/cm	---	---	0.3
10	Crud	ppb	25	50	50
11	H <sub>2</sub> CO <sub>3</sub>	ppb	---	50	---

## 6.0 Feed Condensate Analysis comparison for Super Critical Power Plant (800 MW) in Normal Operation

Sr. No	Parameters	Unit	CGPL Mundra (TCE) (5X800 MW)	L&T Krishna (2X800 Mw)
1	Ammonia (NH <sub>3</sub> )	ppb	100	100
2	Sodium	ppb	10	10
3	Iron	ppb	50	50
4	Copper	ppb	10	10
5	Silica	ppb	30	30
6	Chlorides	ppb	10	10
7	pH @ 25° C	---	---	---
8	Total Dissolved Solids	ppb	---	---
9	Conductivity @ 25° C	μS/cm	---	---
10	Crud	ppb	50	50

## 7.0 Effluent Condensate Analysis for Super Critical Power (800 MW) Plant for Various Project

Sr. No	Parameters	Unit	CGPL Mundra (TCE) (5X800 MW)	L&T Krishna (2X800 Mw)
1	Cycle of operation	-	H-Cycle	H-Cycle
2	Cycle time	days	30	30
3	Ammonia (NH <sub>3</sub> )	ppb	---	---
4	Sodium	ppb	2	2
5	Iron	ppb	5	5
6	Copper	ppb	3	3
7	Silica	ppb	5	5
8	Chlorides	ppb	2	2
9	pH	---	6.8 – 7.2	6.8 – 7.2
10	Total Dissolved Solids	ppb	25	25
11	Conductivity @ 25° C	µS/cm	0.10	0.10
12	Crud	ppb	5	5

## ANNEXURE - 23

### STEPWISE OPERATION OF THE CONDENSATE POLISHING PLANT

#### Step-0 Condensate Polishing Plant Service and Regeneration System under Standby

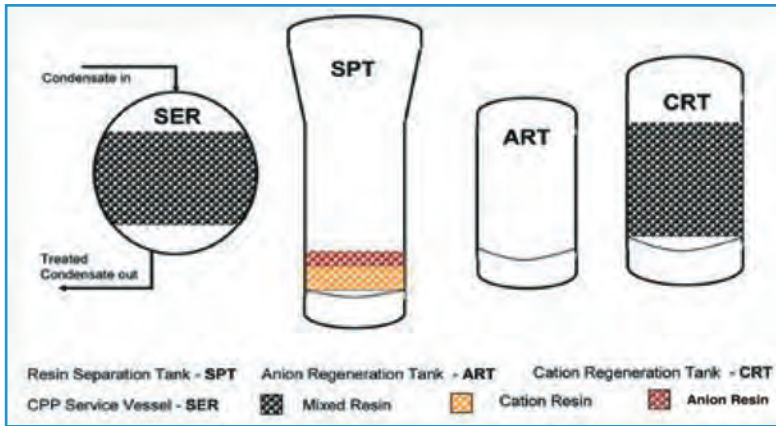

#### Step-1 Resin Transfer from Service Vessel to Separation Tank (SPT)

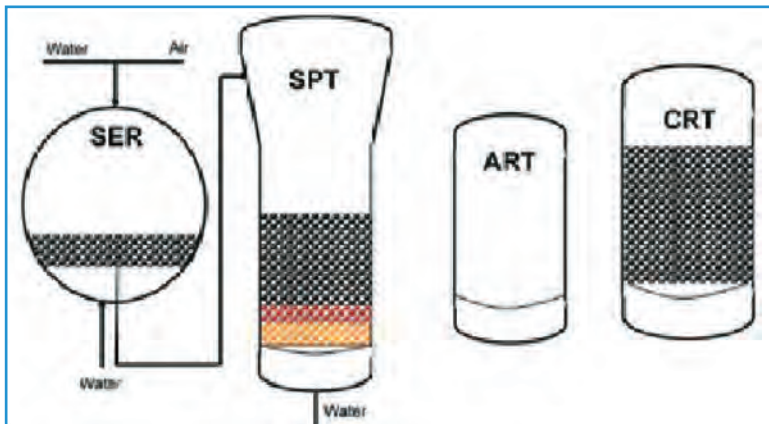

### Step-2 Resin Cleaning in Resin Separation Tank (SPT)

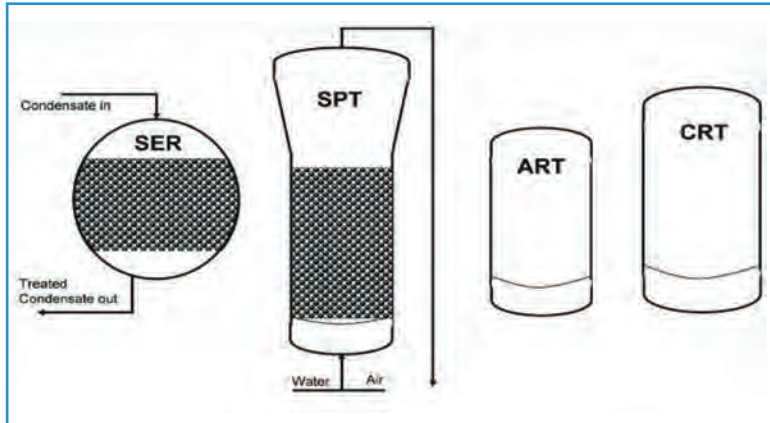

### Step-3 Resin Separation in Separation Tank (SPT) by Backwashing with Reducing Flow

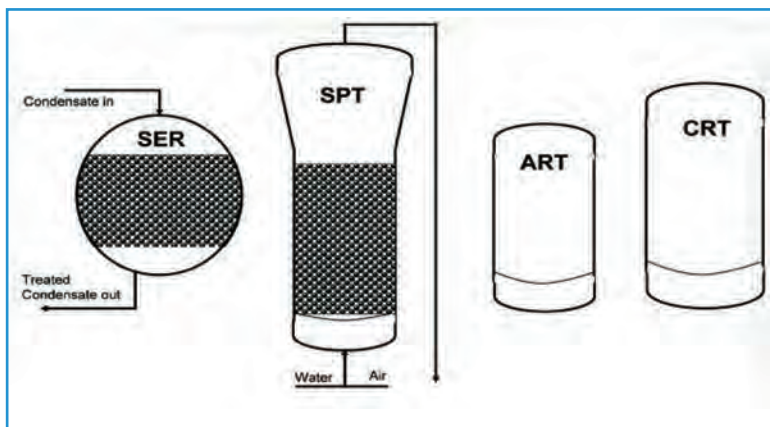



### Step-4 Anion Resin Transfer from Separation Tank (SPT) to Anion Regeneration tank (ART)

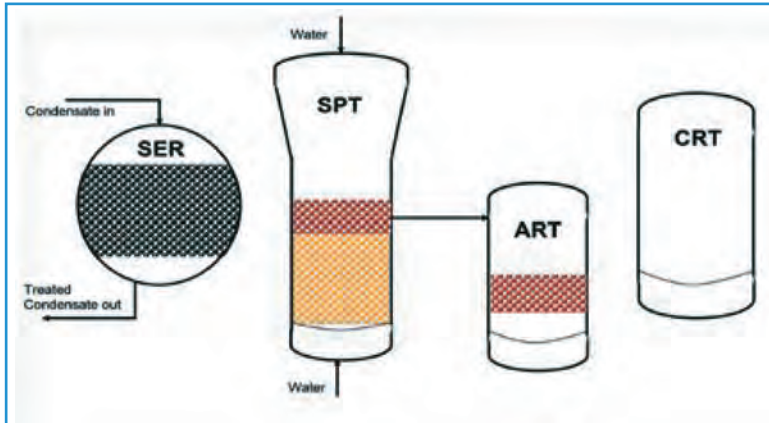

### Step-5 Cation Resin Transfer from Separation Tank (SPT) to Cation Regeneration Tank (CRT)

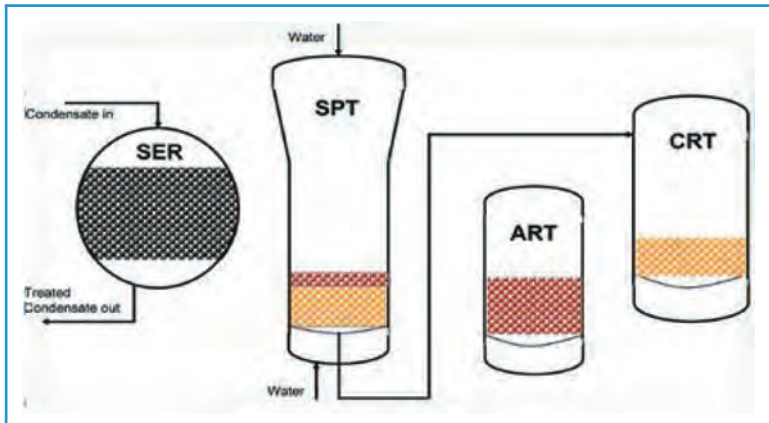

### Step-6 Regeneration of Anion and Cation Resins

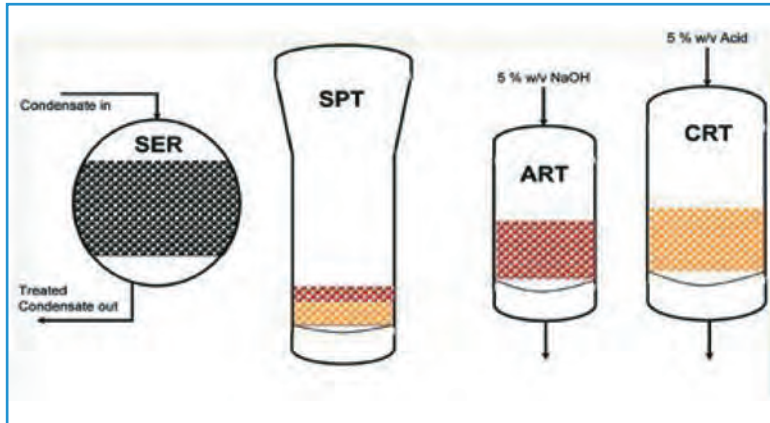

### Step-7 Chemical Displacement and Final Rinse of each Resin Bed

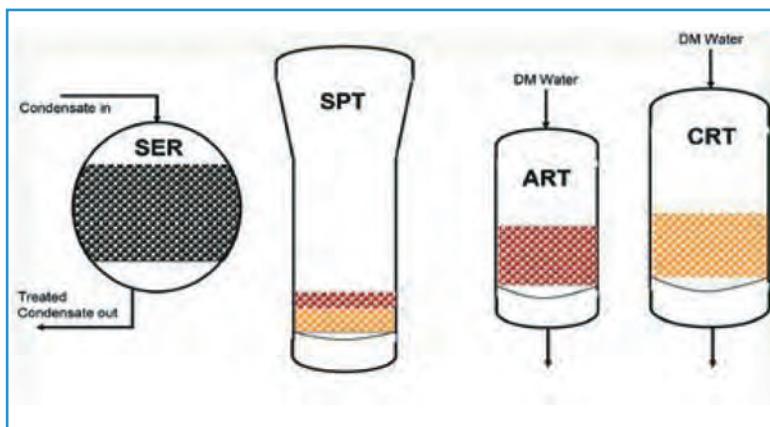

### Step-8 Anion Resin Transfer from Anion regeneration Tank (ART) to Cation Regeneration Tank (CRT)

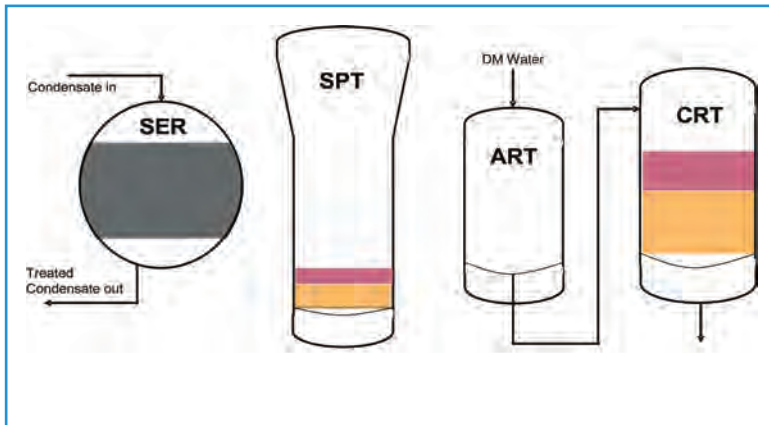

### Step-9 Resin Mixing in Cation Regeneration cum Mixed Resin Storage Tank (CRT)

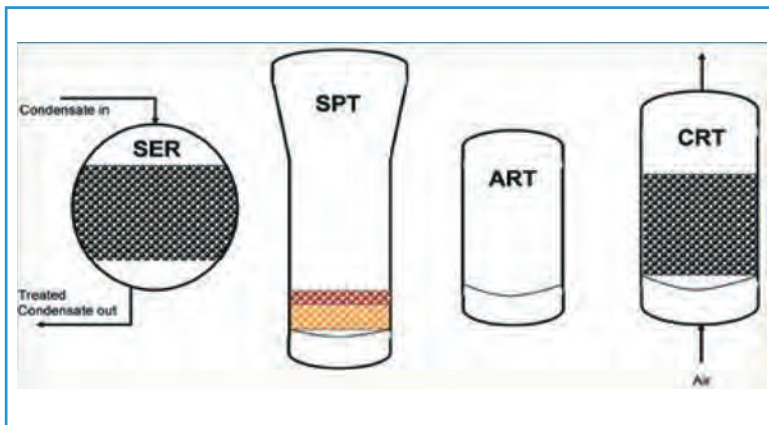

### Step-10 Mixed Resin Final Rinse in Cation Regeneration Tank (CRT)

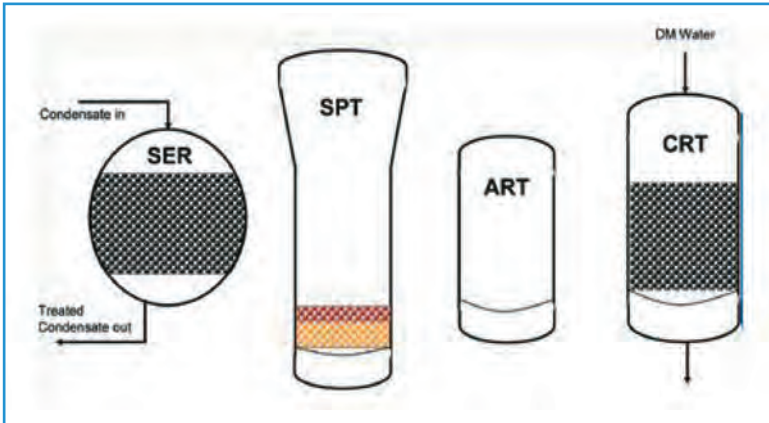

### Step-11 Mixed Resin Storage and Standby

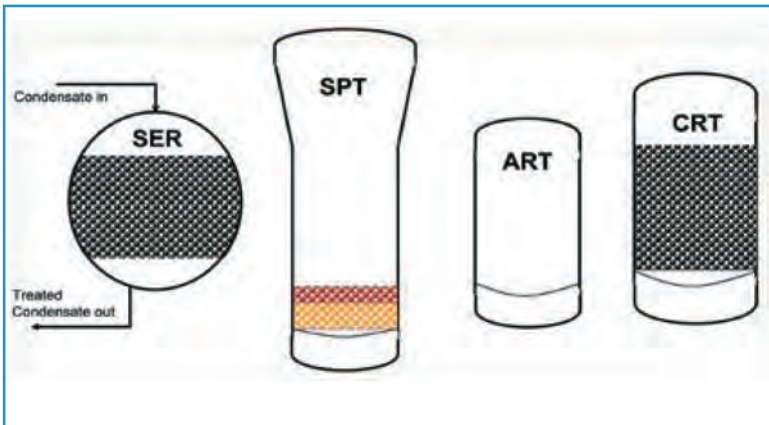

### Step-12 Mixed Resin Transfer from Storage Vessel (CRT) Vessel to Service (SER) Vessel

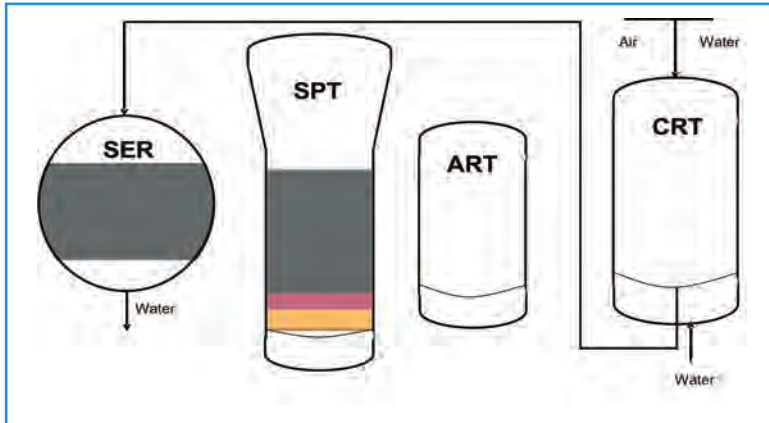

## ANNEXURE - 24

### ESTIMATING WATER BALANCE IN COOLING TOWER

#### 1.0 Estimating Water Balance

Water is lost by three routes

1. Evaporation from tower (E)
2. Drift/Windage, System Losses (W)
3. Deliberate Blowdown (B)

Total Make-up = E+W+B

$E = 0.0018 \times DT \times \text{Recirculation Rate} \times F^*$

$$\text{COC} = \frac{\text{Concentration of impurity in cooling water}}{\text{Concentration of impurity in make-up}}$$

$$\text{COC} = \frac{\text{Make-up Rate}}{\text{Blowdown} + \text{Windage}}$$

$B = E / (\text{COC} - 1)$

$M = E (\text{COC}/\text{COC}-1)$

$F^*$  = Factors depends on seasonal changes in weather

#### Example

Parameters	Unit	Value
Recirculation rate	m <sup>3</sup> /h	5,000
Temperature difference	° C	5
Cycles of concentration	-	5
Evaporation rate	m <sup>3</sup> /h	50
Blowdown	m <sup>3</sup> /h	12.5
Make-up	m <sup>3</sup> /h	62.5
Drift loss	m <sup>3</sup> /h	0.5
Delberate blowdown	m <sup>3</sup> /h	12

## ANNEXURE - 25

### ASME GUIDELINES FOR INDUSTRIAL WATER TUBE BOILERS UPTO 900 PSI WITH SUPER HEATER AND TURBINE DRIVE

Parameters	Unit	< 300 psi	< 450 psi	< 600 psi	<750 psi	<900 psi
Dissolved oxygen	ppb	7	7	7	7	7
Total iron	ppm	< 0.1	< 0.05	< 0.03	< 0.025	< 0.02
Total copper	ppm	< 0.05	< 0.025	< 0.02	< 0.02	< 0.015
Total hardness	ppm	< 0.3	< 0.3	< 0.2	< 0.2	< 0.1
Silica	ppm	< 150	< 90	< 40	< 30	< 20
Total alkalinity	ppm	< 350	< 300	< 250	< 200	< 150
Conductivity	µm	< 5400	< 4600	< 3800	< 1500	< 1200

## ANNEXURE - 26

### PROCEDURE FOR DETERMINATION OF SILT DENSITY INDEX

#### General

Silt Density Index has come to stay as one of the most important feed water limiting parameters that must be considered both during design and commissioning of water treatment/recycle plants based on either RO or NF membranes to minimise operational problems that can occur due to fouling of membranes by finely divided particles present in feed water. A carefully designed pretreatment plant aimed at reducing the SDI to as low a value as possible will go a long way in trouble free operation of the plant.

#### About Silt Density Index

Silt Density Index (SDI) is an empirical test developed for measuring the rate of fouling of nano filtration (NF) or RO membranes. It represents the potential for fouling of the membranes by finely suspended particles present in feed water to the membranes.

There is no direct correlation between turbidity of a water stream and its SDI. Experience has shown that water with a very low turbidity ( $< 1$  NTU) may have a high SDI value. Deep tubewell waters, as a rule, are free from suspended solids and exhibit a low turbidity value/SDI. On the other hand, surface water invariably contains high levels of fine suspended solids and therefore exhibits high turbidity as well as high SDI, calling for extensive pretreatment to achieve acceptable values of SDI and turbidity in feed water.

The measurement, its significance and the interpretation of the results of SDI tests are described below. The equipment used and the procedure (ASTM standard test method D 4189-82) are also given.

#### Measuring SDI

##### Apparatus

The SDI assembly is schematically described in Figure 1. All wetted parts should be made of high quality stainless steel or plastic to prevent contamination by corrosive products. Do not use reactive materials such as carbon steel or cast iron. Suitable filter holders, designed to withstand an operating gauge pressure of 350 kPa (50 psi) can be obtained from suppliers of membrane filters.



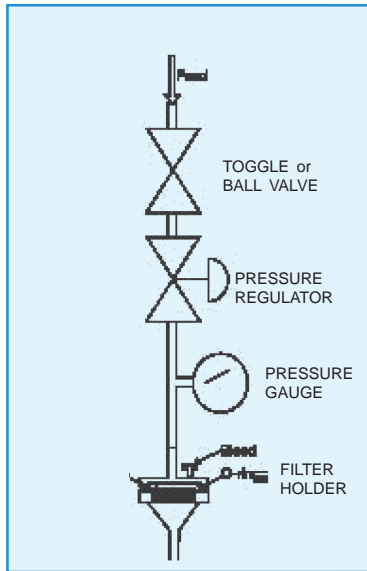

Other components required for the test are as follows:

- Membrane filter, 47 mm in diameter, gridded, and with a mean pore size in the range of  $0.45 \pm 0.02$  micron, inclusive. Use only filters that are packaged in the same orientation
- Graduated cylinder, 500 ml capacity
- Stop watch, graduated in hundredths of a minute
- Thermometer, liquid-in-glass, suitable for measuring the temperature of the water sample, capable of being read within  $\pm 1^\circ\text{C}$

## Test Procedure

The procedure is based on the time required to filter a volume of feed water through a 0.45 micron filter paper at a feed pressure of 30 psig at start and then after 5, 10 and 15 minutes of continuous filtration. If the test is limited to only 5 to 10 minutes reading, due to the plugging of the filter pad one can expect a high level of plugging of the membrane.

1. Assemble the test equipment as per Figure 1.
2. Locate a sample tap on the feed water piping and install the test equipment.
3. Adjust the pressure regulator to 30 psi with a filter pad installed. Use a fresh filter for the actual test.

4. Take the temperature of the feed water. The temperature should not vary more than  $\pm 1^{\circ}\text{C}$  between the start and end of the test.
5. Bleed any entrained air in the filter holder. Depending on the model of the filter holder, either open the bleed valve, or loosen the filter holder while cracking the ball valve. Then close the bleed valve or filter holder.
6. Place the 500 ml graduated cylinder under the filter to measure the amount of water that passes through the filter.
7. Open the ball valve fully, and measure the time required to collect 100 ml and 500 ml from the time the ball valve is opened.  
Record these times, leaving the valve open and letting the flow continue.
8. After 5 minutes, repeat the time measurement required to collect 100 ml and 500 ml samples. Repeat again after 10 and 15 minute intervals.
9. If the time required to obtain a 100 ml sample is greater than 60 seconds, pluggage will be about 90%, and it is not necessary to continue the test.
10. Measure the water temperature again to ensure that it did not vary by more than  $1^{\circ}\text{C}$  from the initial temperature.
11. After completing the test and disconnecting the apparatus, the filter paper may be saved in a plastic bag for future reference.

**Note: For best results**

- Use dull tweezers when positioning the filter to prevent puncturing the filter
- Ensure that the O-ring is clean and in good condition, and is properly positioned
- Avoid touching the filter with fingers
- Flush the apparatus to remove any contaminants that may be in it

### Calculations

$$\text{SDI} = \text{P30} / \text{Tt} = 100 * (1 - \text{Ti} / \text{Tf}) / \text{Tt}$$

Where SDI = Silt Density Index

P30 = % pluggage at 30 psi feed pressure \*\*

Tt = Total test time in minutes (usually 15 minutes, but may be less if 75% pluggage\*\* occurs in less than 15 minutes).

Ti = Initial time in seconds required to obtain sample.

Tf = Time required to obtain sample after 15 minutes (or less).

**Note:**

Time to collect 500 ml should be approximately 5 times greater than the time to collect 100 ml. If 500 ml collection time is much greater than 5X, SDI should be calculated using 100 ml collection times.

For accurate SDI measurements, P30 should not exceed 70%. If P30 exceeds this value, re-run the test and obtain Tf at a shorter time (T).

## Limitations

The test, although popular, is at best an empirical method and its interpretation calls for some expertise on the part of the person carrying out the test.

Feed pressure must always be maintained at around 30 psi as any variation in feed pressure during the run can lead to erroneous results.

SDI may vary with the make of the filter used; hence it is suggested that filter papers of the same make be used for each study.

SDI is also a function of the water temperature and values obtained at different temperatures may not necessarily be comparable.

Temperature should not vary more than  $\pm 1^{\circ}\text{C}$  between the start and end of the run.

## Interpretation of Results

### SDI Value

1. Value higher than 6: Indicative of very high potential for fouling. Do not attempt to continue passing the feed through the membranes till the pretreatment is set right and a value lower than 4 is obtained.
2. SDI Profile: SDI reduction across various equipment like multigrade (MGF), activated (ACF) and cartridge (CF) filter should be checked regularly. The following conclusions can be drawn from the results:
  - i) MGF: SDI reduction across the MGF should be maximum. If no significant SDI reduction is seen across the MGF, this indicates that the size of the particles in the raw water is less than  $25\ \mu\text{m}$ . Hence, coagulants/flocculants should be added to increase the size of the particles and improve the removal efficiency of the MGF.
  - ii) CF: SDI reduction across the CF should be minimum. If a significant reduction in SDI is seen across the CF, it will foul very frequently. The remedy is to improve the particle removal efficiency of the MGF.

3. Colour of filter paper used for SDI test:

i	Slightly yellow	The possible problem could be presence of iron and/or organics in feed water. Check the source for presence of iron and organics in the water source. Also check for possible corrosion in the lines
ii	Reddish brown	Positive indication of presence of iron in feed water. Take corrective steps for removal of iron
iii	Gray	Indicates presence of carbon fines. Check the carbon filter, remove carbon fines
iv	Particles present on the filter paper	Check the cartridge filter and the filter elements
v	Dark black	If the colour dissolves in the acid, it indicates the presence of manganese in the water

### Significance and Use of SDI

1. SDI can serve as a useful indication of the fouling potential due to undissolved particles of the feed water to NF and RO membranes.
2. SDI can be used to ascertain the effectiveness of the pretreatment processes like clarification and filtration.

### Pretreatment Options

Membrane manufacturers and system designers insist that the value for SDI (15 min) of feed water to membranes should be as low as possible and in any case should not exceed 4.0, to minimise fouling of membranes. The index is also used to evaluate the effectiveness of various pretreatment processes like clarification and filtration.

Experience has shown that conventional pretreatment plants using clarification and filtration through granular media are often inadequate in reducing the turbidity and SDI of feed water streams. Industries now rely more on the use of membrane processes like Ultra filtration especially when dealing with industrial effluents or secondary treated municipal sewage as feed water to RO systems for water recovery. Ultra filtration systems have already replaced the conventional pretreatment plants at several industrial installations like Madras Fertilisers Ltd., Chennai and Sundaram Fasteners, Madurai.

The following graph shows SDI reduction through ultra filtration:

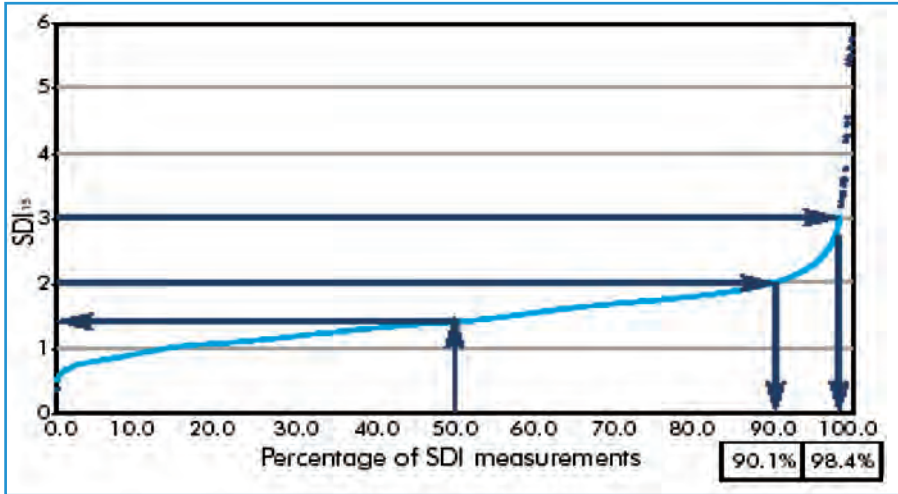

SDI reduction of less than 3.0 is achieved in 98.4% of the cases.

SDI reduction of less than 2.0 is achieved in 90% of the cases.

## ANNEXURE - 27

### SOLUBILITY COMPARISON OF HYDROXIDES AND SULPHIDES OF HEAVY METAL PRECIPITATION

Metal	Solubility of metal ions (mg/l)	
	As Hydroxides	As Sulphides
Iron (Fe <sup>+2</sup> )	$8.9 \times 10^{-1}$	$3.4 \times 10^{-5}$
Cadmium (Cd)	$2.3 \times 10^{-5}$	$6.7 \times 10^{-10}$
Copper (Cu)	$2.2 \times 10^{-2}$	$5.8 \times 10^{-18}$
Lead (Pb)	2.1	$3.8 \times 10^{-9}$
Mercury (Hg)	$3.9 \times 10^{-4}$	$9.0 \times 10^{-20}$
Nickel (Ni)	$6.9 \times 10^{-3}$	$6.9 \times 10^{-8}$
Zinc (Zn)	1.1	$2.3 \times 10^{-7}$

#### Reference

Handbook of Chemistry and Physics 50<sup>th</sup> Edition A.C. West 1969, P.B. 252

Handbook of Analytical Chemistry, L. Meites, 1963, p.p. 1-15 to 1 – 19 Ionic

Equilibrium as applied to chemical analysis

Hongness & Johnson, 1954, P.P. 360 – 362

## ANNEXURE - 28

### PERMISSIBLE WATER QUALITY STANDARDS FOR DISPOSAL OF TREATED WASTE WATER

The CPCB has developed National Standards for Effluent under the statutory powers of the Water (Prevention and Control of Pollution) Act, 1947. These standards have been approved and notified by the Government of India, Union Ministry of Environment and Forests (MoEF), under section 25 of the Environment (Protection) Act, 1986. Effluent standards for 29 parameters have been evolved and notified and are listed in the table below. These standards are for disposing effluent on land (irrigation, water recharge), in water bodies and public sewers.

The World Health Organization (WHO) recommends that treated waste water for unrestricted irrigation should contain less than 1,000/100 ml faecal coliform and less than one helminth egg per litre. This limit should be observed strictly since the risk of transmitting parasites is relatively high.

Disposal Standards of CPCB for Quality of Treated Waste water

Parameter	Unit	On land for irrigation Indian Standards: 3307 (1974)	Into inland surface waters Indian standards : 2490 (1974)	Into public sewers Indian standards: 3306 (1974)
pH	-	5.5 - 9.0	5.5 - 9.0	5.5 - 9.0
BOD (for five days at 20° C)	mg/l	100	30	350
COD	mg/l	-	250	-
Suspended solids	mg/l	200	100	600
Total dissolved solids (inorganic)	mg/l	2100	2100	2100
Temperature (°C)	°C	-	40	45
Oil and grease	mg/l	10	10	20
Phenolic compounds	mg/l	-	1	5
Cyanides	mg/l	0.2	0.2	2
Sulphides	mg/l	-	2	-
Fluorides	mg/l	-	2	15
Total residual chlorine	mg/l	-	1	-

Parameter	Unit	On land for irrigation Indian Standards: 3307 (1974)	Into inland surface waters Indian standards : 2490 (1974)	Into public sewers Indian standards: 3306 (1974)
Pesticides	mg/l	-	-	-
Arsenic	mg/l	0.2	0.2	0.2
Cadmium	mg/l	-	2	1
Chromium (hexavalent)	mg/l	-	0.1	2
Copper	mg/l	-	3	3
Lead	mg/l	-	0.1	1
Mercury	mg/l	-	0.01	0.01
Nickel	mg/l	-	3	3
Selenium	mg/l	-	0.05	0.05
Zinc	mg/l	-	5	15
Chlorides	mg/l	600	1000	1000
Boron	mg/l	2	2	2
Sulphates	mg/l	1000	1000	1000
Sodium (9%)	mg/l	60	-	60
Ammoniacal nitrogen	mg/l	-	50	50
Radioactive materials				
Alpha emitters (milli-curie/ml)		10-8	10-7	10-7
Beta emitters (micro-curie/ml)		10-7	10-6	10-6



## ANNEXURE - 29

### REQUIREMENTS FOR WATER AT THE POINT OF DISTRIBUTION IN THE ELECTRONICS AND SEMICONDUCTOR INDUSTRIES

Parameter	Type E-1	Type E-1.1	Type E-1.2	Type E-2	Type E-3	Type E-4
Linewidth (microns)	1.0–0.5	0.35–0.25	0.18–0.09	5.0–1.0	>5.0	—
Resistivity, 25°C (On-line)	18.1	18.2	18.2	16.5	12	0.5
TOC (µg/l) (on-line for <10 ppb)	5	2	1	50	300	1000
On-line dissolved oxygen (µg/l)	25	10	3	—	—	—
On-Line Residue after evaporation (µg/l)	1	0.5	0.1	—	—	—
<b>On-line particles/L (micron range)</b>						
0.05–0.1		1,000	200	—	—	—
0.1–0.2	1,000	350	<100	—	—	—
0.2–0.5	500	<100	<10	—	—	—
0.5–1.0	200	<50	<5	—	—	—
1.0	<100	<20	<1	—	—	—
<b>SEM particles/L (micron range)</b>						
0.1–0.2	1,000	700	<250	—	—	—
0.2–0.5	500	400	<100	3,000	—	—
0.5–1	100	50	<30	—	10,000	—
10	<50	<30	<10	—	—	100,000
<b>Bacteria in CFU/Volume</b>						
100 ml Sample	5	3	1	10	50	100
1 L Sample			10			
Silica – total (µg/l)	5	3	1	10	50	1,000
Silica – dissolved (µg/l)	3	1	0.5	—	—	—
<b>Anions and Ammonium by IC (µg/l)</b>						
Ammonium	0.1	0.10	0.05	—	—	—
Bromide	0.1	0.05	0.02	—	—	—
Chloride	0.1	0.05	0.02	1	10	1,000

Parameter	Type E-1	Type E-1.1	Type E-1.2	Type E-2	Type E-3	Type E-4
Fluoride	0.1	0.05	0.03	—	—	—
Nitrate	0.1	0.05	0.02	1	5	500
Nitrite	0.1	0.05	0.02	—	—	—
Phosphate	0.1	0.05	0.02	1	5	500
Sulphate	0.1	0.05	0.02	1	5	500
<b>Metals by ICP/MS (µg/l)</b>						
Aluminum	0.05	0.02	0.005	—	—	—
Barium	0.05	0.02	0.001	—	—	—
Boron	0.3	0.1	0.05	—	—	—
Calcium	0.05	0.02	0.002	—	—	—
Chromium	0.05	0.02	0.002	—	—	—
Copper	0.05	0.02	0.002	1	2	500
Iron	0.05	0.02	0.002	—	—	—
Lead	0.05	0.02	0.005	—	—	—
Lithium	0.05	0.02	0.003	—	—	—
Magnesium	0.05	0.02	0.002	—	—	—
Manganese	0.05	0.02	0.002	—	—	—
Nickel	0.05	0.02	0.002	1	2	500
Potassium	0.05	0.02	0.005	2	5	500
Sodium	0.05	0.02	0.005	1	5	1,000
Strontium	0.05	0.02	0.001	—	—	—
Zinc	0.05	0.02	0.002	1	5	500

## ANNEXURE - 30

### WASTE WATER TREATMENT - TERMS AND DEFINITIONS

#### Activated Sludge Process (ASP)

A reactor in which the microorganism is responsible for treatment are kept in suspension and aerated. Post ASP liquid solids separation takes place in a sedimentation tank (clarifier) that has a recycled system for returning solids removed from liquid solids separation unit back to reactor.

#### Aeration

The process whereby water is brought into intimate contact with air by spraying or cascading, or air is brought into intimate contact with water by an air aspirator or by bubbling compressed air, through the body of water. Both pressure (closed) aerator and open (gravity) aerators are used. Closed aeration is used chiefly for oxidation, open aeration for degassing.

#### Aeration Liquor

Mixed liquor. The contents of the aeration tank including living organisms and material carried into the tank by either untreated waste water or primary effluent.

#### Aeration Tank

The tank where raw or settled waste water is mixed with return sludge and aerated. The same as aeration bay, aerator or reactor.

#### Aerobic Bacteria

Bacteria which will live and reproduce only in an environment containing oxygen which is available for their respiration (breathing), namely atmospheric oxygen or oxygen dissolved in water. Oxygen combined chemically, such as in water molecules (carbon dioxide), cannot be used for respiration by aerobic bacteria.

#### Aerobic Decomposition

The decay or breaking down of organic material in the presence of free or dissolved oxygen.

## **Aerobic Digestion**

The breakdown of wastes by microorganisms in the presence of dissolved oxygen. Waste sludge is placed in a large aerated tank where aerobic microorganisms decompose the organic matter in the sludge. This is an extension of the activated sludge process.

## **Aerobic Process**

A waste treatment process conducted under aerobic (in the presence of free or dissolved oxygen) conditions.

## **Algae**

Algae are photosynthetic chlorophyll containing organisms that occur in moist habitat. They vary from single cell forms to multicellular forms.

## **Biochemical Oxygen Demand (BOD) Test**

A procedure that measures the rate of oxygen use under controlling conditions of time and temperature. Standard test conditions include dark incubation at 20°C for a specified time (usually five days).

## **Biochemical Oxygen Demand (BOD)**

The rate at which microorganisms use the oxygen in water or waste water while stabilising decomposable organic matter under aerobic conditions. In the decomposition, organic matter serves as food for the bacteria and energy results from its oxidation.

## **Biodegradable**

Organic matter that can be broken down by bacteria to more stable forms which will not create a nuisance or give off foul odours.

## **Biomass**

A mass or clump of living organisms feeding on the wastes in waste water, dead organisms and other debris. This mass may be formed for, or function as, the protection against predators and storage of food supplies.

## **Break Point Chlorination**

Addition of chlorine to waste or waste water until the chlorine demand has been

satisfied and further additions of chlorine result in a residual that is directly proportional to the amount added beyond the break point.

## Bulking Sludge

Phenomena where MLSS with poor settling characteristics is developed resulting in high effluent suspended solids and poor treatment performance.

## Chemical Oxygen Demand (COD)

A measure of the oxygen-consuming capacity of inorganic and organic matter present in waste water. COD is expressed as the amount of oxygen consumed from a chemical oxidant in mg/L during a specific test. Results are not necessarily related to the Biochemical Oxygen Demand (BOD) because the chemical oxidant may react with substances that bacteria do not stabilise.

## Chlorine Demand

Chlorine demand is the difference between the amount of chlorine added to waste water and the amount of residual chlorine remaining after a given contact time. Chlorine demand may change with dosage time, temperature, pH, and nature and amount of the impurities in the water.

Chlorine Demand, mg/l

Chlorine Applied, mg/l

Chlorine Residual, mg/l

## Coliform

One type of bacteria. The presence of coliform group bacteria is an indication of possible pathogenic bacterial contamination. The human intestinal tract is one of the main habitats of coliform bacteria. They may also be found in the intestinal tracts of warm-blooded animals, and in plants, soil, air and the aquatic environment. Faecal coliforms are those coliforms found in the faeces of various warm-blooded animals; whereas the term “coliforms” also includes other environmental sources.

## Colloids

Very small, finely divided solids (particles that do not dissolve) that remain dispersed in a liquid for a long time due to their small size and electrical charge.

## Contact Stabilisation

Contact stabilisation is a modification of the conventional activated sludge process. In contact stabilisation, two aeration tanks are used. One tank is for separate re-aeration of the return sludge for at least four hours before it is permitted to flow into the other aeration tank to be mixed with the primary effluent requiring treatment.

## Denitrification

A condition that occurs when nitrate or nitrite ions are reduced to nitrogen gas and bubbles are formed as a result of this process. The bubbles attach to the biological flocs and float the flocs to the surface of the secondary clarifiers. This condition is often the cause of rising sludge observed in secondary clarifier.

## Detritus

The heavy, coarse mixture of grit and organic material carried by waste water.

## Diffused Air Aeration

A diffused air activated sludge plant takes air, compresses it, and then discharges the air below the water surface of the aerator through some type of air diffusion device.

## Disinfection

The process designed to kill most microorganisms in waste water, including essentially all pathogenic (disease causing) bacteria. There are several ways to disinfect, with chlorine being most frequently used in water and waste water treatment plants.

## Elutriation

The washing of digested sludge in plant effluent. The objective is to remove (wash out) fine particulates and /or alkalinity in sludge. This process reduces the demand for conditioning chemicals and improves settling of filtering characteristics of the solids.

## Endogenous

A reduced level of respiration (breathing) in which organisms break down compounds within their own cells to produce the oxygen they need.

## Equalising Basin

A holding basin in which variations in flow and composition of liquid are averaged. Such basins are used to provide a flow of reasonably uniform volume and composition to a treatment unit. Also called a balancing reservoir.

## F/M Ratio

Food to microorganism ratio. A measure of food provided to bacteria in an aeration tank.

$$\begin{aligned} & \frac{\text{Food}}{\text{Microorganisms}} - \frac{\text{BOD, 1bs/day}}{\text{MLVSS, 1bs}} \\ = & \frac{\text{Flow, MGD} \times \text{BOD, mg/l} \times 8.34 \text{ 1bs/gal}}{\text{Volume, MG} \times \text{MLVSS, mg/l} \times 8.34 \text{ 1bs/gal}} \\ = & \frac{\text{BOD, kg/day}}{\text{MLVSS, kg}} \end{aligned}$$

## Facultative

Facultative bacteria can use either molecular (dissolved) oxygen or oxygen obtained from food materials such as Sulphate or nitrate ions. In other words, facultative bacteria can live under aerobic or anaerobic conditions.

## Filamentous Bacteria

Organisms that grow in a thread or filamentous form.

## Food/Microorganism Ratio

Food to microorganisms ratio. A measure of food provided to bacteria in an aeration tank.

See F/M Ratio above.

## Free Available Chlorine

The amount of chlorine available in water. This chlorine may be in the form of dissolved gass ( $\text{Cl}_2$ ), hypochlorous acid ( $\text{HOCl}$ ), or hypochlorite ion ( $\text{OCl}$ ), but does not include chlorine combined with an amine (ammonia or nitrogen) or other organic compound.

## Free Available Residual Chlorine

That portion of the total residual chlorine remaining in water or waste water at the end of a specified contact period. Residual chlorine will react chemically and biologically as hypochlorous acid (HOCl) or hypochlorite ion (OCl<sup>-</sup>).

## Free Chlorine

Free chlorine is chlorine (Cl<sub>2</sub>) in a liquid or gaseous form. Free chlorine combines with water to form hypochlorous (HOCl) and hydrochloric acids (HCl). In waste water free chlorine usually combines with an amine (ammonia or nitrogen) or other organic compounds to form combined chlorine compounds.

The application of chlorine or chlorine compounds to water or waste water to produce a free available chlorine residual directly or through the destruction of ammonia (NH<sub>3</sub>) or certain organic nitrogenous compounds.

## Grit

The heavy mineral material present in waste water, such as sand, eggshells, gravel, and cinders.

## Grit Removal

Grit removal is accomplished by providing an enlarged channel or chamber which causes the flow velocity to be reduced and allows the heavier grit to settle to the bottom of the channel where it can be removed.

## Hydraulic Loading

Hydraulic loading refers to the flows (MGD or cu.m/day) to a treatment plant or treatment process. Detention times, surface loadings and weir over flow rates are directly influenced by flows.

## Imhoff Cone

A clear, cone-shaped container marked with graduations. The cone is used to measure the volume of settleable solids in a specific volume of waste water.

## Incineration

The conversion of dewatered sludge cake by combustion (burning) to ash, carbon dioxide and water vapour.



## Jar Test

A laboratory procedure that simulates coagulation/flocculation with differing chemical doses. The purpose of the procedure is to estimate the minimum coagulant dose required to achieve certain water quality goals. Samples of water to be treated are placed in six jars. Various amounts of chemicals are added to each jar, stirred and the settling of solids is observed. The lowest dose of chemicals that provides satisfactory settling is the dose used to treat the water.

## Kjeldahl Nitrogen

Organic and ammonia nitrogen.

## Launders

Sedimentation tank effluent troughs.

## M or Molar

A molar solution consists of one gram molecular weight of a compound dissolved in enough water to make one litre of solution. A gram molecular weight is the molecular weight of a compound in grams. For example, the molecular weight of sulfuric acid is 98. A 1M solution of sulfuric acid would consist of 98 grams of sulfuric acid dissolved in enough distilled water to make one litre of solution.

## MPN

MPN is the Most Portable Number of coliform group organisms per unit volume. Expressed as a density, or population of organisms per 100 ml.

## Mean Cell Residence Time

An expression of the average time that a microorganism will spend in the activated sludge process.

$$\text{MCRT, days} = \frac{\text{Solids in Activated Sludge Process, 1bs}}{\text{Solids Removed from Process, 1bs/day}}$$

## Mechanical Aeration

The use of machinery to mix air and water so that oxygen can be absorbed or dissolved into the water. Some examples are: paddle wheels, mixers, or

rotating brushes to agitate the surface of an aeration tank; pumps to create fountains; and pumps to discharge water down a series of steps forming falls or cascades.

### **Mesophilic Bacteria**

Medium temperature bacteria. A group of bacteria that grow and thrive in a moderate temperature range between 68° F (20° C) and 113° F (45° C). The optimum temperature range for these bacteria in anaerobic digestion is 85° F (30° C) to 100° F (38° C).

### **Micron**

A unit of length. One millionth of a metre or one thousandth of a millimetre. One micron equals 0.00004 of an inch.

### **Milligrams Per Litre**

A measure of the concentration by weight of a substance per unit volume, for practical purposes, one mg/L is equal to one part per million parts (ppm). Since one litre of water weigh one million milligrams, one ppm equals to one milligram per litre (mg/l).

### **Mixed Liquor**

When the activated sludge in an aeration tank is mixed with primary effluent or the raw waste water and return sludge, this mixture is then referred to as mixed liquor as long as it is in the aeration tank. Mixed liquor also may refer to the contents of mixed aerobic or anaerobic digesters.

### **Mixed Liquor Suspended Solids**

Suspended solids in the mixed liquor of an aeration tank.

### **Mixed Liquor Volatile Suspended Solids**

The organic or volatile suspended solids in the mixed liquor of an aeration tank.

### **N or Normal**

A normal solution contains one gram equivalent weight of a reactant (compound) per litre of solution. The equivalent weight of an acid is that weight which

contains one gram atom of ionizable hydrogen or its chemical equivalent. For example, the equivalent weight of sulfuric acid ( $\text{H}_2\text{SO}_4$ ) is 49 (98 divided by 2 because there are two replaceable hydrogen ions). A 1 N solution of sulfuric acid would consist of 49 grams of  $\text{H}_2\text{SO}_4$  dissolved in enough water to make to one litre of solution.

## Nitrification

The biochemical transformation of ammonium nitrogen to nitrate nitrogen.

## Nitrifying Bacteria

Bacteria that change the ammonia and organic nitrogen in waste water into oxidised nitrogen (usually nitrate).

## Overflow Rate

One of the guidelines for the design of settling tanks and clarifiers in treatment plants

$$\text{Overflow Rate, m}^3/\text{h/m}^2 = \frac{\text{Flow, m}^3/\text{h}}{\text{Surface Area, m}^2}$$

## Oxidation-reduction potential

The electrical potential required to transfer electrons from one compound or element (the oxidant) to another compound or element (the reductant); used as a qualitative measure of the state of oxidation in waste water treatment systems.

## Parasitic Bacteria

Parasitic bacteria are those bacteria which normally live off another living organism known as the host.

## Pathogenic Organisms

Bacteria viruses or cysts can cause disease such as typhoid, cholera, dysentery. There are many types of bacteria which do not cause disease and which are not called pathogenic. Many beneficial bacteria are found in waste water treatment processes actively cleaning up organic wastes.

## Percent Saturation

The amount of a substance that is dissolved in a solution compared with the amount that could be dissolved in the solution expressed as a percentage.

$$\text{Percentage Saturation, \%} = \frac{\text{Amount of sub. that is dissolved} \times 100 \%}{\text{Amount that could be dissolved in solution}}$$

## pH

pH is an expression of the intensity of the alkaline or acid condition of a liquid. Mathematically pH is the logarithm (base 10 ) of the reciprocal of the hydrogen ion concentration.

$$\text{pH} = \text{Log} \frac{1}{(\text{H}^+)}$$

The pH may range from 0 to 14, where 0 is most acid, 14 most alkaline, and 7 is neutral. Natural waters usually have a pH between 6.5 and 8.5.

## Phenolphthalein Alkalinity

A measure of the hydroxide ions plus one half of the normal carbonate ions aqueous suspension. Measured by the amount of sulfuric acid required to bring the water to a pH value of 8.3, as indicated by a change in color of phenolphthalein. It is expressed in milligrams per litre of equivalent calcium carbonate.

## Polyelectrolyte

A polymeric electrolyte (natural or synthetic) with a long chain like structure and a high molecular weight, which may be used as a cationic, anionic or nonionic flocculent (or coagulant aid) in the treatment of potable water. Often called a polymer.

## Recarbonation

A process in which carbon dioxide is bubbled into the water being treated to lower the pH. The pH may also be lowered by addition of acid. Recarbonation is the final stage in the lime soda ash softening process. The process converts carbonate ions to bicarbonate ions and stabilises the solution against the precipitation of carbonic compounds.

## Refractory Materials

Resistant, under ordinary or various extraordinary conditions, to treatment or to change in chemical structure, such as resisting or being capable of enduring high temperature or biological process without breaking down or decomposing.

## Residual Chlorine

Residual chlorine is the amount of chlorine remaining after a given contact time and under specific conditions.

## Respiration

The process in which an organism uses oxygen for its life processes and gives off carbon dioxide.

## Detention Time

The actual time that a small amount of water is in settling basin, flocculating basin or rapid mix chamber.

$$\text{Detention Time (hours)} = \frac{\text{Basin Volume (m}^3\text{)} (24 \text{ h/day})}{\text{Flow (m}^3\text{/day)}}$$

## Rotifers

Microscopic animals characterised by short hairs on their front end.

## SVI (Sludge Volume Index)

This is a test used to indicate the settling ability of activated sludge (aerated solids) in the secondary clarifier. The test is a measure of the volume of sludge compared with its weight. Allow the sludge sample from the aeration tank to settle for 30 minutes. Then calculate SVI by dividing the volume (ml) of wet settled sludge by the weight (mg) of that sludge after it has been dried. Sludge with an SVI of one hundred or greater will not settle as readily as described because it is as light as or lighter than water.

$$\text{SVI} = \frac{\text{Wet Settled Sludge, ml} \times 1,000}{\text{Dried Sludge Solids, mg}}$$

## Population Equivalent

A unit measure used to express the strength of waste water from any source (That is not from household waste water only). In making such calculations, 0.077 kgs of BOD (Biological Oxygen Demand) per capita per day is often used as the standard figure. Thus waste water with 7.701 kgs of BOD per day would have a population equivalent of  $7.701 \div 0.077$  or 100 people.

## Post-Chlorination

The application of chlorine to water following other water treatment process.

## Prechlorination

The application of chlorine to a water supply prior to other water treatment processes which may follow.

## Protozoa

Microscopic, usually singled-celled microorganisms which live in water and are relatively larger in comparison to other microbes.

## Psychrophilic Bacteria

Cold temperature bacteria, a group of bacteria that grow and thrive in temperature range between 12° C - 18° C (optimum range).

## Putrefaction

Biological decomposition of organic matter with the production of ill-smelling and tasting products associated with anaerobic (no oxygen present) conditions.

## Recalcine

A lime-recovery process in which the calcium carbonate in sludge is converted to lime by heating at 1800° F (980° C).

## Sodium Adsorption Ratio (SAR)

This ratio expresses the relative activity of sodium ions in the exchange reactions with soil indicating the sodium or alkali hazard to soil. The ratio is defined as follows:

$$\text{SAR} = \frac{[\text{Na}^+]}{\sqrt{0.5 ([\text{Ca}^{2+}] + [\text{Mg}^{2+}])}}$$

Where

[Na<sup>+</sup>] = Sodium ion concentration

[Ca<sup>2+</sup>] = Calcium ion concentration

[Mg<sup>2+</sup>] = Magnesium ion concentration

### Stabilised Waste

A waste that has been treated or decomposed to the extent that, if discharged or released, its rate and state of decomposition would be such that the waste would not cause a nuisance or odors.

### Suction Head

The pressure [in feet (metres) or pounds per square inch (kilograms per square centimetre)] on the suction side of the pump. The pressure can be measured from the center line of the pump upto the elevation of the hydraulic grade line on the suction side to the pump.

### Surface Loading

One of the guidelines for the design of settling tanks and clarifiers in treatment plants. Used by operators to determine if tanks and clarifiers are hydraulically (flow) overloaded or under loaded. Also called overflow rate.

$$\text{Surface Loading, m}^3/\text{h/m}^2 = \frac{\text{Flow, m}^3/\text{h}}{\text{Surface Area, m}^2}$$

### Secondary Treatment

The process which makes up the second step in treating waste water and removes suspended and dissolved solids and biochemical oxygen demand (BOD) from the waste water which has already undergone primary treatment.

### Seed Sludge

In waste water treatment, seed, seed culture or seed sludge refers to a mass of sludge which contains very concentrated populations of microorganisms. When a seed sludge is mixed with the waste water or sludge being treated, the process of biological decomposition takes place more rapidly.

## Septic

A condition produced by bacteria when all oxygen supplies are depleted. If sewage, water turns black, it produces foul odour, and the water requires an increased amount of chlorine.

## Sewage

Sewage is the combination of liquids or water carrying wastes from homes, business spaces, institutions and industries.

## Silt Density Index (SDI)

A test used to measure the level of suspended solids in feed water for membrane filtration systems. The test consists of the time it take to filter 500 millilitres of test water through a 47 millimetre diameter, 0.45 micron rated microporous filter under a constant pressure of 30 psig, at the beginning of a test filtration period (commonly 15 minutes of total filtration time) compared to the time it takes to filter 500 millimetre at the end of the test period. The SDI of feed water to a reverse osmosis membrane should be maintained at less than 5, preferably less than 3.3.

$$SDI = \frac{100 (1 - \frac{t_1}{t_2})}{T}$$

$t_1$  = time to filter 500 ml of water initially

$t_2$  = time to filter 500 ml of water after T minutes (T is usually 15 minutes)

## Sludge Digestion

The process of changing organic matter in sludge into a gas or a liquid or a more stable solid form. These changes take place as microorganisms feed on sludge in anaerobic (more common) or aerobic digesters.

## Sludge Volume Ratio (SVR)

The volume of sludge blanket divided by the daily volume of sludge pumped from the thickener.

## Total Organic Carbon (TOC)

The amount of carbon covalently bound in organic compounds in a water sample. TOC is measured by the amount of carbon dioxide produced when a water sample is atomised in a combustion chamber.



## Tertiary Treatment

The third stage of treatment that brings water to a high degree of refinement or conditioning following the reduction of substance in the primary and secondary stages of treatment.

## Thermophilic Bacteria

A group of bacteria that grow and thrive in temperatures range 55° C – 65° C (optimum).

## Turbidity Units

Turbidity units are used to measure amounts of small particles of solid matter in water.

Turbidity units, if measured by nephelometric (reflected light) instrumental procedure, are expressed in nephelometric turbidity units (NTU). Those turbidity units obtained by other instrumental methods or visual methods are expressed in Jackson Turbidity Units (JTU) and sometimes as Formazin Turbidity Units (FTU). The FTU nomenclature comes from the Formazin polymer used to prepare the turbidity standards for instrument calibration. Turbidity units are a measure of the cloudiness of water.

## Waste Water

The used water and solids from a community or industry that flow to a treatment plant. Storm water, surface water and groundwater infiltration also may be included in the waste water that enters a treatment plant. The term “sewage” refers to household wastes and the “effluent” refers to industrial wastes generally.

## Weir

A wall or plate placed in an open channel and used to measure the flow. The depth of the flow over the weir can be used to calculate the flow rate, a chart or conversion table may be used.

**INDION** is the registered trademark of Ion Exchange (India) Limited.